



MSC

DENTAL INNOVATIONS

A CATALOG OF MODERN TECHNIQUES

www.modern-surgical.com

MSC



mold metal for **healthcare.**

TABLE OF CONTENT

01

FORCEPS

- » Extraction Forceps
- » Root Fragment Forceps

40

ELEVATORS

- » Root and Luxating Elevators

71

SCALPELS

- » Scalpel Handles and Blades

78

SCISSORS

- » Micro Scissors
- » Surgical Scissors
- » Ligature Scissors
- » Wire and Plate

106

TWEEZERS

- » Micro Forceps
- » Titanium Forceps
- » Dressing Forceps
- » Endo Forceps
- » Tissue Forceps
- » TC Forceps
- » Membrane

133

DRIVERS

- » Needle Holders

155

HEMOSTATS / GRASPING FORCEPS

- » Towel Clamps
- » Sponge and Dressing Forceps
- » Hemostatic Forceps
- » Tissue Grasping Forceps

166

RETRACTORS

- » Retractors
- » Mouth Gags and Tongue Depressors
- » Mouth Props

187

IMPLANTOLOGY

- » Osteotomes and Chisels
- » Mallets
- » Periosteals
- » Trephines
- » Periosteals
- » Osteotomes
- » Trephines
- » Bone and Tissue Harvest Accessories
- » Measuring Instruments
- » Bone Holding Forceps

210

PERIOSTEALS / CURETTES / BONE

- » Periosteal Elevators
- » Curettes
- » Bone Files
- » Tissue Nippers
- » Bone Rongeurs
- » Bone Cutting Forceps

235

PERIODONTICS / ENDODONTICS / RESTORATION

- » Periodontics
- » Endodontics
- » Diagnostic
- » Curettes and Scalers
- » Amalgam
- » Composite
- » Spatulas
- » Filling
- » Dental Restoration
- » Perio Chisels & Knives
- » Perio Probes & Explorers
- » Filling
- » Curettes and Scalers
- » Rubber-Dam

300

CROWN & BRIDGE

- » Crown and Bridge Instruments

MSK

FORCEPS



Extracting Forceps, English Pattern

Zahnzangen, Englische Form
 Pinze per estrazione, Forma Inglese
 Pinzas da extracci6n, Forma Inglesa
 Daviers, Forme Anglaise

Forceps

Pinzetten
 Pinzas
 Pincas
 Pinzei

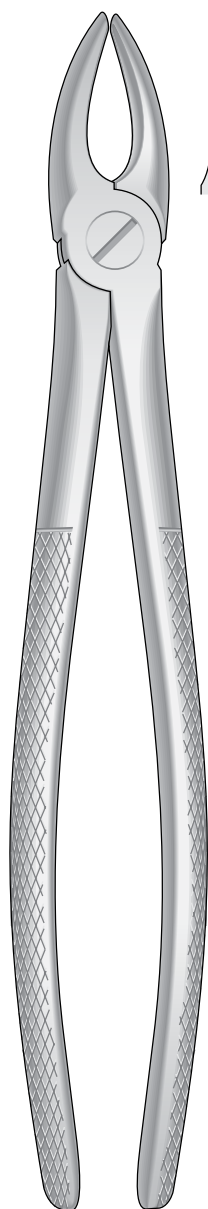

1

Fig. 1

Obere Schneide- und Eckzähne
 Upper Incisors and cuspids
 Incisivi e canini superiori
 Incisivos y caninos superiores
 Incisives et canines supérieures

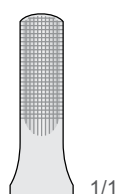

1/1

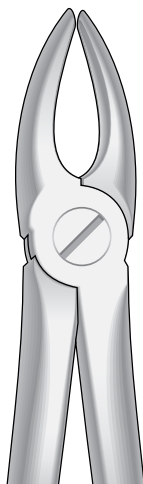

2

Fig. 2

Obere Schneide- und Eckzähne
 Upper Incisors and cuspids
 Incisivi e canini superiori
 Incisivos y caninos superiores
 Incisives et canines supérieures

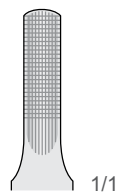

1/1

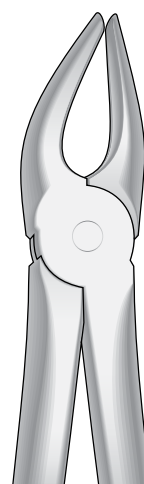

7

Fig. 7

Obere Prämolaren
 Upper premolars
 Premolari superiori
 Premolares superiores
 Prémolaires supérieures

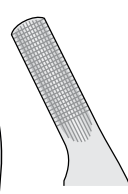

1/1

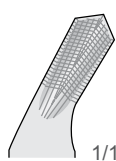

1/1

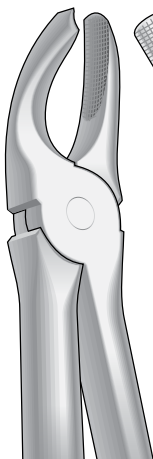

17

Fig. 17

Obere Molaren, rechts
 Upper molars, right
 Molari superiori, destra
 Molares superiores, derechos
 Molaires supérieures, droites

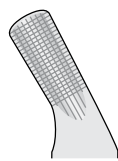

1/1

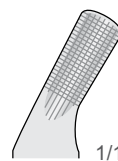

1/1

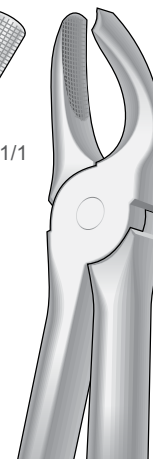

18

Fig. 18

Obere Molaren, links
 Upper molars, left
 Molari superiori, sinistra
 Molares superiores, izquierdos
 Molaires supérieures, gauches

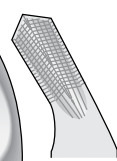

1/1



Extracting Forceps, English Pattern

Zahnzangen, Englische Form

Pinze per estrazione, Forma Inglese

Pinzas da extracción, Forma Inglesa

Daviers, Forme Anglaise

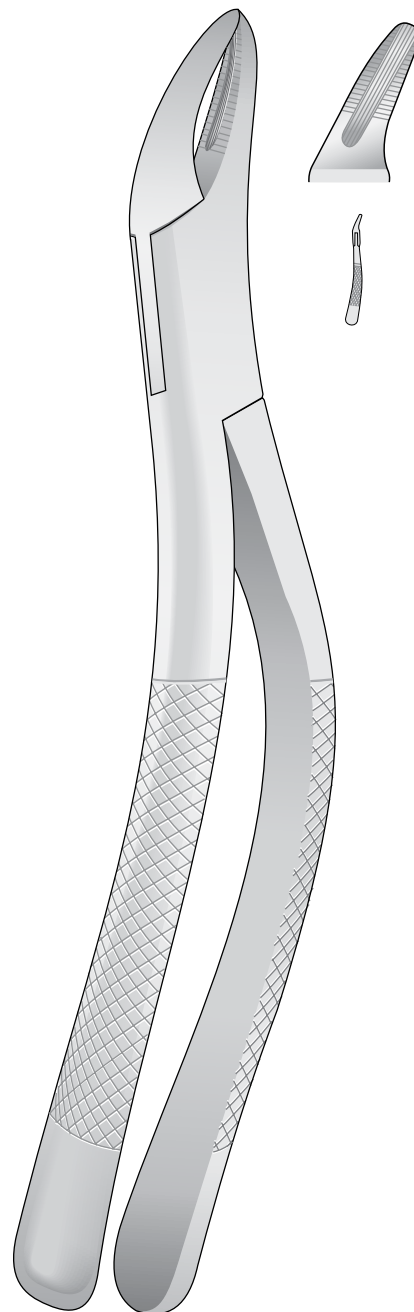
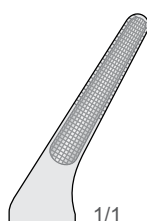
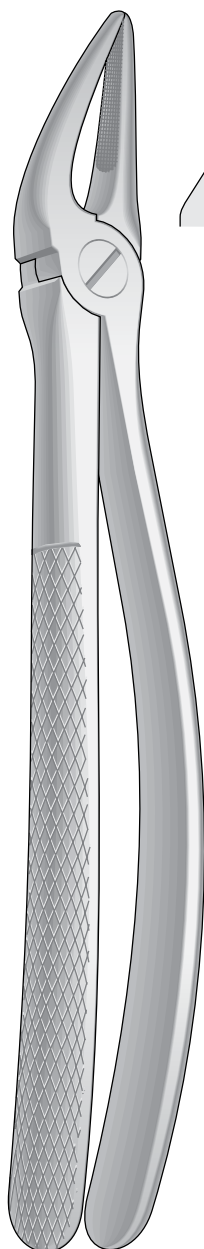
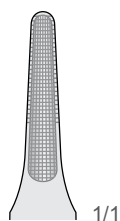
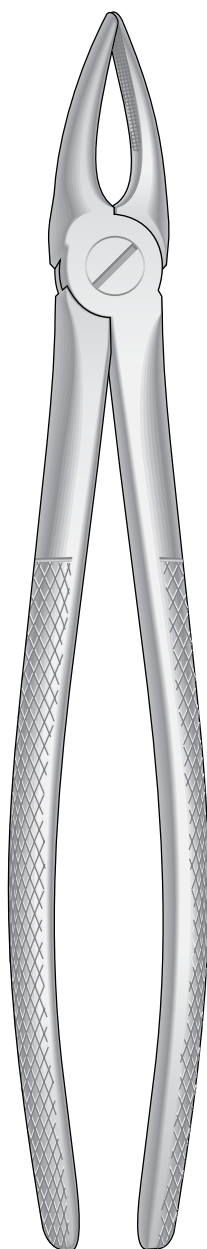

76S
Fig. 76

29

Fig. 29

Obere Wurzeln und Schneidezähne

Upper Roots and incisors

Radici e incisivi superiori

Raíces y incisivos superiores

Racines et incisives supérieures

30

Fig. 30

Obere Wurzeln

Upper Roots

Radici superiori

Raíces superiores

Racines supérieures

Obere Schneidezähne, Prämolaren, Wurzeln

Upper incisors, premolars, roots

Incisivi, premolari e radici superiori

Incisivos, premolares y raíces superiores

Incisives, premolaires et racines supérieures

Extracting Forceps, English Pattern

Zahnzangen, Englische Form
Pinze per estrazione, Forma Inglese
Pinzas da extracción, Forma Inglesa
Daviers, Forme Anglaise

Forceps

Pinzetten
Pinzas
Pinces
Pinzei

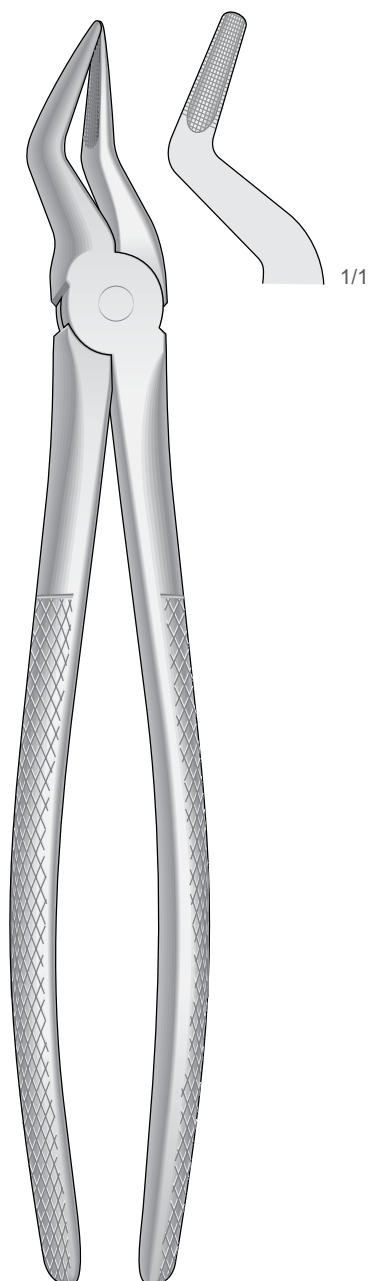

51
Fig. 51
Obere Wurzeln
Upper Roots
Radici superiori
Raíces superiores
Racines supérieures

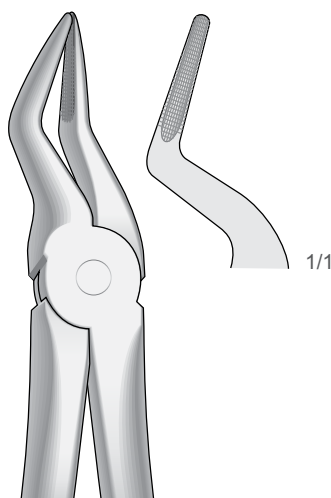

51A
Fig. 51A
Obere Wurzeln
Upper Roots
Radici superiori
Raíces superiores
Racines supérieures

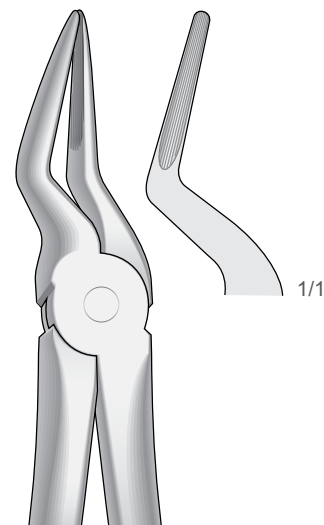

51L
Fig. 51AL
Obere Wurzeln
Upper Roots
Radici superiori
Raíces superiores
Racines supérieures

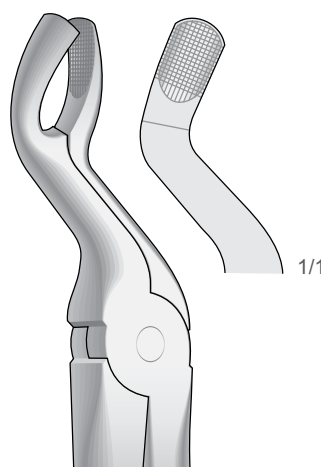

67A
Fig. 67A
Obere Dritte Molaren - Für Obere Weisheitszähne
Upper molars - For Upper wisdom teeth
Ottavi superiori - Per denti del giudizio superiori
Molares superiores - Para muelas del juicio superiores
Molaires supérieures - Pour dents de sagesse supérieures

Extracting Forceps, English Pattern

Zahnzangen, Englische Form

Pinze per estrazione, Forma Inglese

Pinzas da extracci6n, Forma Inglesa

Daviers, Forme Anglaise

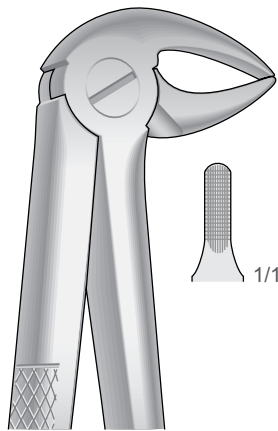

33
Fig. 33

Untere Prämolaren, Schneidezähne und Wurzeln
Lower incisors, premolars and roots
Incisivi, premolari e radici inferiori
Incisivos, premolares y raíces inferiores
Incisives, prémolaires et racines inférieures

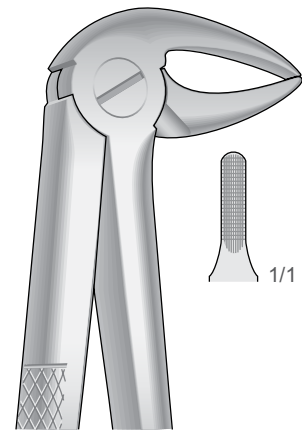

33A
Fig. 33A

Untere Wurzeln, schlankes Maul
Lower roots, Slender jaw
Radici inferiori, morso stretto
Raíces inferiores, boca estrecha
Racines inférieures, avec un bec très fin

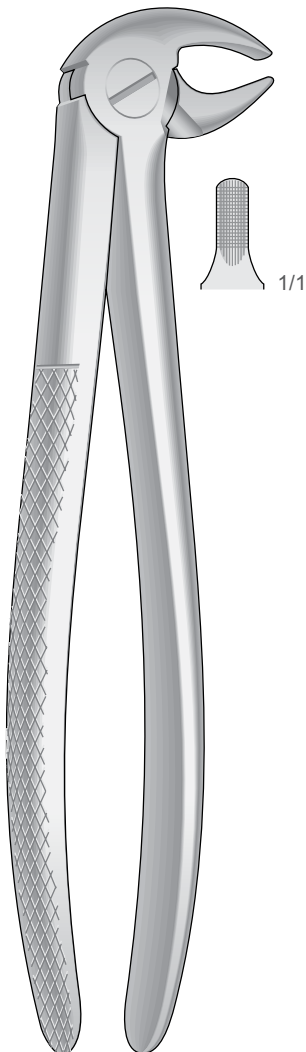

13

Fig. 13

Untere Eckzähne und Prämolaren
Lower cuspids and premolars
Canini e premolari inferiori
Caninos y premolares inferiores
Canines et prémolaires inférieures

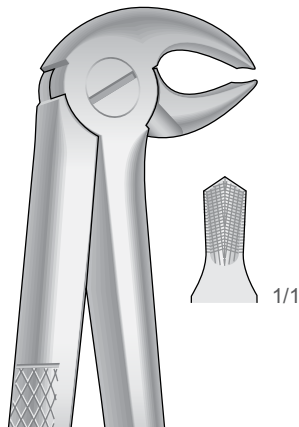

22
Fig. 22

Untere Molaren
Lower molars
Molari inferiori
Molares inferiores
Molaires inférieures

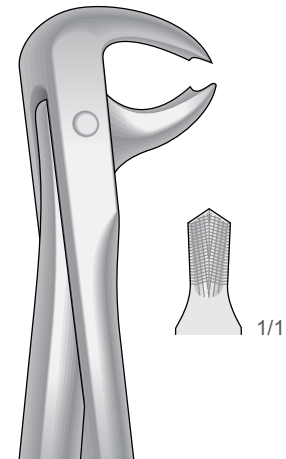

73
Fig. 73

Untere Molaren
Lower molars
Molari inferiori
Molares inferiores
Molaires inférieures

Extracting Forceps, English Pattern

Zahnzangen, Englische Form
Pinze per estrazione, Forma Inglese
Pinzas da extracción, Forma Inglesa
Daviers, Forme Anglaise

Forceps

Pinzette
Pinzas
Pinces
Pinzei

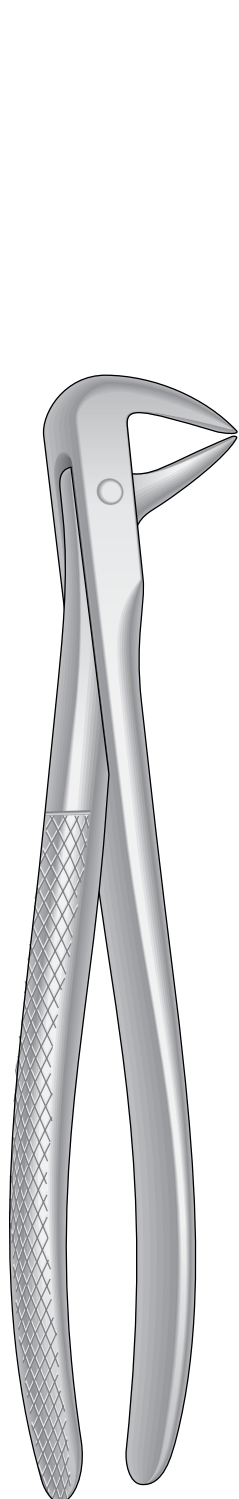

74
Fig. 74
Untere Wurzeln
Lower roots
Radici inferiori
Raíces inferiores
Racines inférieures

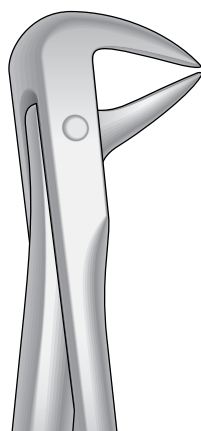
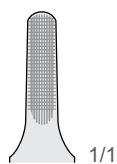

74N
Fig. 74N

Untere Wurzeln, schneide-und Eckzähne
Lower roots, Incisors and bicuspid
Radici, incisivi e canini inferiori
Raíces, incisivos y caninos inferiores
Racines, incisives et canines inférieures

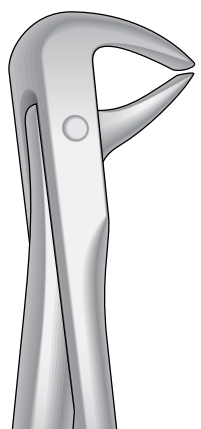
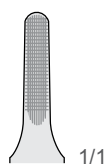

75
Fig. 75

Untere Eckzähne und Prämolaren
Lower Cuspids and bicuspid
Canini e premolari inferiori
Caninos y premolares inferiores
Canines et prémolaires inférieures

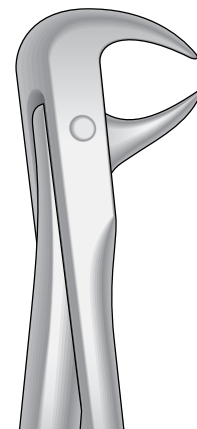
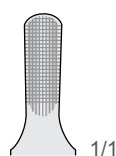

86A
Fig. 86A

Untere Molaren
Lower molars
Molari inferiori
Molares inferiores
Molaires inférieures

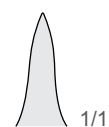

Extracting Forceps, English Pattern

Zahnzangen, Englische Form
 Pinze per estrazione, Forma Inglese
 Pinzas da extracción, Forma Inglesa
 Daviers, Forme Anglaise

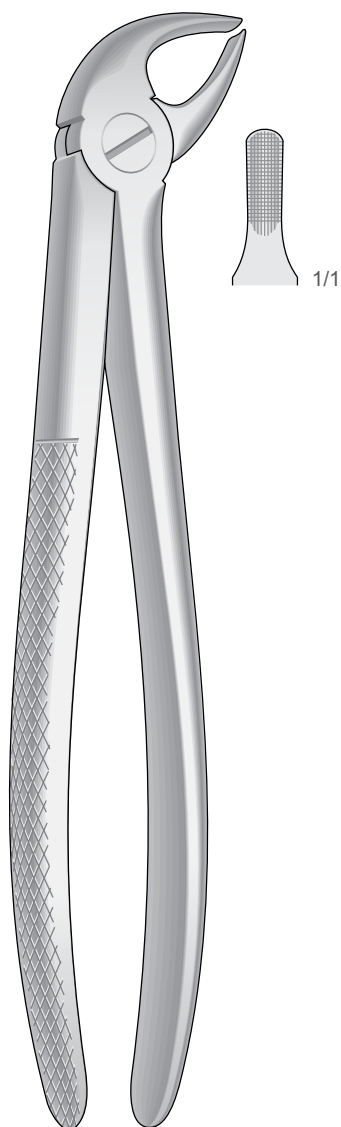

4

Fig. 4

Untere Schneide- und Eckzähne
 Lower Incisors and cuspids
 Incisivi e canini inferiori
 Incisivos y caninos inferiores
 Incisives et canines inférieures

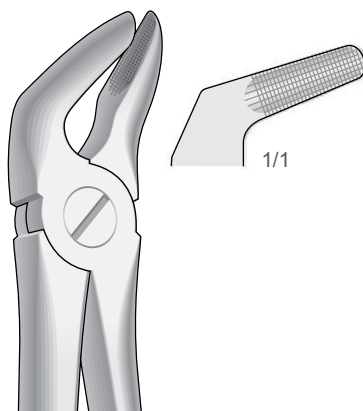

8

Fig. 8

Untere Prämolaren
 Lower premolars
 Premolari inferiori
 Premolares inferiores
 Prémolaires inférieures

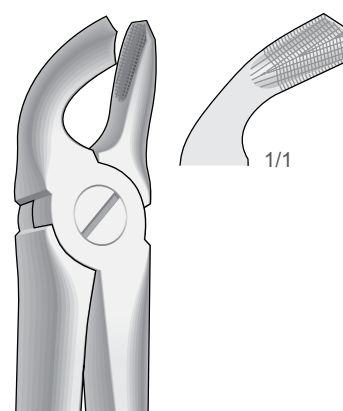

21

Fig. 21

Untere Weisheitszähne und Molaren
 Lower wisdom teeth and molars
 Denti del giudizio e molari inferiori
 Muelas del juicio y Molares inferiores
 Dents de sagesse et molaires inférieures

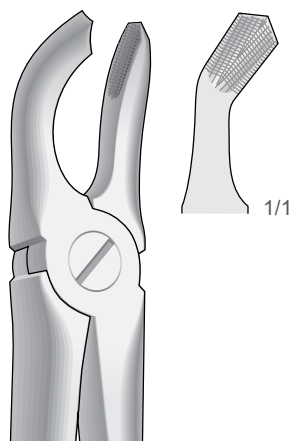

79

Fig. 79

Untere Weisheitszähne
 Lower wisdom teeth
 Denti del giudizio inferiori
 Muelas del juicio inferiores
 Dent de sagesse inférieures

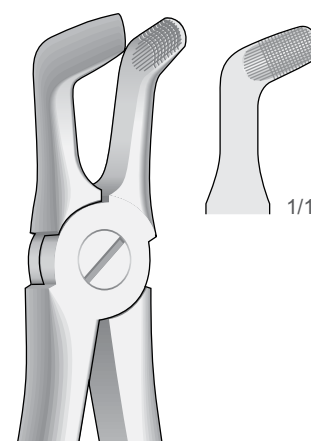

79A

Fig. 79A

Untere Molaren und Weisheitszähne
 Lower molars and wisdom teeth
 Molari e denti del giudizio inferiori
 Molares y muelas del juicio inferiores
 Molaires et dent de sagesse inférieures

Extracting Forceps, English Pattern

Zahnzangen, Englische Form
Pinze per estrazione, Forma Inglese
Pinzas da extracci6n, Forma Inglesa
Daviers, Forme Anglaise

Forceps

Pinzetten
Pinzas
Pinces
Pinzei

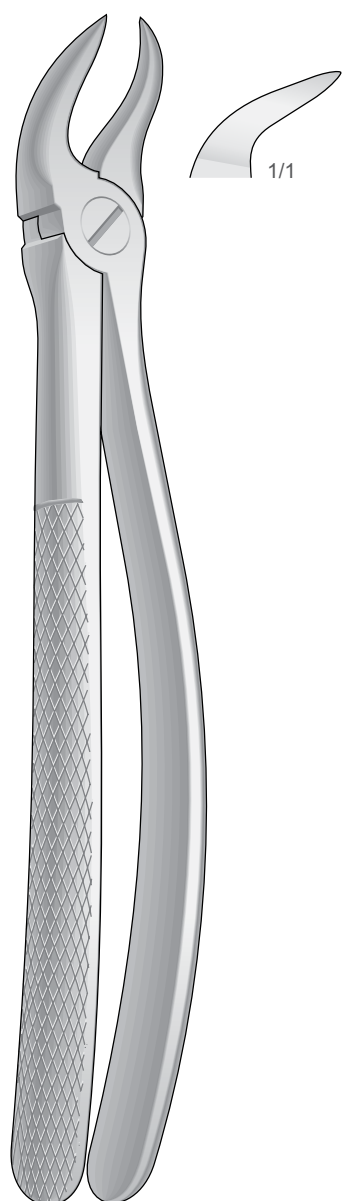

87
Fig. 87
Untere Molaren
Lower molars
Molari inferiori
Molares inferiores
Molaires inférieures

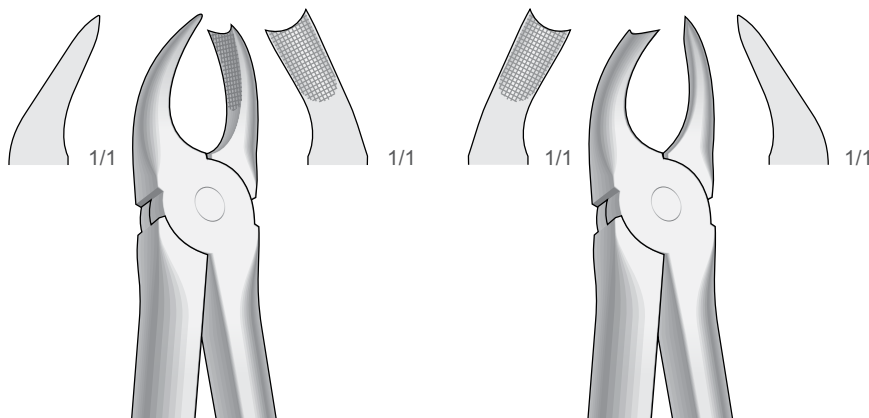

89
Fig. 89
Obere Molaren, rechts
Upper molars, right
Molari superiori, destra
Molares superiores, derechos
Molaires supérieures, droites

90
Fig. 90
Obere Molaren, links
Upper molars, left
Molari superiori, sinistra
Molares superiores, izquierdos
Molaires supérieures, gauches

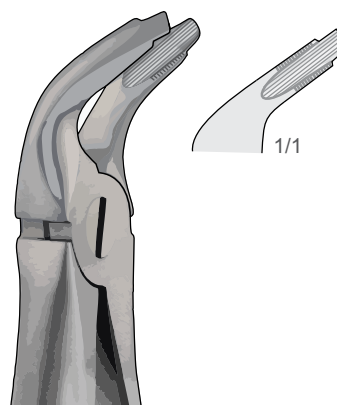

AM-451
Fig. 451
Deep Grip

Untere Wurzeln, schneide-und Eckzähne
Lower roots, incisors and bicuspid
Radici, incisivi e canini inferiori
Raíces, incisivos y caninos inferiores
Racines, incisives et canines inférieures

Extracting Forceps, English Pattern

Zahnzangen, Englische Form

Pinze per estrazione, Forma Inglese

Pinzas da extracci6n, Forma Inglesa

Daviers, Forme Anglaise

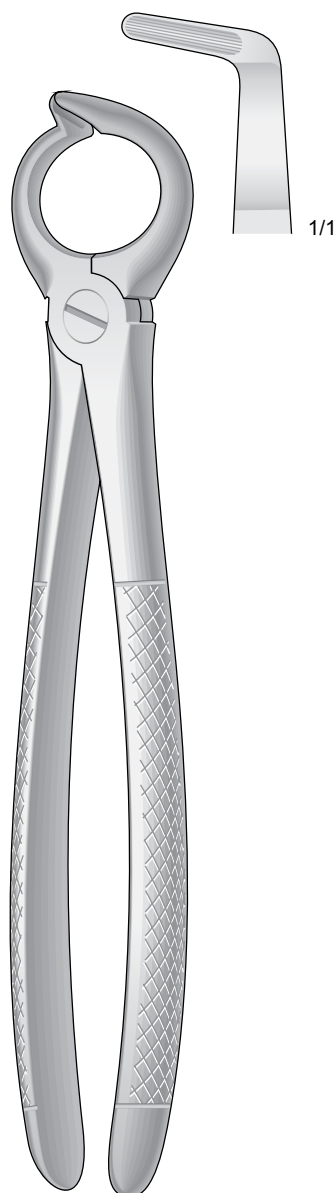

68

Fig. 68

Untere Wurzeln
Lower Roots
Radici inferiori
Raices inferiores
Racines inférieures

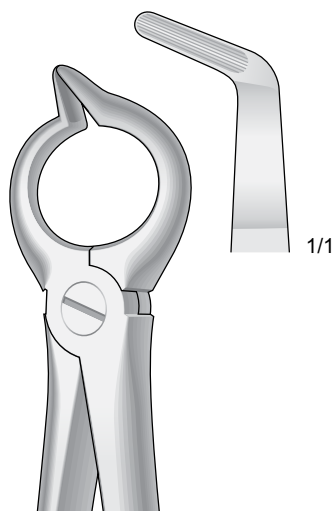

68A

Fig. 68A

Untere Wurzeln
Lower Roots
Radici inferiori
Raices inferiores
Racines inférieures

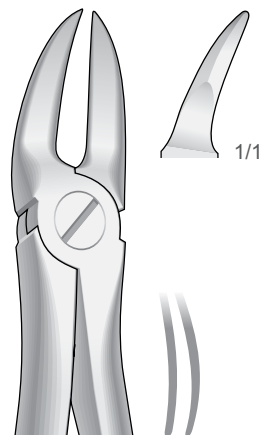

55

Fig. 55

Zum Trennen oberer Molarenwurzeln

For separating upper molar roots

Per radici dei molari superiori, presa in profondità

Para partir raices de molares superiores, profundo

Pour séparer les racines des molaires supérieures

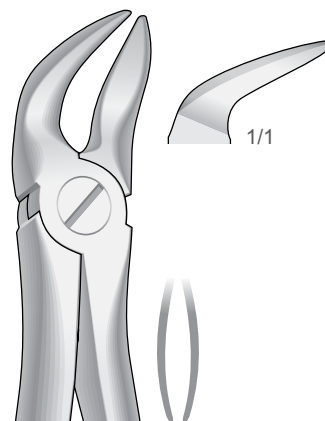

56

Fig. 56

Zum Trennen Unterer Molarenwurzeln

For separating lower molar roots

Per radici dei molari inferiori, presa in profondità

Para partir raices de molares inferiores, profundo

Pour séparer les racines des molaires inférieures

Extracting Forceps, English Pattern

Zahnzangen, Englische Form

Pinze per estrazione, Forma Inglese

Pinzas da extracci6n, Forma Inglesa

Daviers, Forme Anglaise

Forceps

Pinzette

Pinzas

Pinces

Pinzei

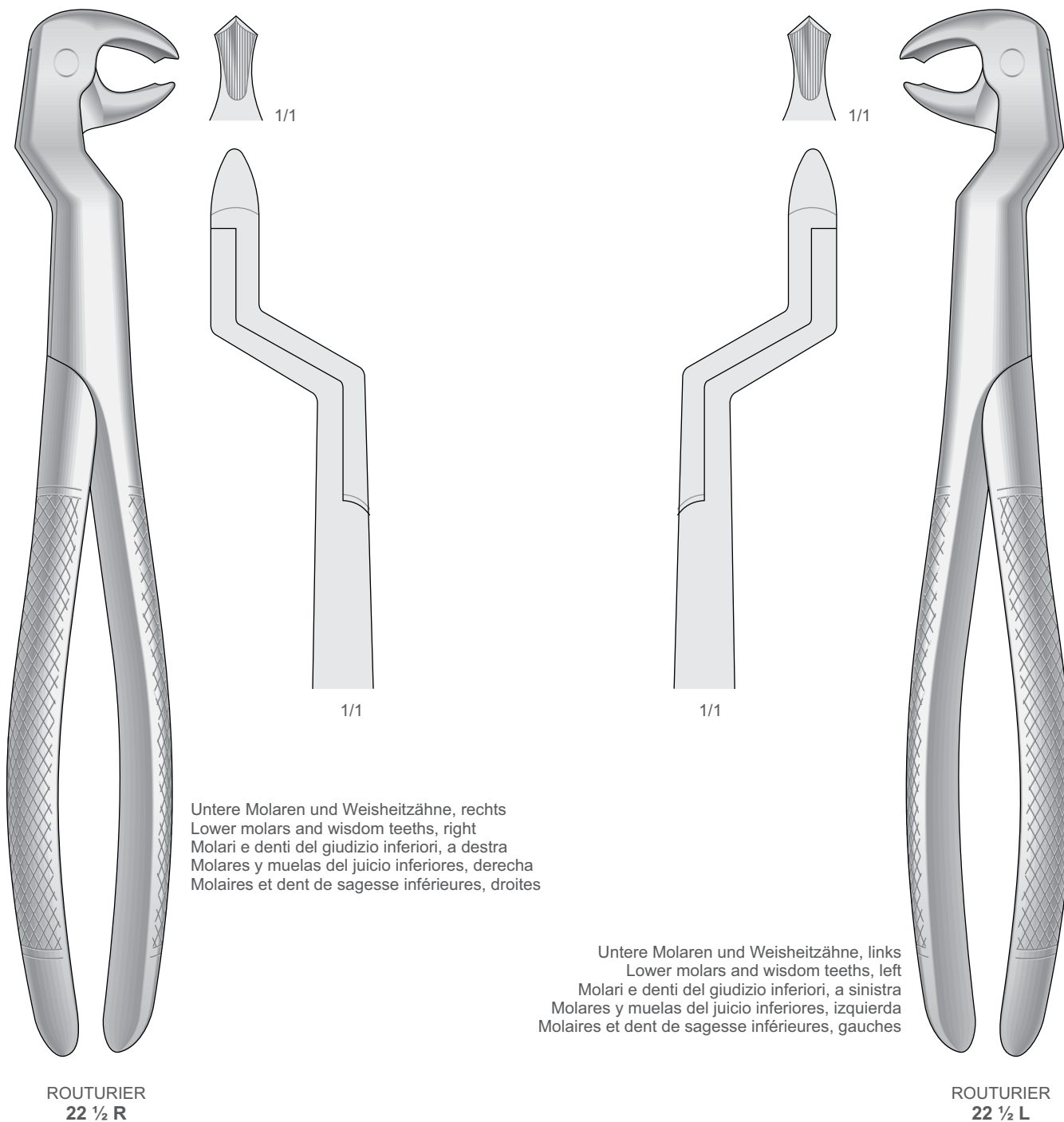

Extracting Forceps, English Pattern

Zahnzangen, Englische Form

Pinze per estrazione, Forma Inglese

Pinzas da extracci6n, Forma Inglesa

Daviers, Forme Anglaise

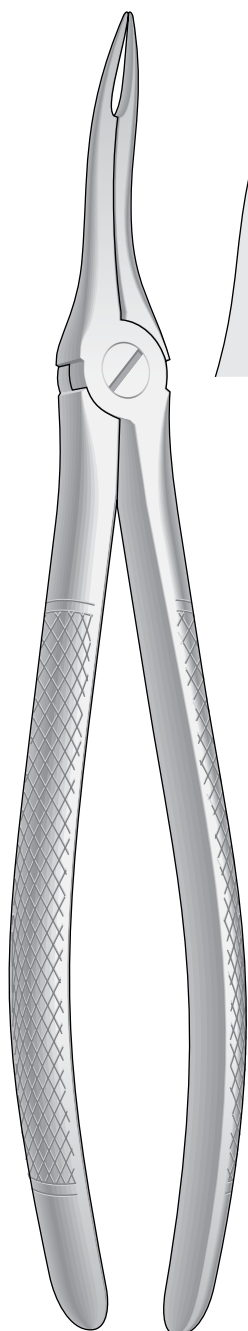

49
Fig. 49

Obere Wurzeln sehr feine
Upper very fine roots
Radici superiori molto sottili
Raíces superiores muy finas
Racines supérieures très fines

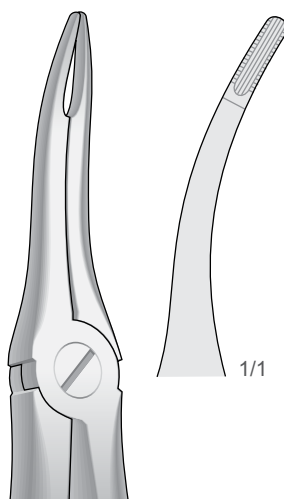

48
Fig. 48 - 44

Obere Wurzeln
Upper roots
Radici superiori
Raíces superiores
Racines supérieures

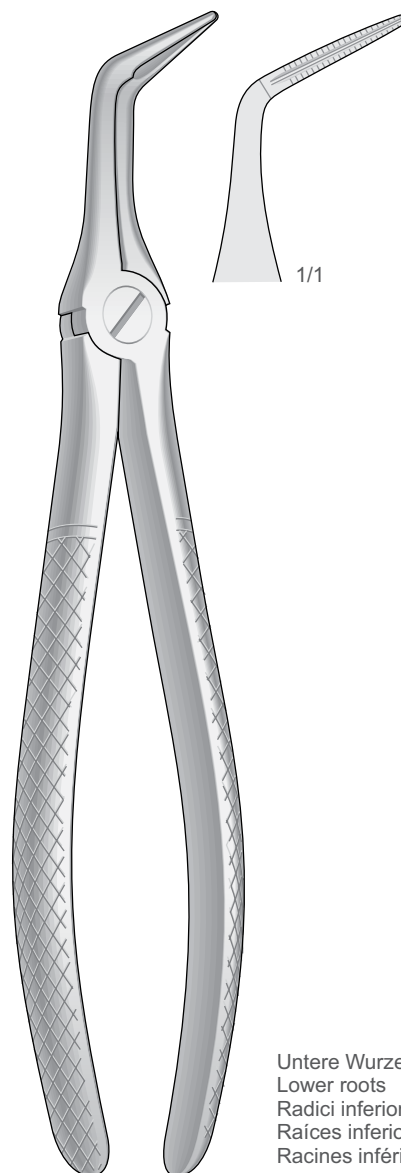

46L
Fig. 46L

Untere Wurzeln
Lower roots
Radici inferiori
Raíces inferiores
Racines inférieures

Extracting Forceps, Anatomical Handle

Zahnzangen, Paßformgriff
 Pinze per estrazione, Manico anatomico
 Pinzas da extracción, Mango anatómico
 Daviers, Manche anatomique

Forceps

Pinzette
 Pinzas
 Pincers
 Pinzei

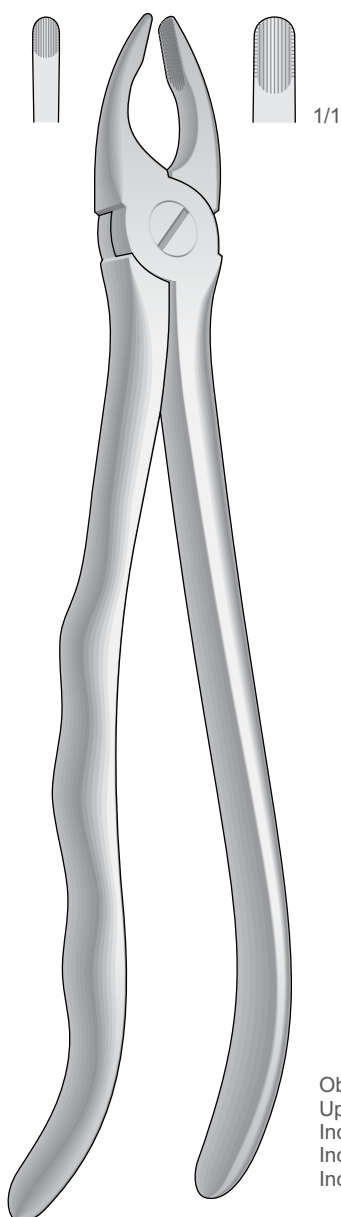

S-3AN
 Fig. 3

Obere Schneide- und Eckzähne
 Upper incisors and cuspids
 Incisivi e canini superiori
 Incisivos y caninos superiores
 Incisives et canines supérieures

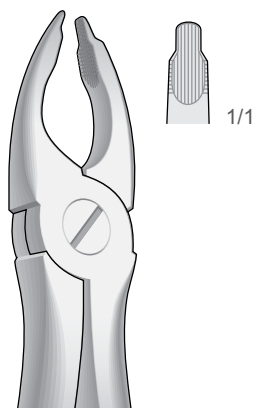

S-34
 Fig. 34

Obere Schneide- und Eckzähne
 Upper incisors and cuspids
 Incisivi e canini superiori
 Incisivos y caninos superiores
 Incisives et canines supérieures

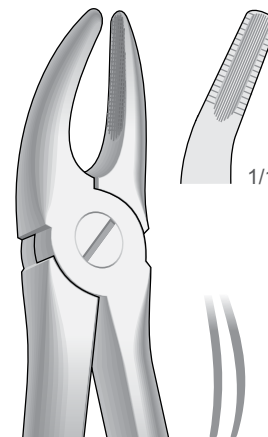

S-7
 Fig. 7

Obere Prämolaren
 Upper premolars
 Premolari superiori
 Premolares superiores
 Prémolaires supérieures

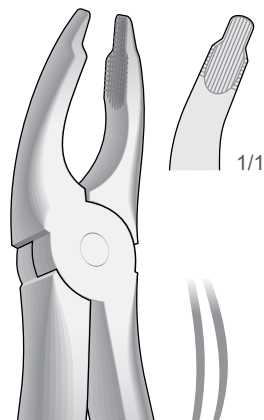

S-35
 Fig. 35

Obere Schneidezähne und Prämolaren, tiefgreifend
 Upper incisors and bicuspid, deep-gripping
 Incisivi e premolari superiori, presa in profondità
 Incisivos y premolares superiores, a gran calado
 Incisives et prémolaires supérieures, à attaque profonde

Extracting Forceps, Anatomical Handle

Zahnzangen, Paßformgriff

Pinze per estrazione, Manico anatomico

Pinzas da extracción, Mango anatómico

Daviers, Manche anatomique

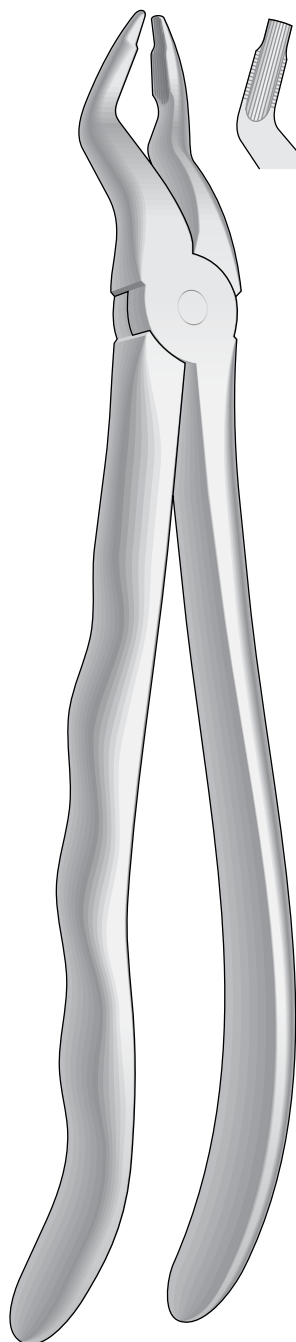

S-31
Fig. 31

Obere Prämolaren
Upper premolars
Premolari superiori
Premolares superiores
Prémolaires supérieures

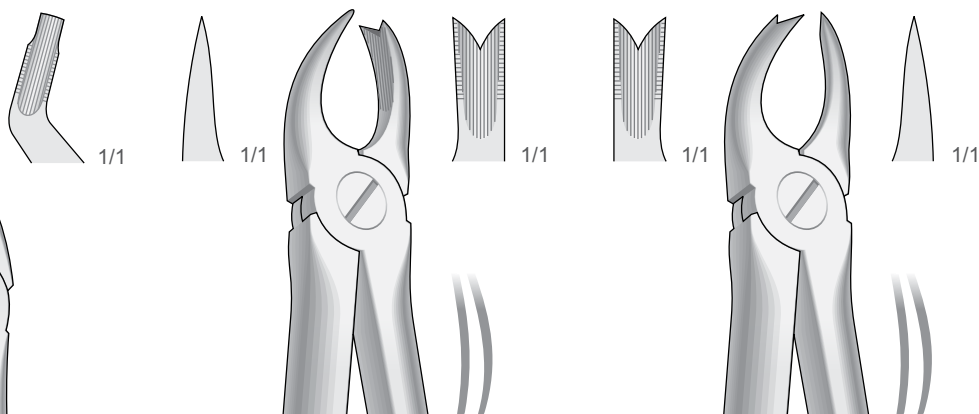

S-66R
Fig. 66R (89)

Obere Molaren, rechts
Upper molars, right
Molari superiori, destra
Molares superiores, derechos
Molaires supérieures, droites

S-66L
Fig. 66L (90)

Obere Molaren, links
Upper molars, left
Molari superiori, sinistra
Molares superiores, izquierdos
Molaires supérieures, gauches

Extracting Forceps, Anatomical Handle

Zahnzangen, Paßformgriff

Pinze per estrazione, Manico anatomico

Pinzas da extracción, Mango anatómico

Daviers, Manche anatomique

Forceps

Pinzetten

Pinzas

Pinces

Pinzei

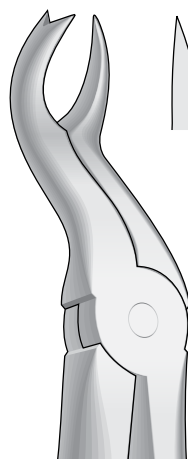
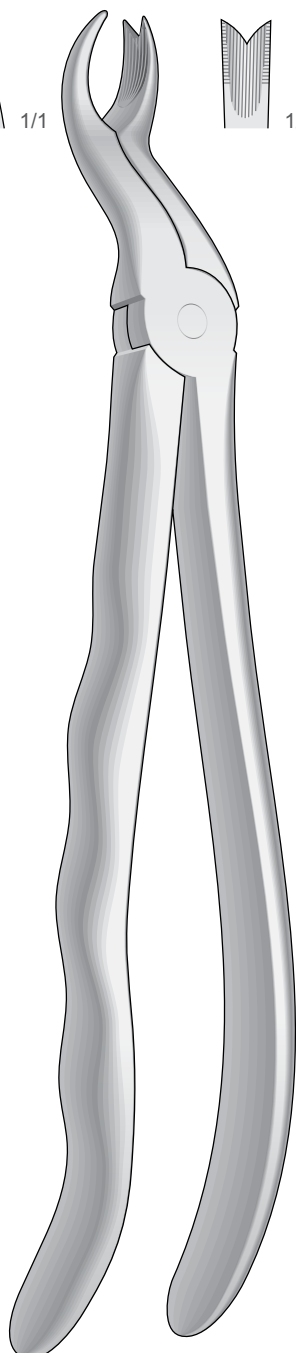
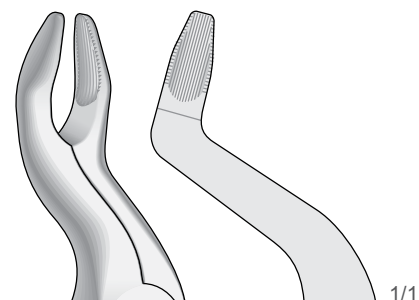

S-67L
Fig. 67L

Obere Molaren, links
Upper molars, left
Molari superiori, sinistra
Molares superiores, izquierdos
Molaires supérieures, gauches

S-67N
Fig. 67N

Obere Molaren
Upper molars
Molari superiori
Molares superiores
Molaires supérieures

Obere Molaren, rechts
Upper molars, right
Molari superiori, destra
Molares superiores, derechos
Molaires supérieures, droites

S-67R
Fig. 67R

Extracting Forceps, Anatomical Handle

Zahnzangen, Paßformgriff

Pinze per estrazione, Manico anatomico

Pinzas da extracción, Mango anatómico

Daviers, Manche anatomique

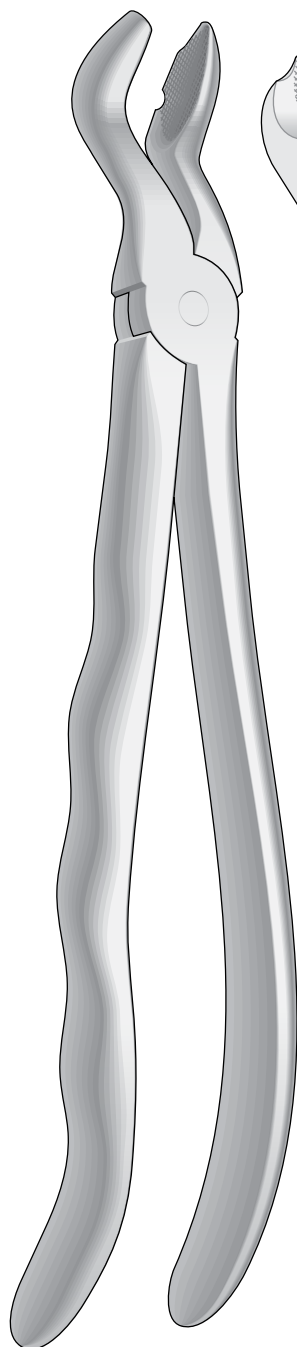

FELSCH
S-80
Fig. 80

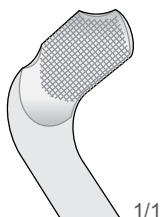

1/1

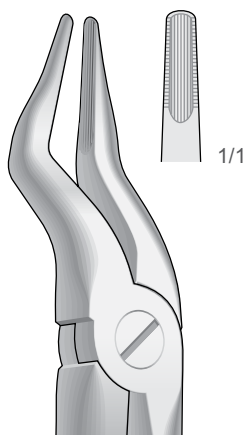

1/1

S-51B
Fig. 51B

Obere Dritte Molaren
Upper molars
Ottavi superiori
Molares superiores
Molaires supérieures

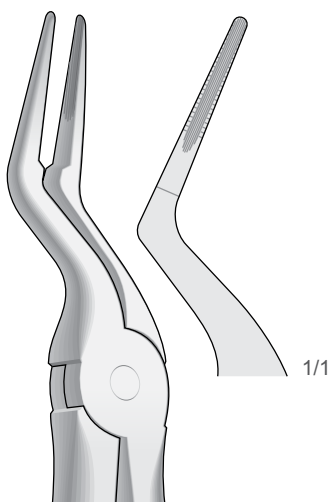

1/1

S-97
Fig. 97

Obere Wurzelplitterzange
Upper Root Fragments
Frammenti e radici superiori
Fragmentos de raíces superiores
Fragments des racines supérieures

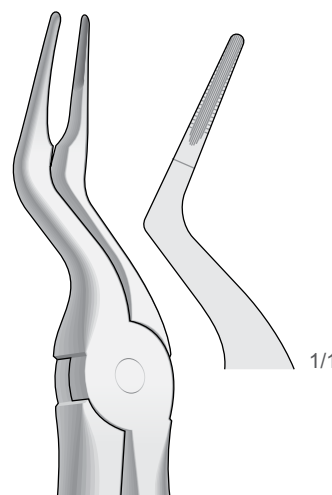

1/1

S-97B
Fig. 97B

Obere Wurzelplitterzange
Upper Root Fragments
Frammenti e radici superiori
Fragmentos de raíces superiores
Fragments des racines supérieures

Für obere Weisheitszähne, mit Fangvorrichtung
For upper wisdom teeth, with retaining device
Denti del giudizio superiori, con dispositivo di presa
Muelas del juicio superiores, con dispositivo de retencion
Pour dents de sagesse supérieures, mors conçus pour recueillir la dent

Extracting Forceps, Anatomical Handle

Zahnzangen, Paßformgriff

Pinze per estrazione, Manico anatomico

Pinzas da extracción, Mango anatómico

Daviers, Manche anatomique

Forceps

Pinzette

Pinzas

Pinces

Pinzei

Obere Wurzeln sehr feine
Upper very fine roots
Radici superiori molto sottili
Raíces superiores muy finas
Racines supérieures très fines

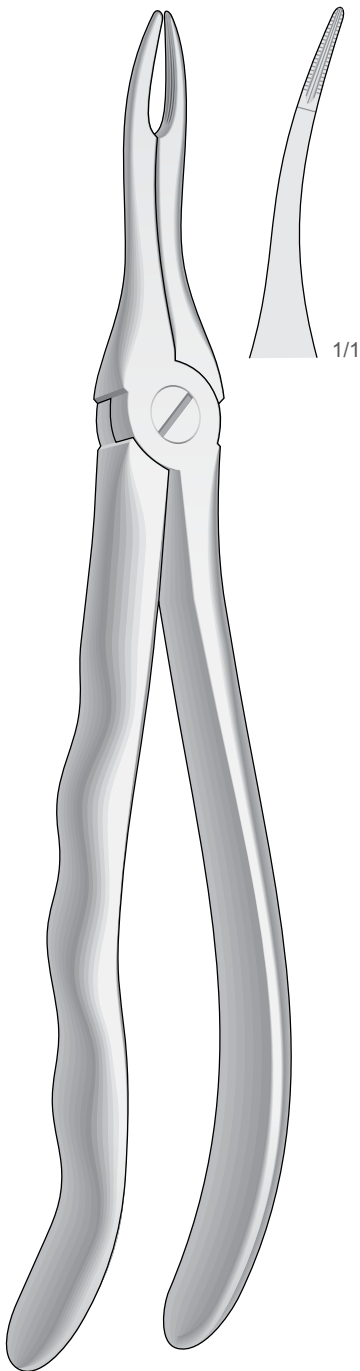

S-49
Fig. 49

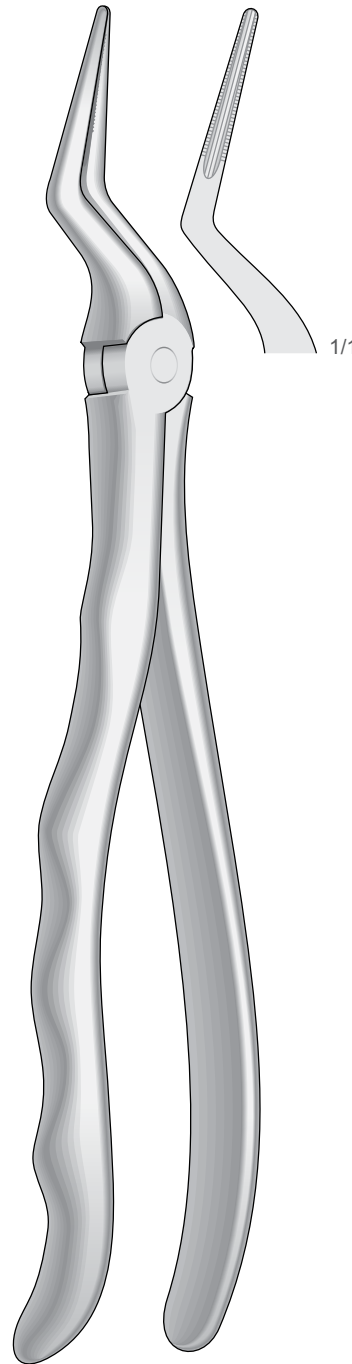

S-51LX
Fig. 51LX

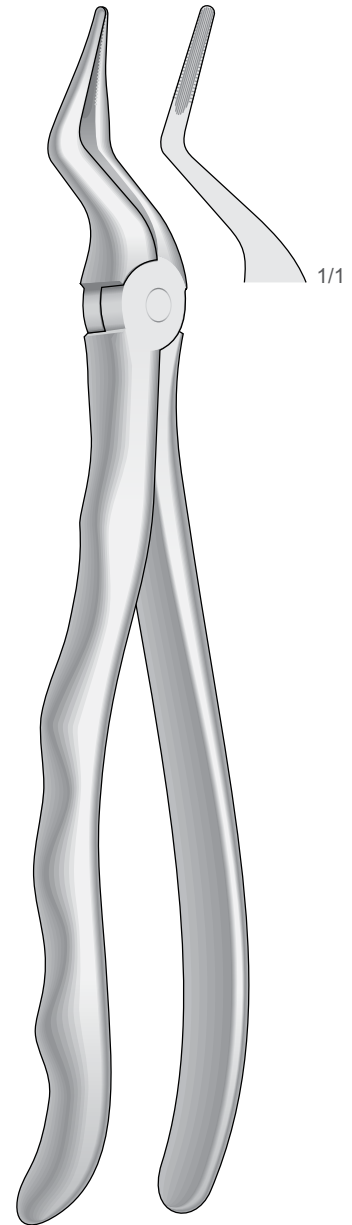

S-351S
Fig. 351S

Extracting Forceps, Anatomical Handle

Zahnzangen, Paßformgriff

Pinze per estrazione, Manico anatomico

Pinzas da extracción, Mango anatómico

Daviers, Manche anatomique

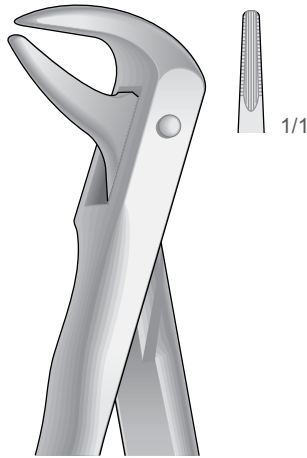

I-74N
Fig. 74N

Untere Wurzeln Schneide- und Eckzähne
Lower roots, incisors and cuspids
Radici, incisivi e canini inferiori
Raíces, incisivos y caninos inferiores
Racines, incisives et canines inférieures

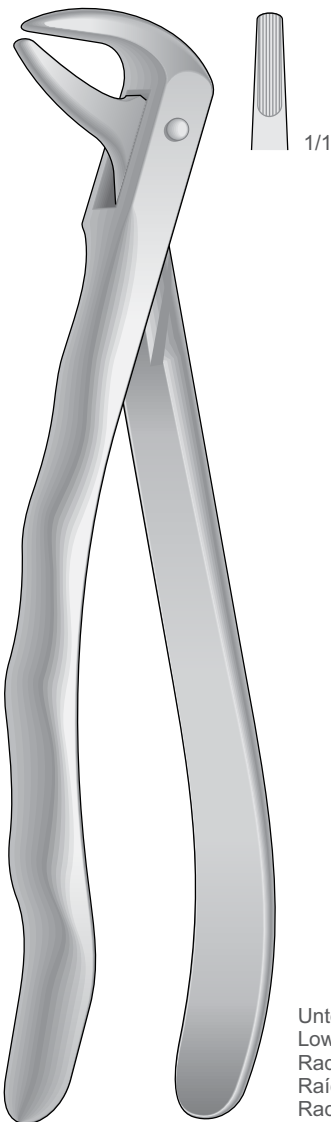

I-74
Fig. 74

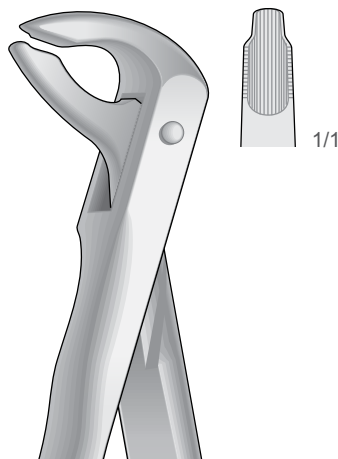

I-36
Fig. 36

Untere Wurzeln Schneide- und Eckzähne
Lower roots, incisors and cuspids
Radici, incisivi e canini inferiori
Raíces, incisivos y caninos inferiores
Racines, incisives et canines inférieures

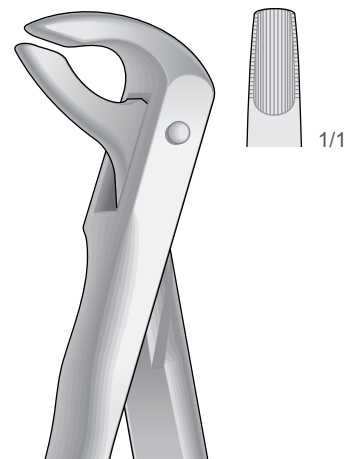

I-36N
Fig. 36N

Untere Wurzeln Schneide- und Eckzähne
Lower roots, incisors and cuspids
Radici, incisivi e canini inferiori
Raíces, incisivos y caninos inferiores
Racines, incisives et canines inférieures

Extracting Forceps, Anatomical Handle

Zahnzangen, Paßformgriff
 Pinze per estrazione, Manico anatomico
 Pinzas da extracción, Mango anatómico
 Daviers, Manche anatomique

Forceps

Pinzette
 Pinzas
 Pincers
 Pinzei

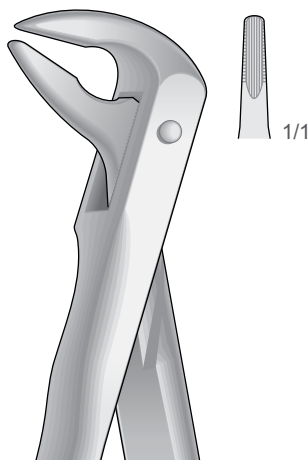

I-59
 Fig. 59

Untere Wurzelplitterzange
 Lower Root Fragments
 Frammenti e radici inferiori
 Fragmentos de raíces inferiores
 Fragments des racines inférieures

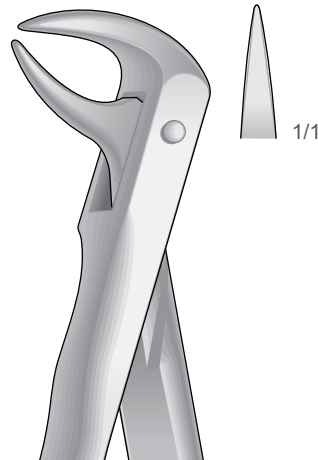

I-86C
 Fig. 86C

Untere Molaren mit kariesen oder abgebrochenen Kronen
 Lower molars with carious or broken caps
 Molari inferiori con corone cariate o spezzate
 Molares inferiores con coronas rotas o cariadas
 Molaires inférieures avec couronnes cariées ou cassées

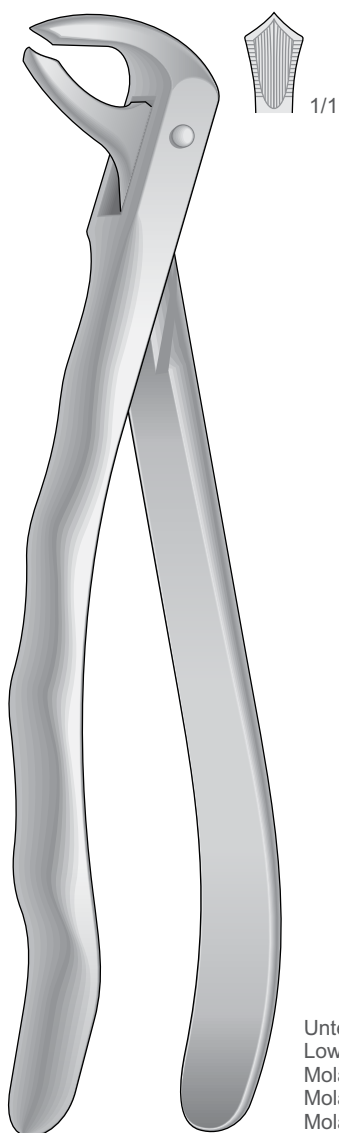

I-73
 Fig. 73

Untere Molaren
 Lower molars
 Molari inferiori
 Molares inferiores
 Molaires inférieures

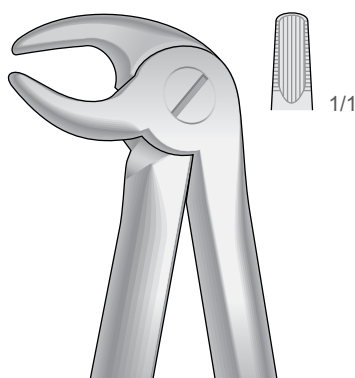

I-13
 Fig. 13

Untere Prämolaren und Eckzähne
 Lower premolars and cuspids
 Canini e premolari inferiori
 Caninos y premolares inferiores
 Canines et prémolaires inférieures



I-22
 Fig. 22

Untere Molaren
 Lower molars
 Molari inferiori
 Molares inferiores
 Molaires inférieures

Extracting Forceps, Anatomical Handle

Zahnzangen, Paßformgriff

Pinze per estrazione, Manico anatomico

Pinzas da extracción, Mango anatómico

Daviers, Manche anatomique

Untere Weisheitszähne
Lower wisdom teeth
Denti del giudizio inferiori
Muelas del juicio inferiores
Dent de sagesse inférieures

Untere Prämolaren
Lower premolars
Premolari inferiori
Premolares inferiores
Prémolaires inférieures

Untere Molaren
Lower Molars
Molari inferiori
Molares inferiores
Molaires inférieures

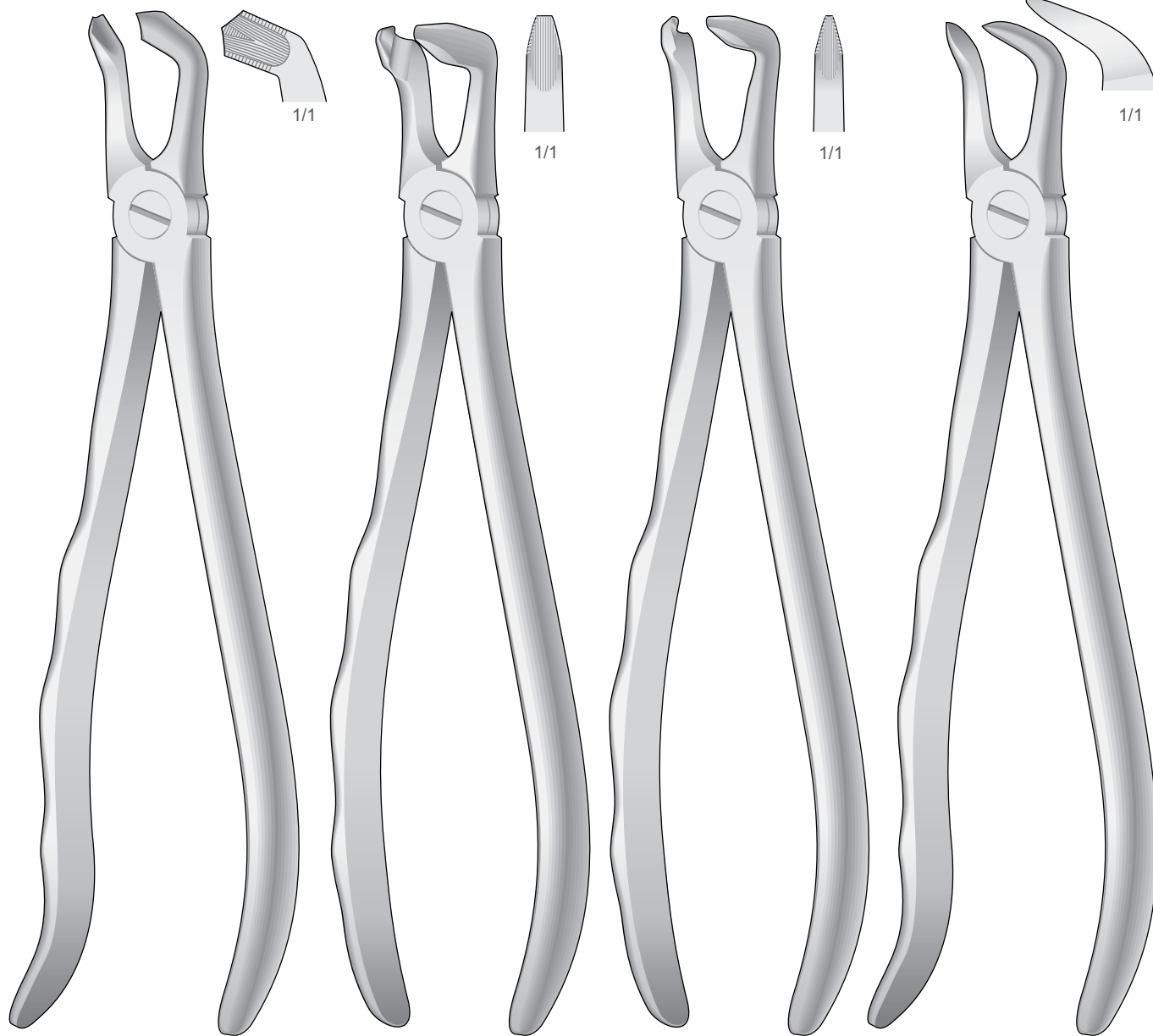

I-79
Fig. 79

I-79N
Fig. 79N

I-46N
Fig. 46N

I-87
Fig. 87

Extracting Forceps, Anatomical Handle

Zahnzangen, Paßformgriff

Pinze per estrazione, Manico anatomico

Pinzas da extracción, Mango anatómico

Daviers, Manche anatomique

Forceps

Pinzetten

Pinzas

Pinces

Pinzei

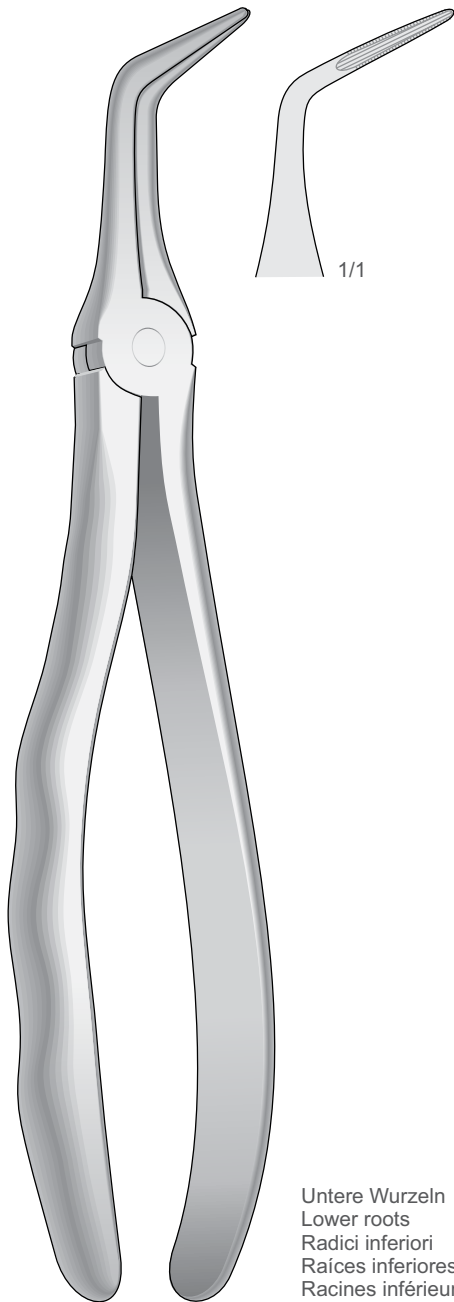

I-46LX
Fig. 46LX

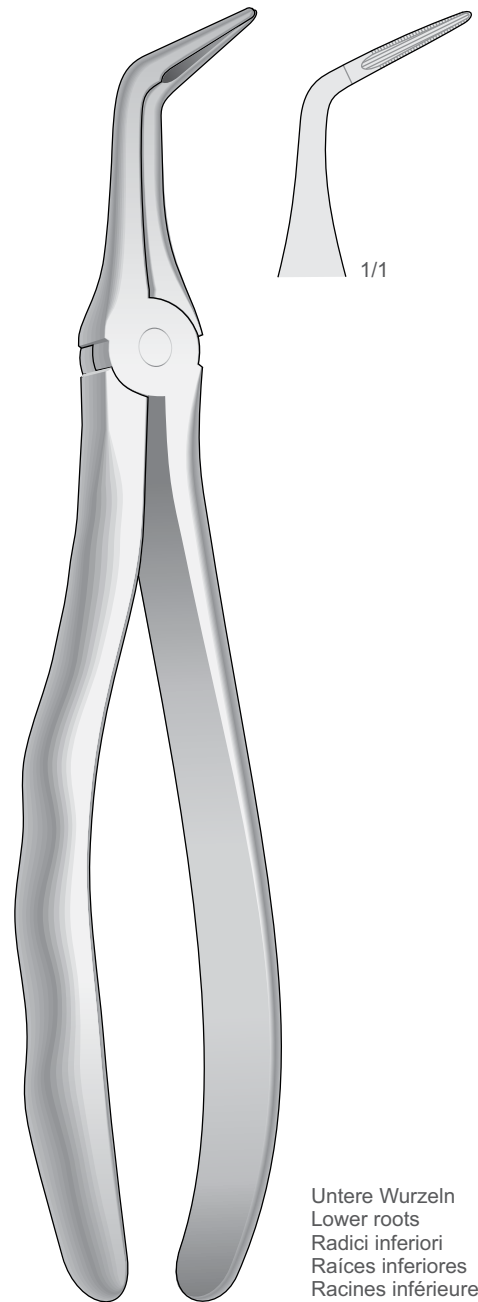

I-46L
Fig. 46L

Extracting Forceps, Anatomical Handle

Zahnzangen, Paßformgriff

Pinze per estrazione, Manico anatomico

Pinzas da extracción, Mango anatómico

Daviers, Manche anatomique

Untere Molaren und Weisheitszähne
Lower molars and wisdom teeth
Molari e denti del giudizio inferiori
Molares y muelas del juicio inferiores
Molaires et dent de sagesse inférieures

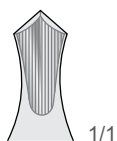
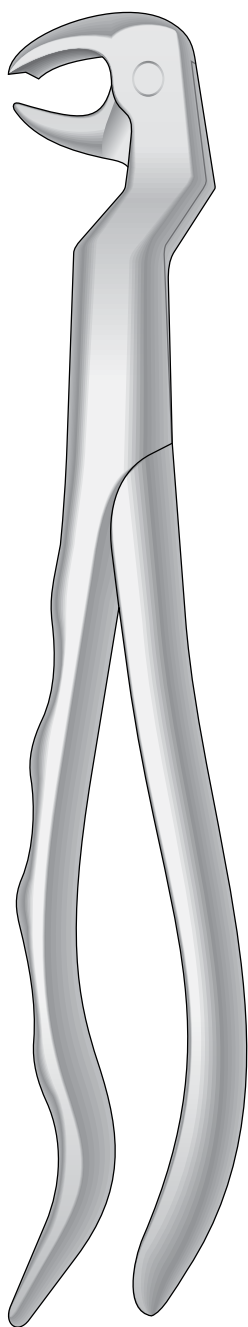

Links
Left
Sinistra
Izquierdos
Gauches

I-22 1/2 L

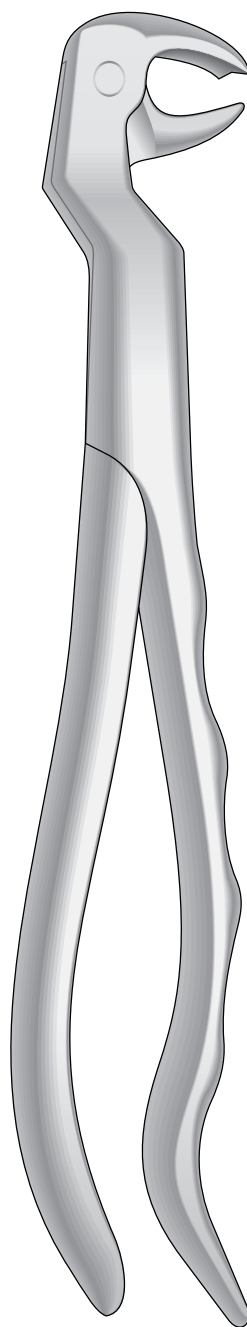

Rechts
Right
Destra
Derechos
Droites

I-22 1/2 R

Extracting Forceps, Anatomical Handle

Zahnzangen, Paßformgriff

Pinze per estrazione, Manico anatomico

Pinzas da extracción, Mango anatómico

Daviers, Manche anatomique

Forceps

Pinzetten

Pinzas

Pinces

Pinzei

Untere Wurzeln sehr feine
Lower very fine roots
Radici inferiori molto sottili
Raíces inferiores muy finas
Racines inférieures très fines

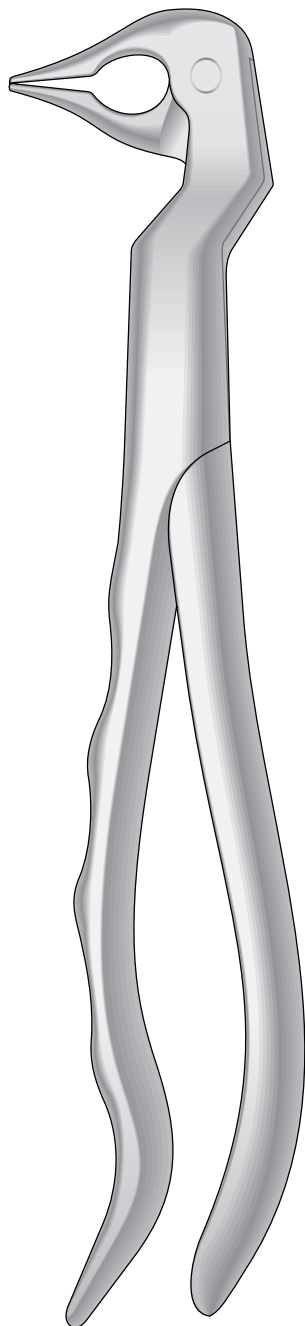

I-133 L
Fig.133

Links
Left
Sinistra
Izquierdos
Gauches

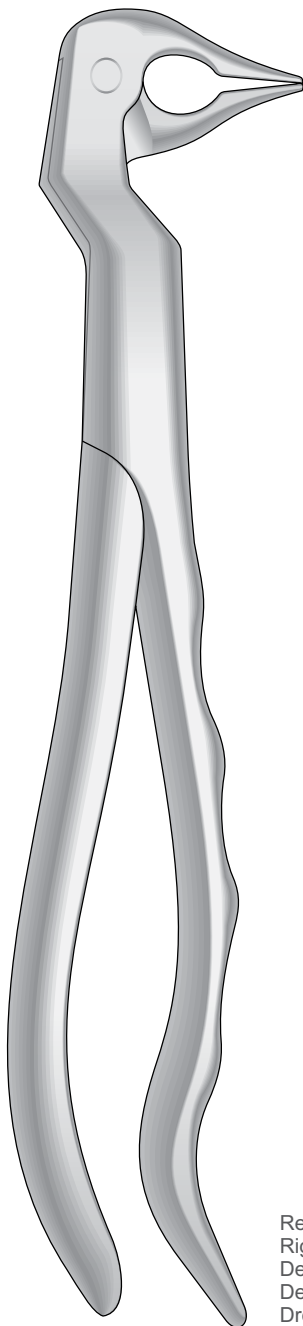

I-133 R
Fig.133

Rechts
Right
Dextra
Derechos
Droites

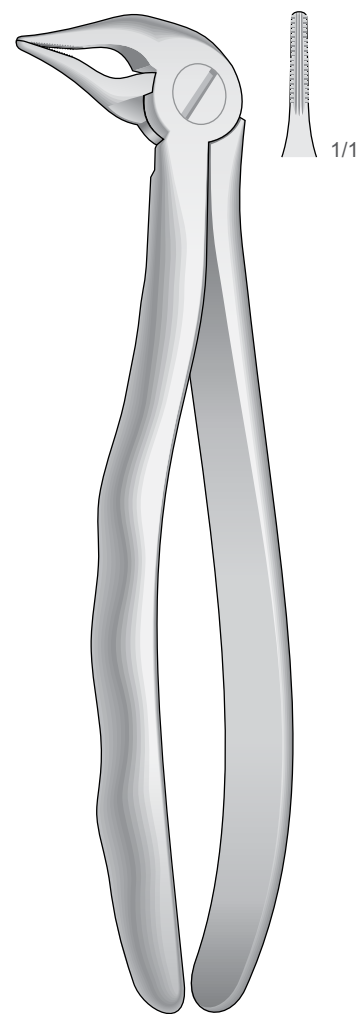

I-333S
Fig.333S

Extracting Forceps, American Pattern

Zahnzangen, Amerikanische Form
Pinze per estrazione, Forma Americana
Pinzas da extracción, Forma Americana
Daviers, Forme Américaine

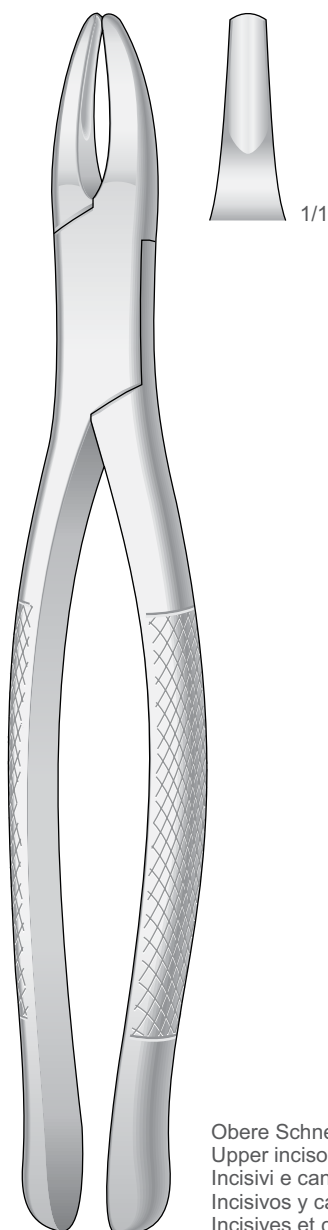

Obere Schneide- und Eckzähne
Upper incisors and cuspids
Incisivi e canini superiori
Incisivos y caninos superiores
Incisives et canines supérieures

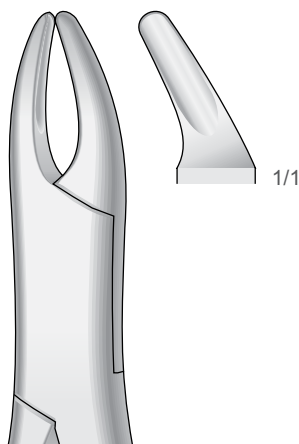

Obere Prämolaren, Schneidezähne, Wurzeln
Upper Bicuspid, incisors and roots
Premolari, incisivi e radici superiori
Premolares, incisivos y raíces superiores
Prémolaires, incisives et racines supérieures

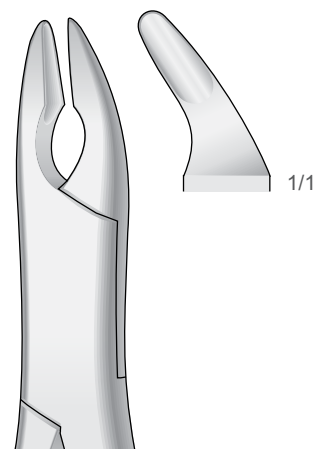

Obere Prämolaren, Schneidezähne, Wurzeln
Upper Bicuspid, incisors and roots
Premolari, incisivi e radici superiori
Premolares, incisivos y raíces superiores
Prémolaires, incisives et racines supérieures

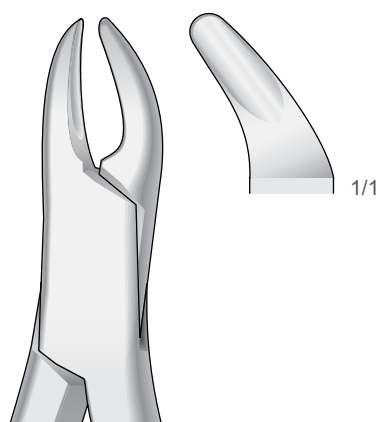

Schneidezähne, Prämolaren, Milchzähne
Incisors, premolars, deciduous teeth
Incisivi, premolari, denti da latte
Incisivos, premolares, dientes de leche
Incisives, prémolaires, dents de lait

Extracting Forceps, American Pattern

Zahnzangen, Amerikanische Form
 Pinze per estrazione, Forma Americana
 Pinzas da extracción, Forma Americana
 Daviers, Forme Américaine

Forceps

Pinzetten
 Pinzas
 Pincés
 Pinzei

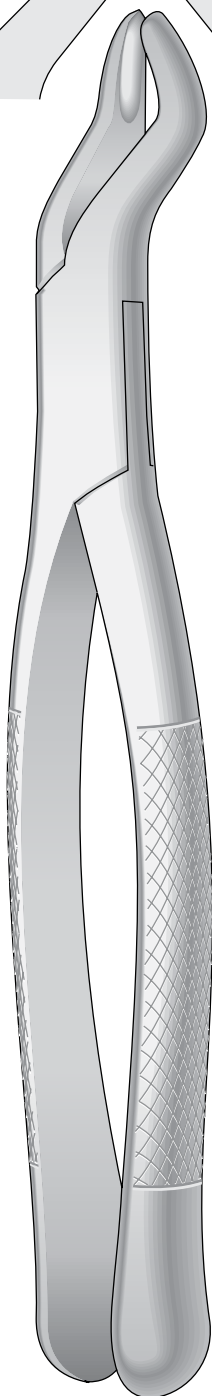
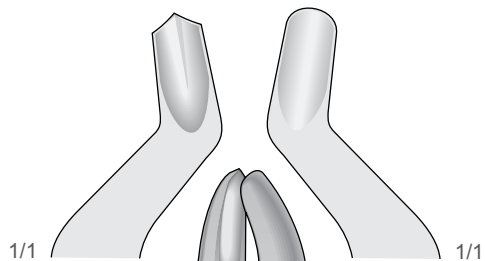

AM-53R
 Fig. 53R

Obere Molaren, Rechts
 Upper Molars, Right
 Molari superiori, Destra
 Molares superiores, Derechos
 Molaires supérieures, Droites

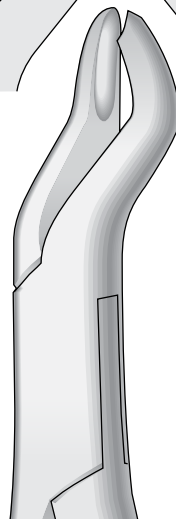
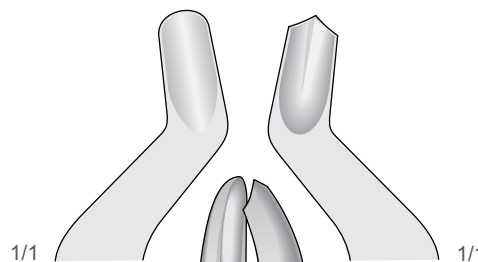

AM-53L
 Fig. 53L

Obere Molaren, Links
 Upper Molars, Left
 Molari superiori, Sinistra
 Molares superiores, Izquierdos
 Molaires supérieures, Gauches

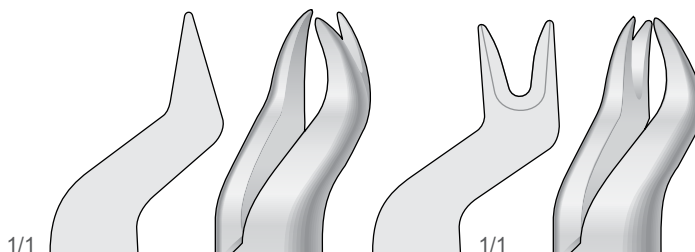

NEVIUS
AM-88R
 Fig. 88R

Obere Molaren, Rechts
 Upper Molars, Right
 Molari superiori, Destra
 Molares superiores, Derechos
 Molaires supérieures, Droites

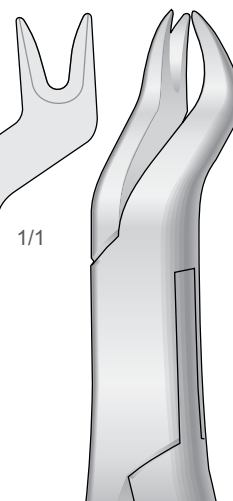

NEVIUS
AM-88L
 Fig. 88L

Obere Molaren, Links
 Upper Molars, Left
 Molari superiori, Sinistra
 Molares superiores, Izquierdos
 Molaires supérieures, Gauches

Extracting Forceps, American Pattern

Zahnzangen, Amerikanische Form
Pinze per estrazione, Forma Americana
Pinzas da extracción, Forma Americana
Daviers, Forme Américaine

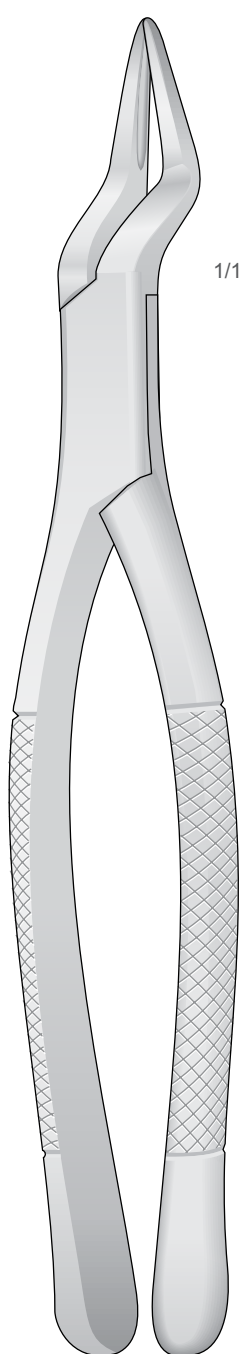

AM-65
Fig.65

Obere Schneidezähne und Wurzeln
Upper Incisors and Roots
Incisivi e radici superiori
Incisivos y raíces superiores
Incisives et racines supérieures

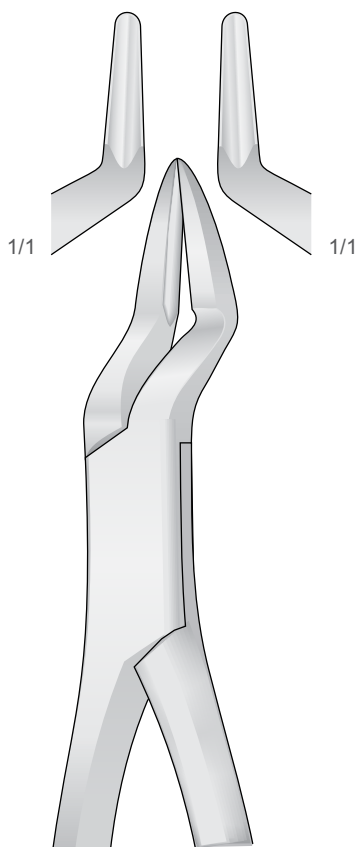

PARMLY
AM-32A
Fig. 32A

Obere Wurzeln und Prämolaren
Upper Roots and Premolars
Radici e premolari superiori
Raíces y premolares superiores
Racines et prémolaires supérieures

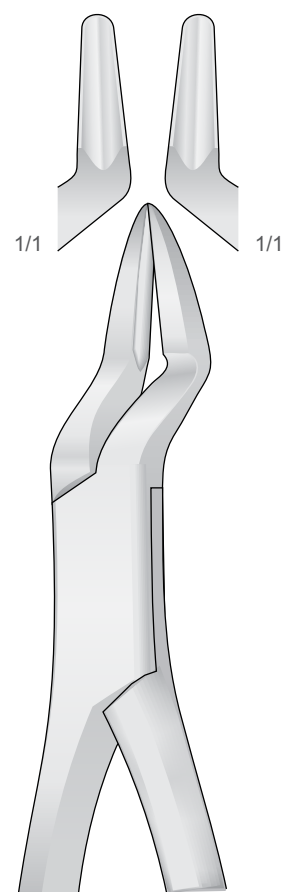

PARMLY
AM-32
Fig. 32

Obere Prämolaren und Molaren
Upper Premolars and Molars
Premolari e molari superiori
Premolares y Molares superiores
Prémolaires et Molaires supérieures

Extracting Forceps, American Pattern

Zahnzangen, Amerikanische Form
Pinze per estrazione, Forma Americana
Pinzas da extracción, Forma Americana
Daviers, Forme Américaine

Forceps

Pinzetten
Pinzas
Pinces
Pinzei

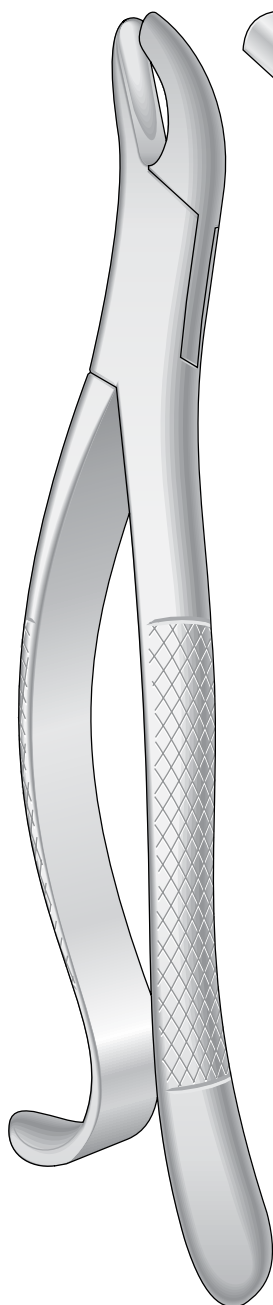

AM-24
Fig. 24

Obere Molaren
Upper Molars
Molari superiori
Molares superiores
Molaires supérieures

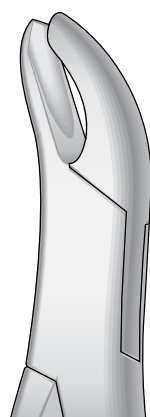
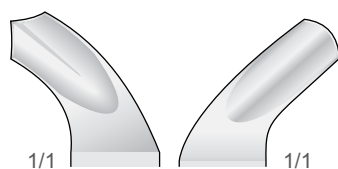

HARRIS
AM-18R
Fig. 18R

Obere Molaren, Rechts
Upper Molars, Right
Molari superiori, Destra
Molares superiores, Derechos
Molaires supérieures, Droites



HARRIS
AM-18L
Fig. 18L

Obere Molaren, Links
Upper Molars, Left
Molari superiori, Sinistra
Molares superiores, Isquierdos
Molaires supérieures, Gauches

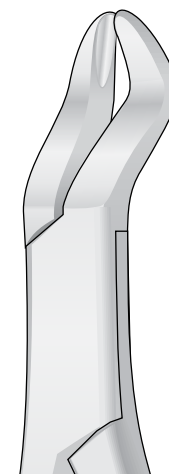
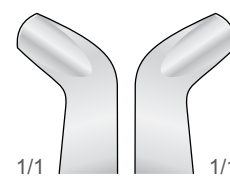

AM-210
Fig. 210

Obere Molaren
Upper Molars
Molari superiori
Molares superiores
Molaires supérieures

Extracting Forceps, American Pattern

Zahnzangen, Amerikanische Form
 Pinze per estrazione, Forma Americana
 Pinzas da extracción, Forma Americana
 Daviers, Forme Américaine

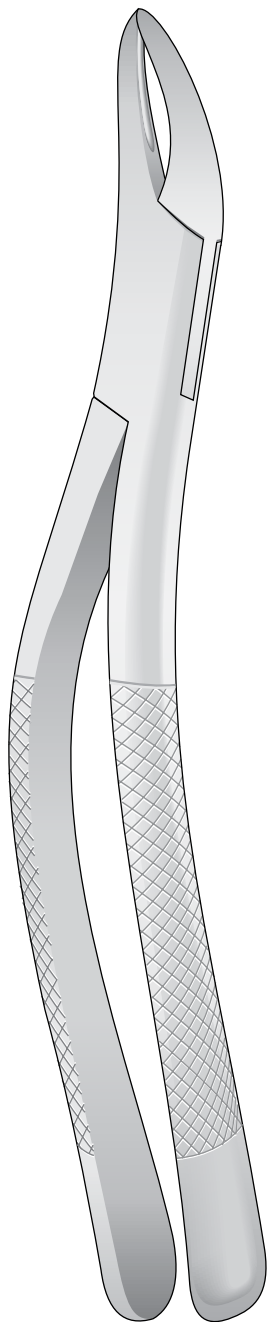
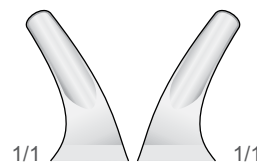
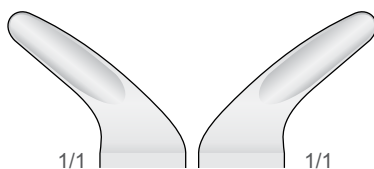
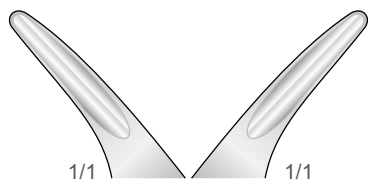

TAMES
AM-69
 Fig.69

Obere und Untere
 Upper and lower
 Superiori e inferiori
 Superiores y inferiores
 Supérieures et inférieures

Wurzeln
 Roots
 Radici
 Raíces
 Racines

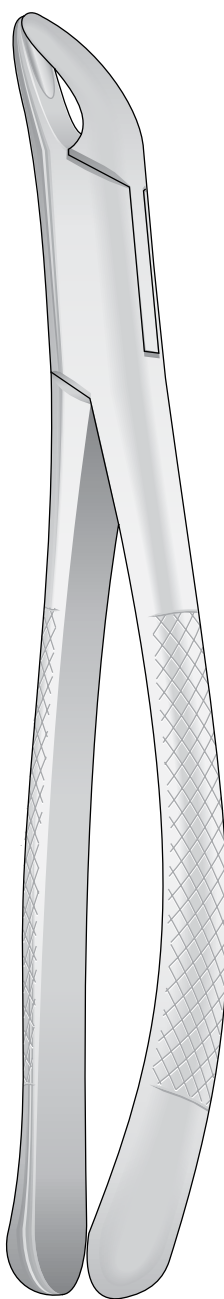

CRYER
AM-151
 Fig.151

Untere
 Lower
 Inferiori
 Inferiores
 Inférieures

Schneidezähne, Prämolaren, Wurzeln
 Incisors, Premolars, Roots
 Incisivi, premolari, radici
 Incisivos, premolares, raíces
 Incisives, prémolaires, racines

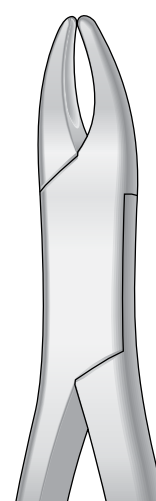

HULL
AM-101
 Fig. 101

Für Eckzähne und Prämolaren,
 Universalzange und Kinderzange
 For canines and Premolars,
 Universal and Tooth forceps for children
 Canini e premolari,
 universale e per bambini
 Caninos y premolares,
 universal y para niños
 Canines et prémolaires,
 universel et pour enfants

Extracting Forceps, American Pattern

Zahnzangen, Amerikanische Form
 Pinze per estrazione, Forma Americana
 Pinzas da extracción, Forma Americana
 Daviers, Forme Américaine

Forceps

Pinzetten
 Pinzas
 Pincés
 Pinzei

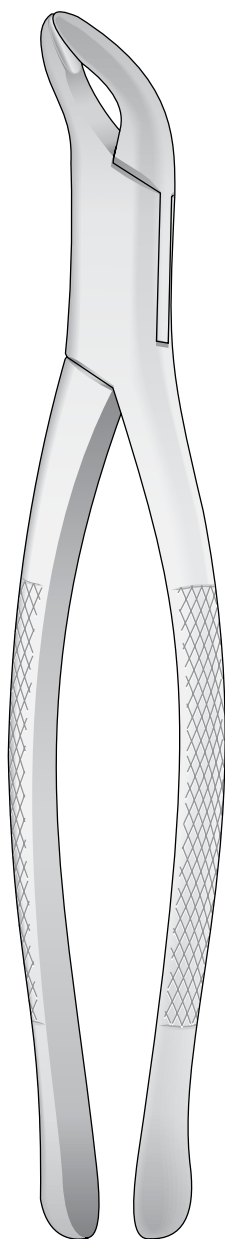
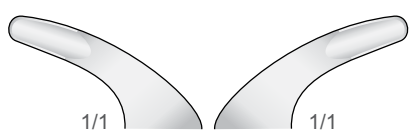

AM-203
 Fig. 203

Untere Schneidezähne, Prämolaren, Wurzeln
 Lower Incisors, Premolars, Roots
 Incisivi, premolari, radici inferiori
 Incisivos, premolares, raíces inferiores
 Incisives, prémolaires, racines inférieures

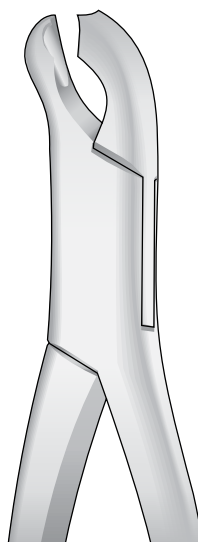
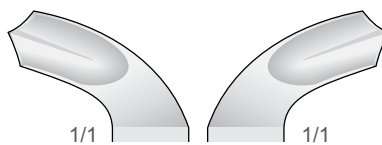

AM-17
 Fig. 17

Untere Molaren
 Lower Molars
 Molari inferiori
 Molares inferiores
 Molaires inférieures

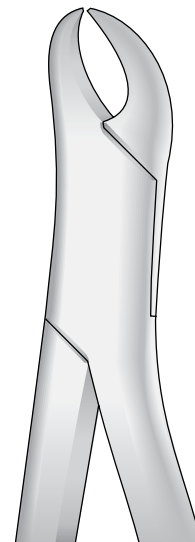
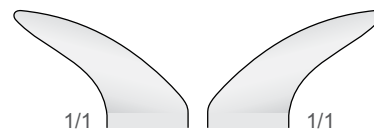

AM-23
 Fig. 23

Untere Molaren
 Lower Molars
 Molari inferiori
 Molares inferiores
 Molaires inférieures

Extracting Forceps, American Pattern

Zahnzangen, Amerikanische Form
Pinze per estrazione, Forma Americana
Pinzas da extracción, Forma Americana
Daviers, Forme Américaine

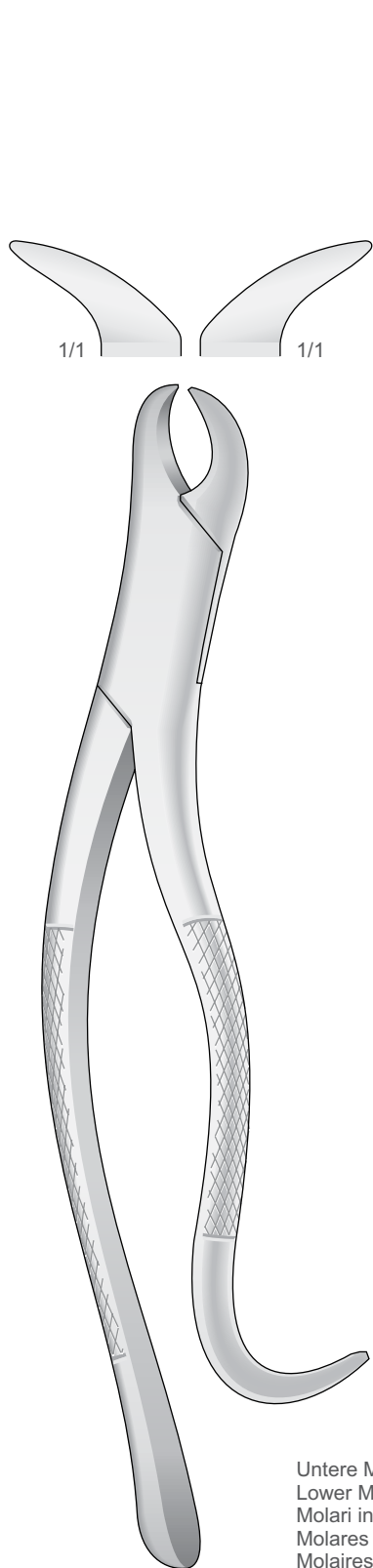

AM-16
Fig. 16

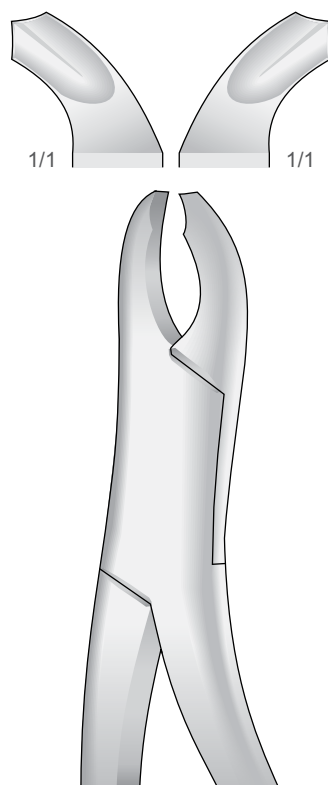

AM-103
Fig. 103

Untere Schneidezähne, Prämolaren, Wurzeln
Lower Incisors, Premolars, Roots
Incisivi, premolari, radici inferiori
Incisivos, premolares, raices inferiores
Incisives, prémolaires, racines inférieures

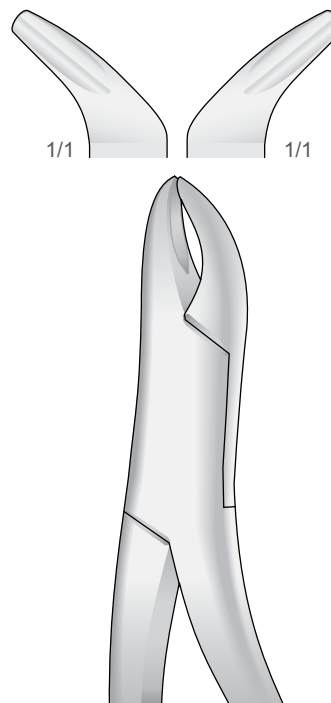

AM-103
Fig. 103

Untere Schneidezähne, Prämolaren, Wurzeln
Lower Incisors, Premolars, Roots
Incisivi, premolari, radici inferiori
Incisivos, premolares, raices inferiores
Incisives, prémolaires, racines inférieures

Extracting Forceps, American Pattern

Zahnzangen, Amerikanische Form
 Pinze per estrazione, Forma Americana
 Pinzas da extracción, Forma Americana
 Daviers, Forme Américaine

Forceps

Pinzetten
 Pinzas
 Pinces
 Pinzei

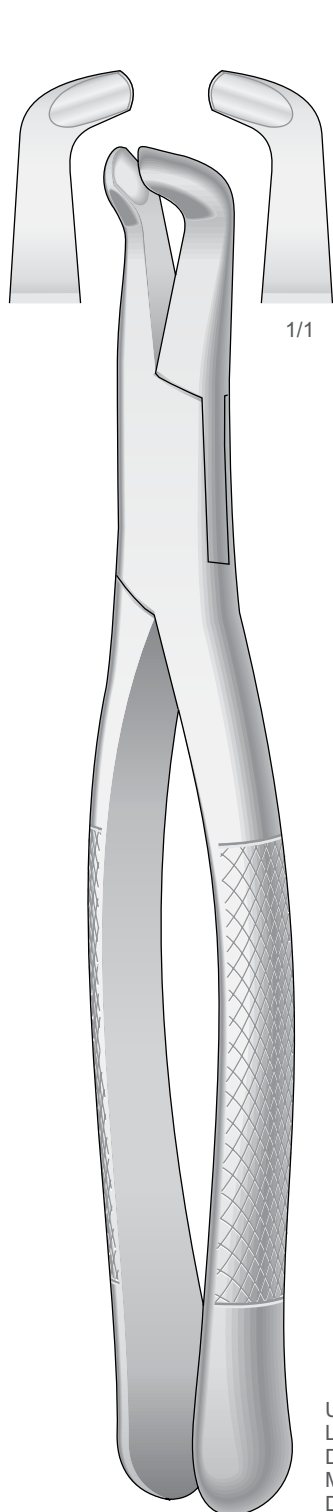

AM-222
 Fig. 222

Untere Weisheitszähne
 Lower wisdom teeth
 Denti del giudizio inferiori
 Muelas del juicio inferiores
 Dent de sagesse inférieures

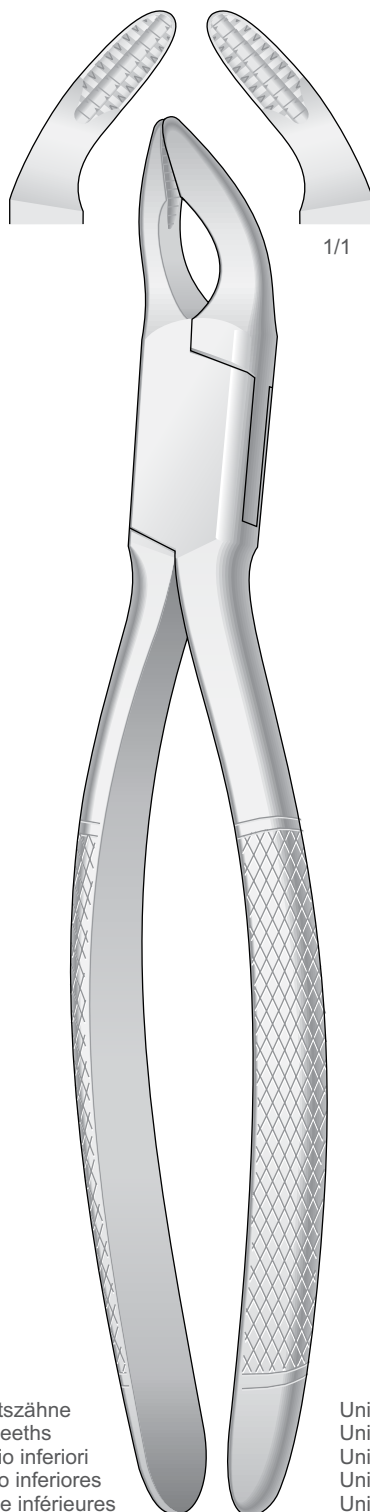

COHEN
AM-250

Universal
 Universal
 Universale
 Universal
 Universel

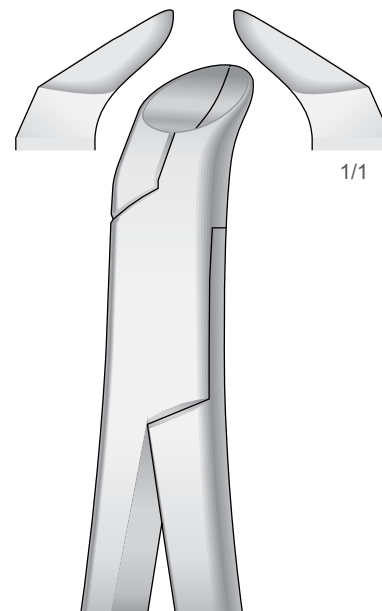

PHYSICK
AM-5
 Fig. 5

Untere Weisheitszähne
 Lower wisdom teeth
 Denti del giudizio inferiori
 Muelas del juicio inferiores
 Dent de sagesse inférieures

Extracting Forceps, American Pattern

Zahnzangen, Amerikanische Form
 Pinze per estrazione, Forma Americana
 Pinzas da extracción, Forma Americana
 Daviers, Forme Américaine

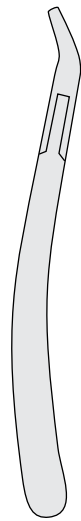
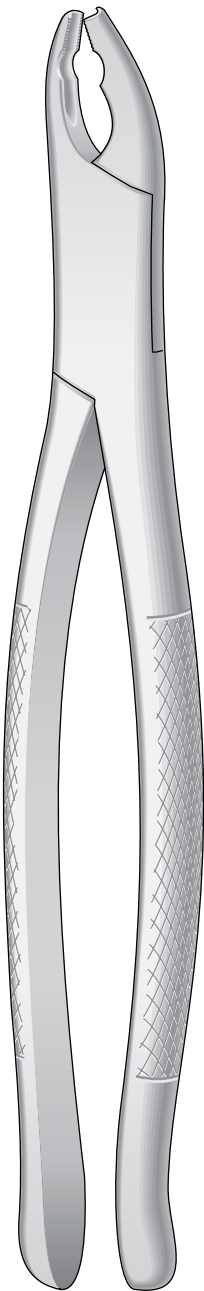
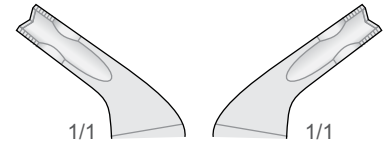
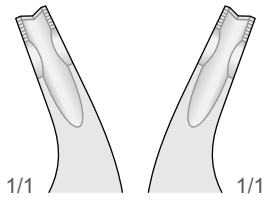

Obere
 Upper
 Superiori
 Superiores
 Supérieures

Prämolaren, Schneidezähne und Wurzeln
 Bicuspid, incisors and roots
 Premolari, incisivi e radici
 Premolares, incisivos y raíces
 Premolaires, incisives et racines



Untere
 Lower
 Inferiori
 Inferiores
 Inférieures

Prämolaren, Schneidezähne und Wurzeln
 Bicuspid, incisors and roots
 Premolari, incisivi e radici
 Premolares, incisivos y raíces
 Premolaires, incisives et racines

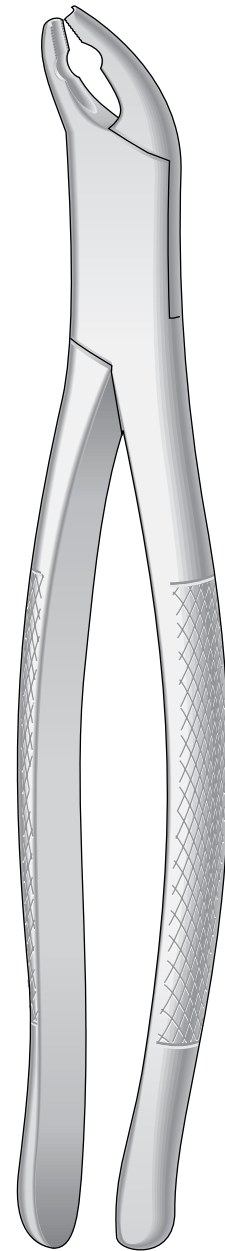

AM-150X
 Fig. 150AS

AM-151X
 Fig. 151AS

Extracting Forceps, American Pattern

Zahnzangen, Amerikanische Form
 Pinze per estrazione, Forma Americana
 Pinzas da extracción, Forma Americana
 Daviers, Forme Américaine

Forceps

Pinzetten
 Pinzas
 Pincés
 Pinzei

Für Kinder
 For children
 Per bambini
 Para niños
 Pour enfants

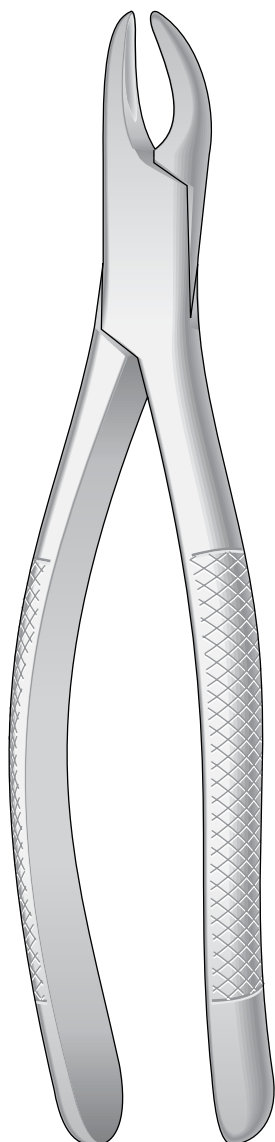
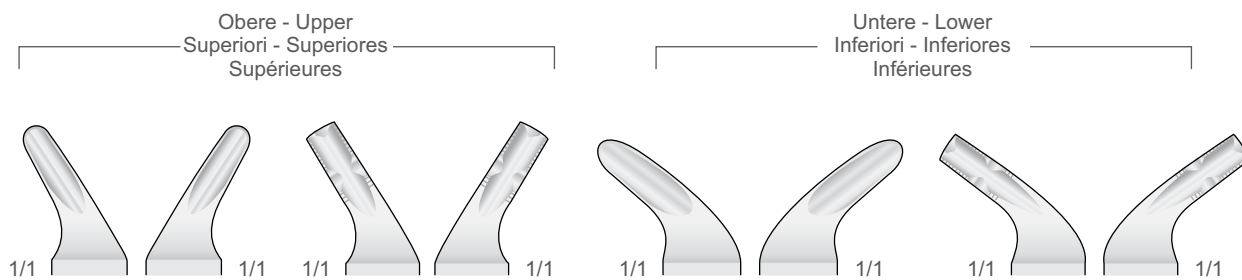

CRYER
AM-150S
 Fig.150 S

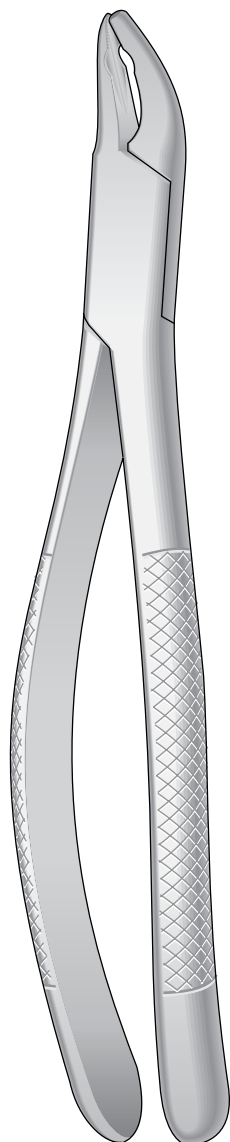

AM-150AS
 Fig.150 XAS

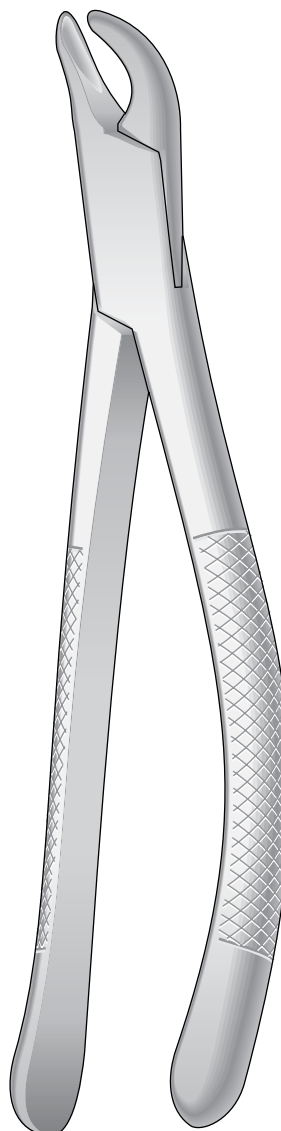

CRYER
AM-151S
 Fig.151 S

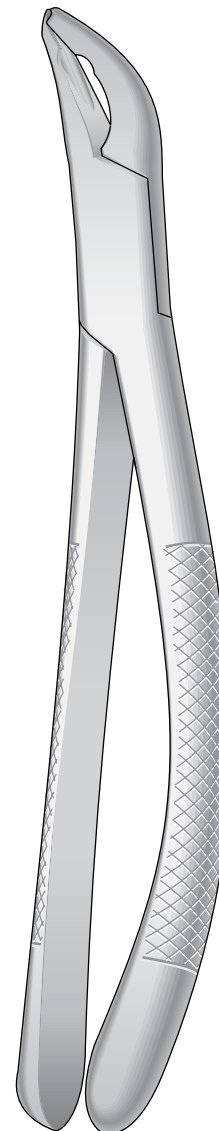

AM-151AS
 Fig.151 XAS

Extracting Forceps, American Pattern

Zahnzangen, Amerikanische Form
 Pinze per estrazione, Forma Americana
 Pinzas da extracción, Forma Americana
 Daviers, Forme Américaine

Geriefte - Serrated - Striata - Estriadas - Striées

Obere Schneidezähne, Prämolaren, Wurzeln
 Upper incisors, premolars, roots
 Incisivi, premolari e radici superiori
 Incisivos, premolares y raíces superiores
 Incisives, premolaires et racines supérieures

Untere Schneidezähne, Prämolaren, Wurzeln
 Lower incisors, premolars, roots
 Incisivi, premolari e radici inferiori
 Incisivos, premolares y raíces inferiores
 Incisives, premolaires et racines inférieures

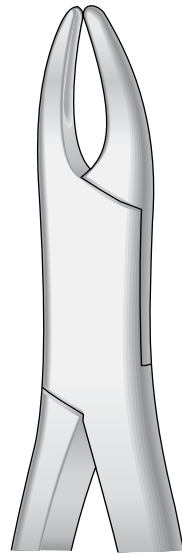
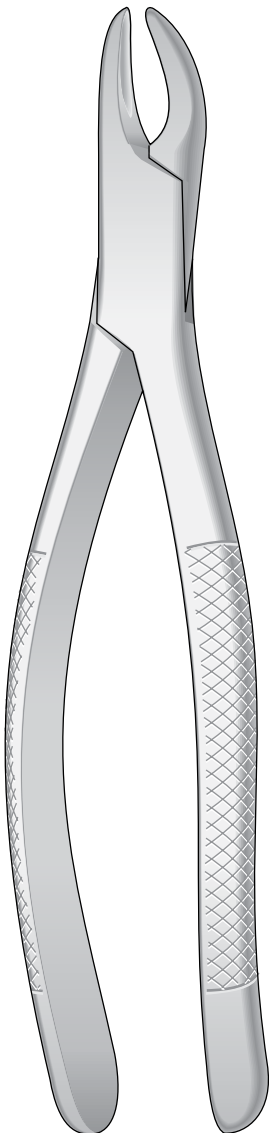
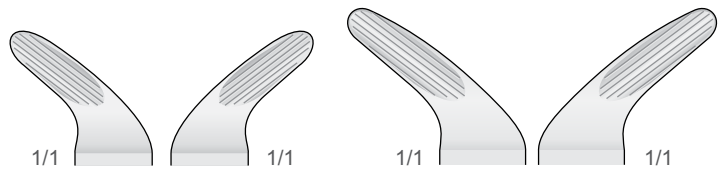
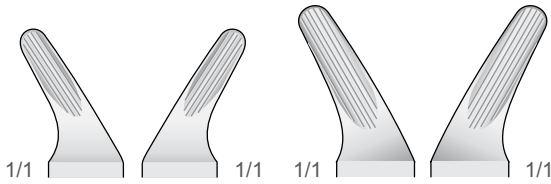

CRYER
AMG-150
 Fig. 150

Für Erwachsene
 For adults
 Per adulti
 Para adultos
 Pour adults

Für Kinder
 For children
 Per bambini
 Para niños
 Pour enfants

CRYER
AMG-150S
 Fig.150 S

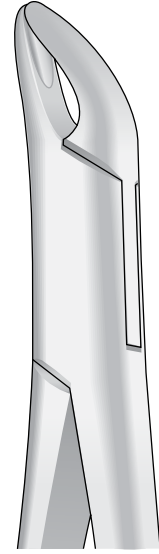
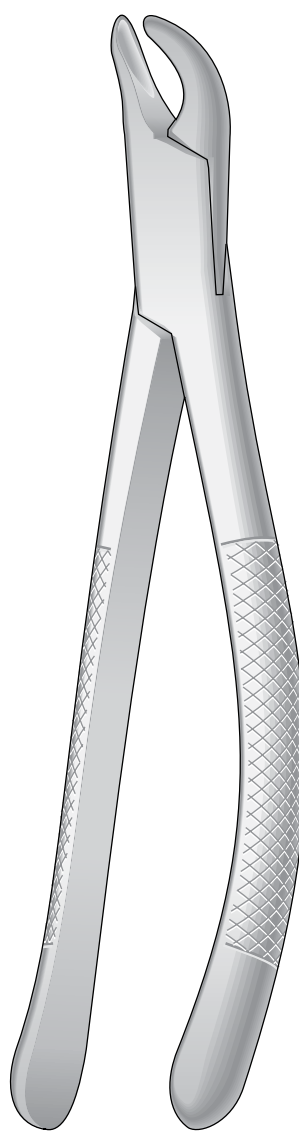

CRYER
AMG-151
 Fig. 151

Für Erwachsene
 For adults
 Per adulti
 Para adultos
 Pour adults

Für Kinder
 For children
 Per bambini
 Para niños
 Pour enfants

CRYER
AMG-151S
 Fig.151 S

Extracting Forceps

Zahnzangen
Pinze per estrazione
Pinzas da extracción
Daviers

Forceps

Pinzetten
Pinzas
Pinces
Pinzei

Schneidezähne, Eckzähne, Wurzeln
Incisors, bicuspid and roots
Incisivi, canini e radici
Incisivos, caninos y raices
Incisives, canines et racines

Molaren
Molars
Molari
Molares
Molaires

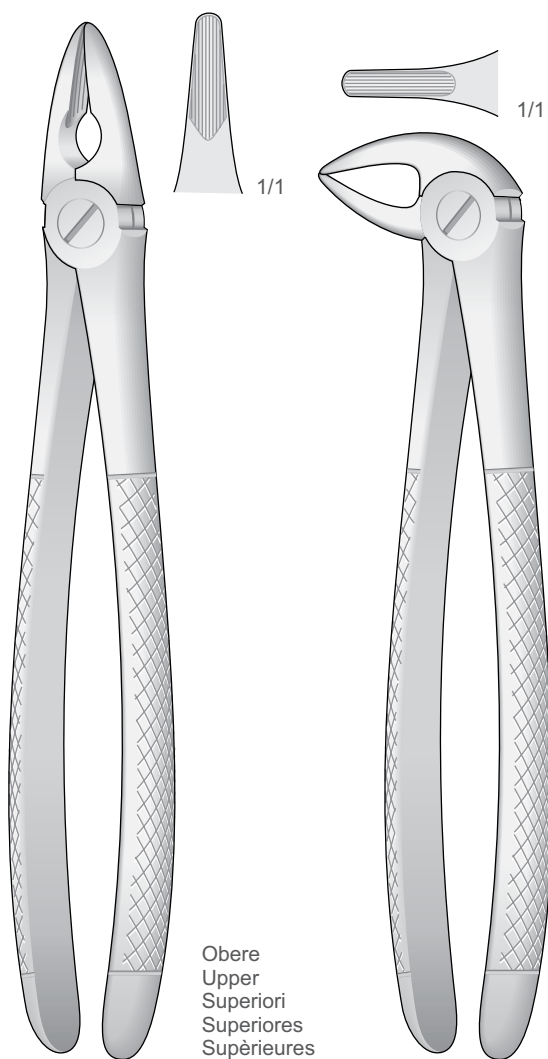

MEAD
MD-1

MEAD
MD-3

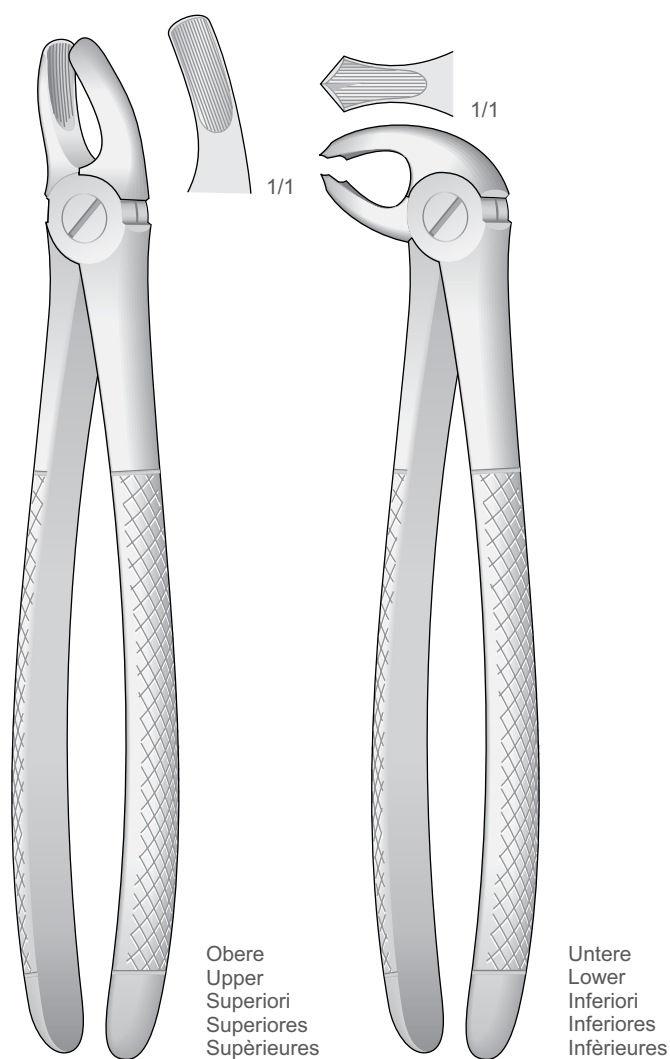

MEAD
MD-2

MEAD
MD-4

Extracting Forceps for children, American Pattern

Kinderzahnzangen, Amerikanische Form
Pinze per estrazione per bambini, Forma Americana
Forceps dentales para niños, Forma Americana
Daviers pour enfants, Forme Américaine

Molaren
Pedo Lower Molars
Molari
Molares
Molaires

Molaren
Pedo Lower Molars
Molari
Molares
Molaires

Zähne und wurzeln
Pedo upper incisors
Bicuspid and roots
Denti e radici
Dientes y raíces
Dentes et racines

Zähne und wurzeln
Pedo lower incisors
Bicuspid and roots
Denti e radici
Dientes y raíces
Dentes et racines

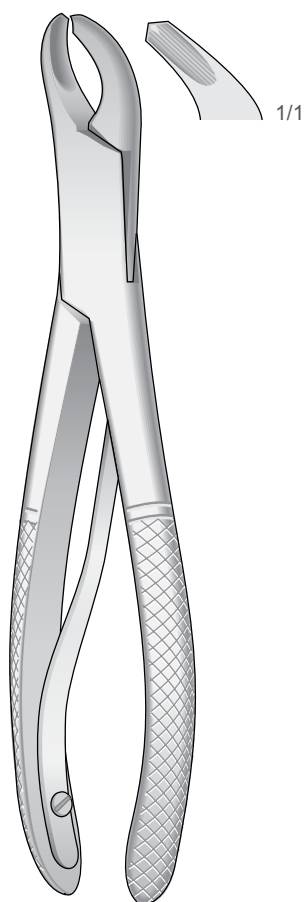

PEB-17S
Fig. 17SK

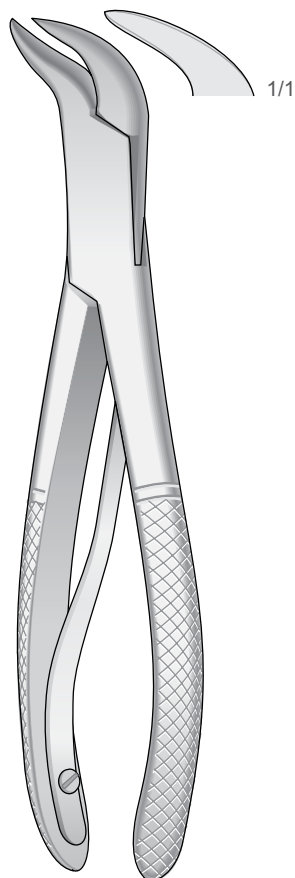

PEB-23S
Fig. 23SK

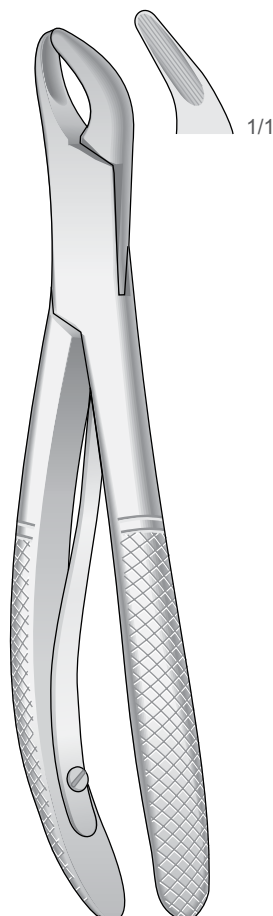

PEB-150S
Fig. 150SK

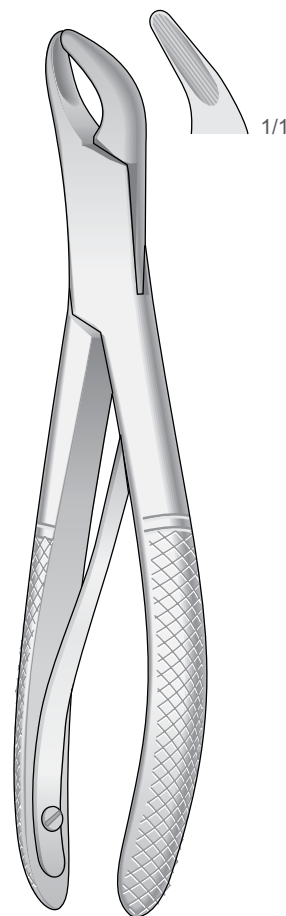

PEB-151S
Fig. 151SK

Extracting Forceps for children

Kinderzahnzangen
 Pinze per estrazione per bambini
 Forceps dentales para niños
 Daviers pour enfants

Forceps

Pinzette
 Pinzas
 Pincas
 Pinzei

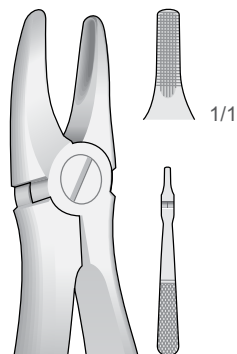

PEB-1
 Fig. 137

Obere Schneidezähne
 Upper Incisors
 Incisivi superiori
 Incisivos superiores
 Incisives supérieures

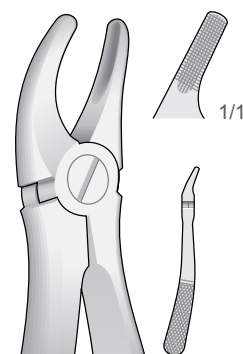

PEB-2
 Fig. 139

Obere Prämolaren
 Upper Premolars
 Premolari superiori
 Premolares superiores
 Prémolaires supérieures

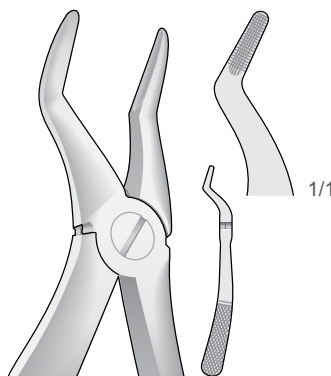

PEB-4
 Fig. 51S

Obere Wurzeln
 Upper roots
 Radici superiori
 Raíces superiores
 Racines supérieures

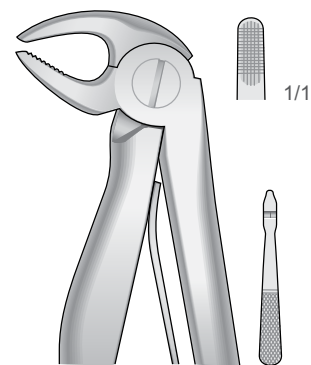

PEB-5
 Fig. 5

Untere Schneidezähne
 Lower incisors
 Incisivi inferiori
 Incisivos inferiores
 Incisives inférieures

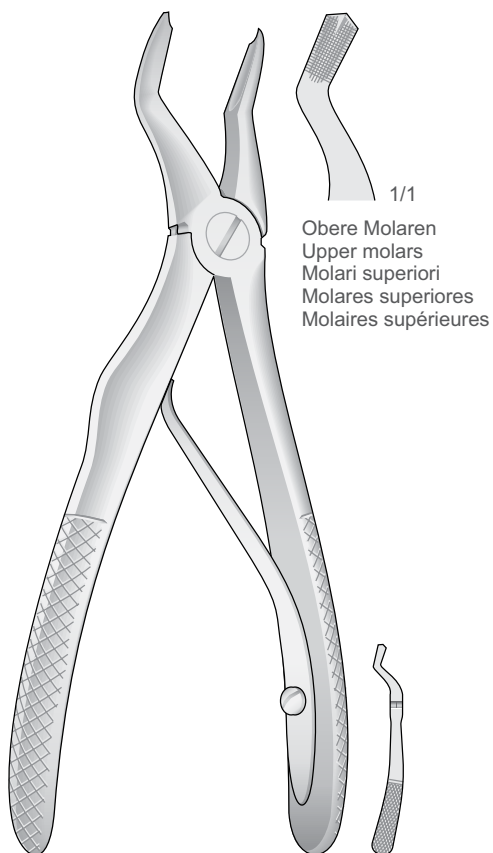

PEB-3

Obere Molaren
 Upper molars
 Molari superiori
 Molares superiores
 Molaires supérieures

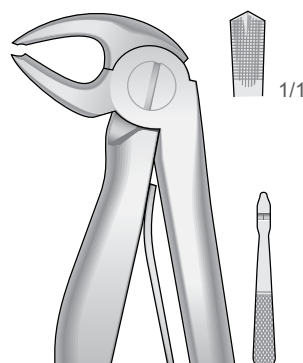

PEB-6
 Fig. 6

Untere Molaren
 Lower Molars
 Molari inferiori
 Molares inferiores
 Molaires inférieures

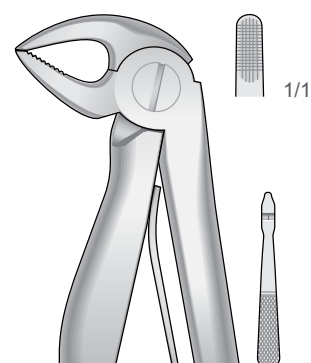

PEB-7
 Fig. 7

Untere Wurzeln
 Lower roots
 Radici inferiori
 Raíces inferiores
 Racines inférieures

Root Fragment Forceps

Wurzelfragmentinstrumente

Strumenti per frammenti di radici

Instrumentos para fragmentos de raíces

Instrumentes pour fragments de racines

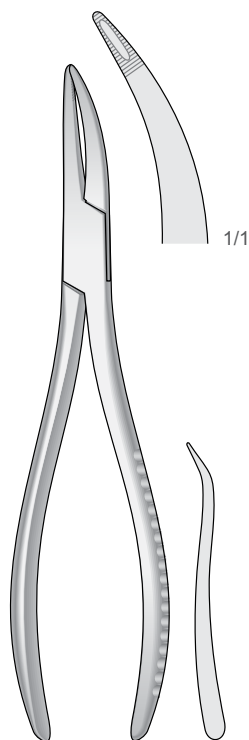

Obere Wurzeln, Universal
Upper roots, Universal
Radici superiori, Universale
Raíces superiores, Universal
Racines superieures, Universel

**WITZEL
DK-26**
170 mm

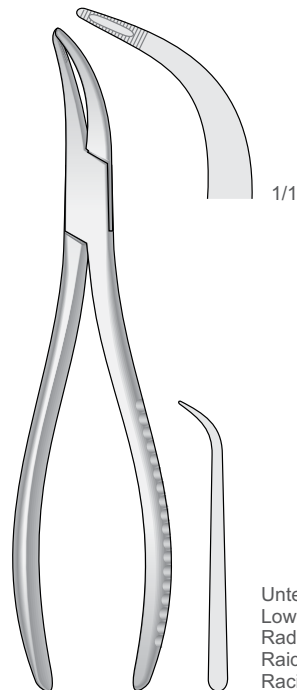

Untere Wurzeln, Universal
Lower roots, Universal
Radici inferiori, Universale
Raíces inferiores, Universal
Racines inferieures, Universel

**WITZEL
DK-28**
165 mm

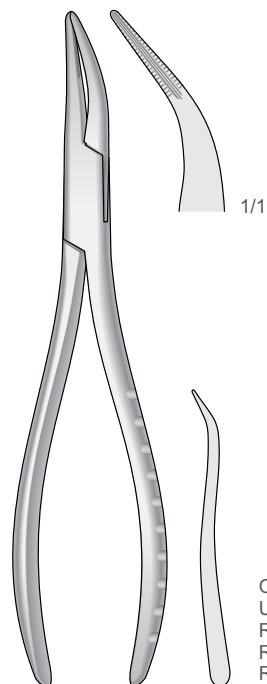

Obere Wurzeln, Universal
Upper roots, Universal
Radici superiori, Universale
Raíces superiores, Universal
Racines superieures, Universel

S-400
400 (300)
165 mm

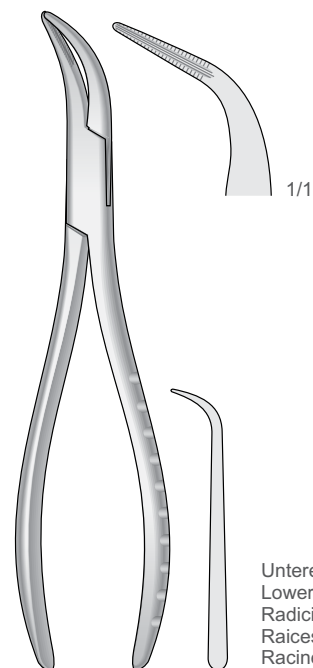

Untere Wurzeln, Universal
Lower roots, Universal
Radici inferiori, Universale
Raíces inferiores, Universal
Racines inferieures, Universel

I-401
401 (301)
160 mm

Root Fragment Forceps

Wurzelfragmentinstrumente

Strumenti per frammenti di radici

Instrumentos para fragmentos de raíces

Instruments pour fragments de racines

Forceps

Pinzette

Pinzas

Pinces

Pinzei

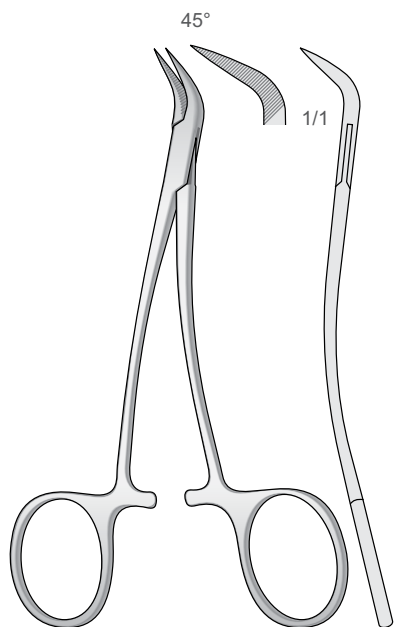

PEET
DR-40
120 mm

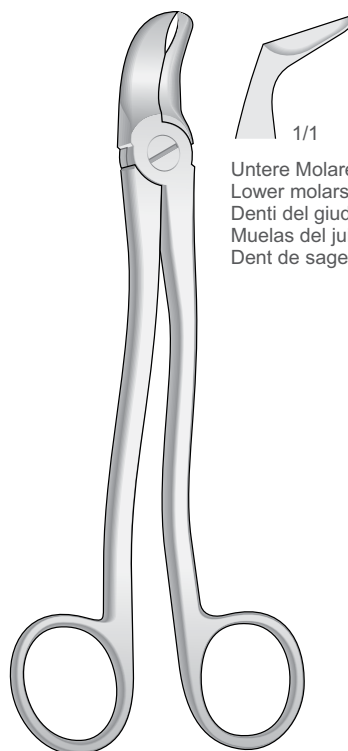

RO-1
175 mm

Untere Molaren und Weisheitszähne
Lower molars and wisdom teeth
Denti del giudizio e molari inferiori
Muelas del juicio y molares inferiores
Dent de sagesse et molaires inférieures

Wurzelfragmente
Root fragments
Frammenti di radici
Fragmentos de raíces
Fragments de racines

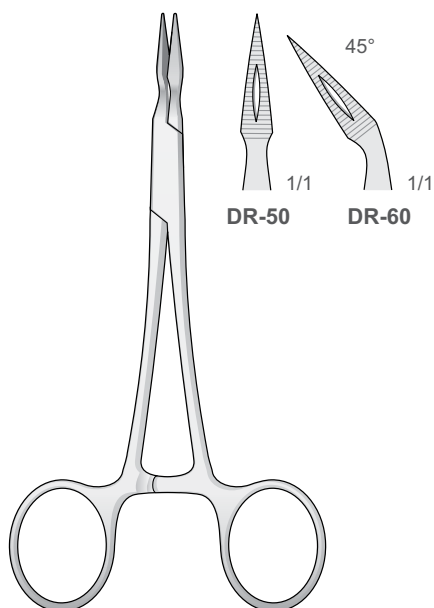

STIEGLITZ
DR-50/DR-60
140 mm

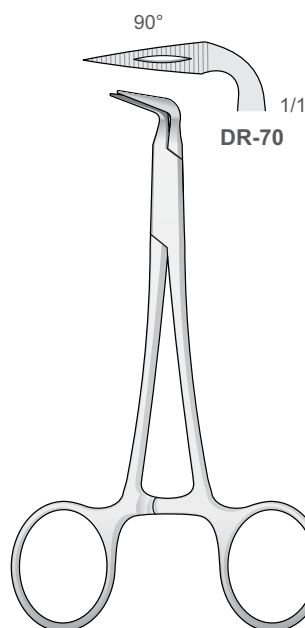

STIEGLITZ
DR-70
120 mm

Root Fragment Forceps

Wurzelfragmentinstrumente

Strumenti per frammenti di radici

Instrumentos para fragmentos de raíces

Instruments pour fragments de racines

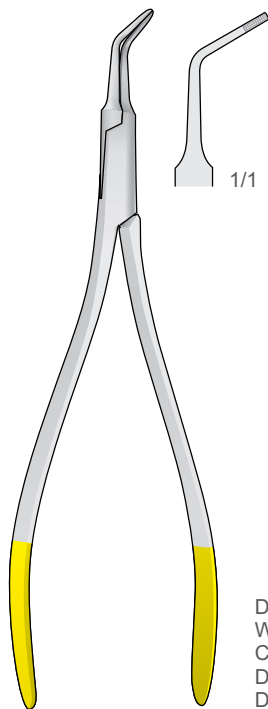

DA-01M
130 mm

Diamantiert
With Diamond
Con diamante
Diamantada
Diamantées

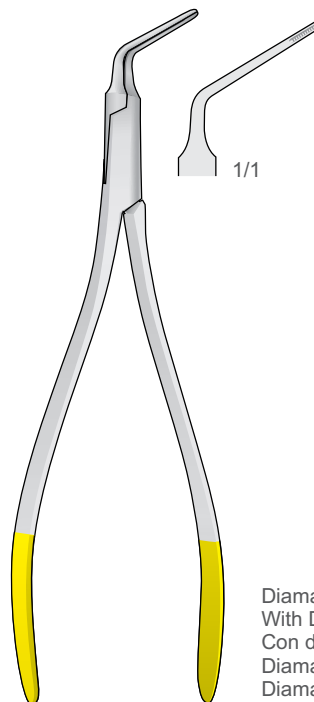

DA-10
130 mm

Diamantiert
With Diamond
Con diamante
Diamantada
Diamantées

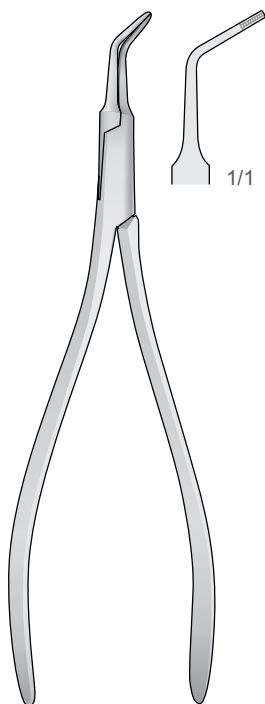

DA-01
130 mm

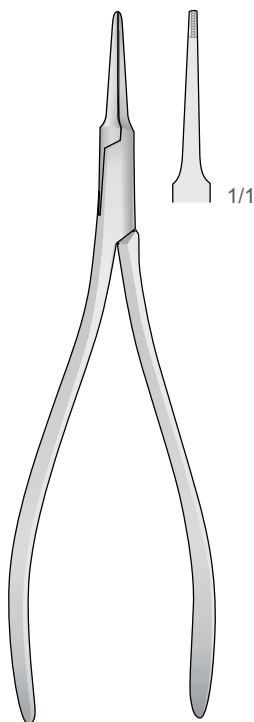

DA-02
130 mm

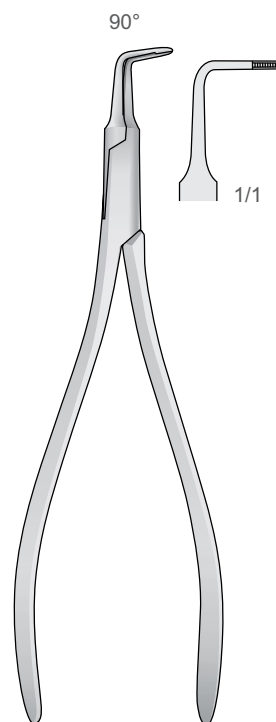

DA-03
125 mm

MSB



ELEVATOR

Root Elevators

Wurzelheber
Leve per radici
Elevadores para raíces
Elevateurs à racines

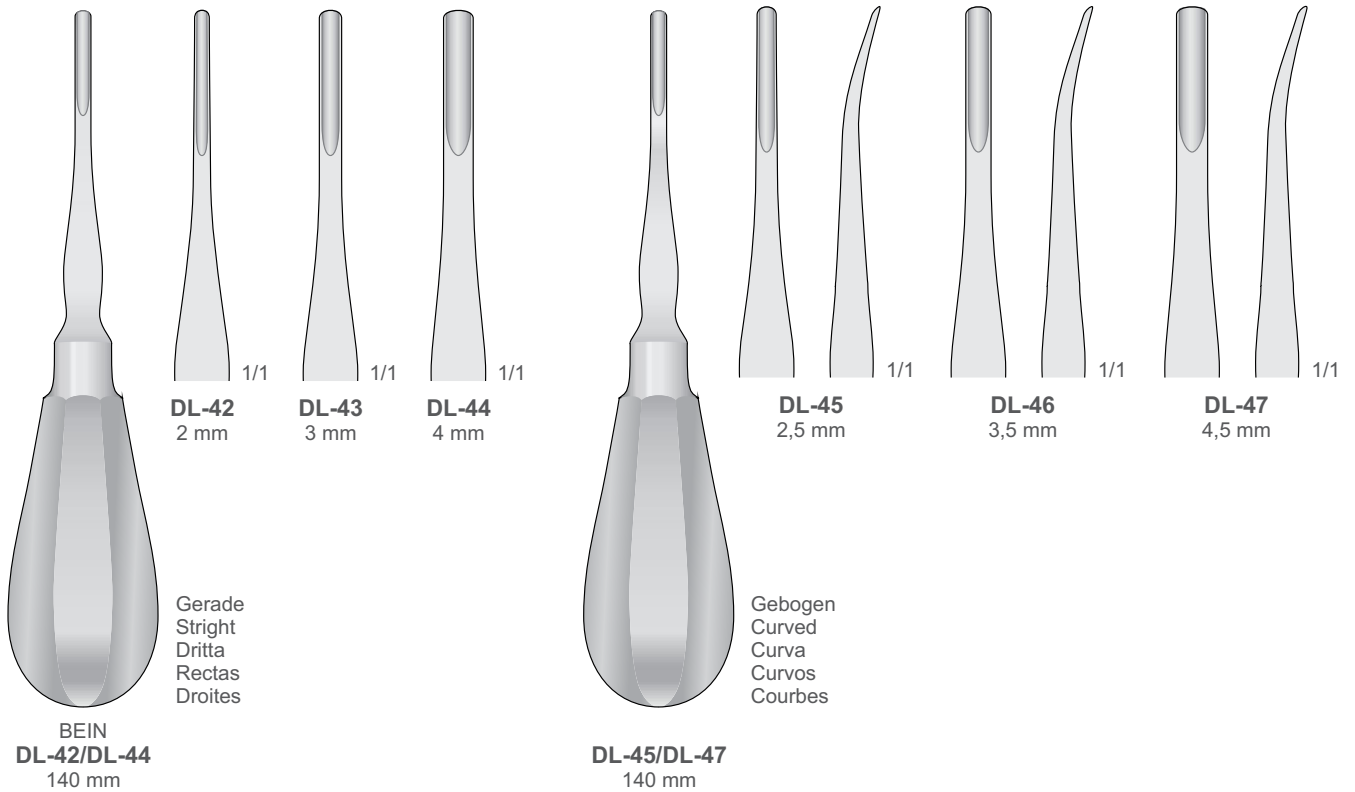

SMALL HANDLE

Luxierinstrumente | Luxating Elevators | Elevatori di lussazione | Elevadores de luxación | Élévateurs de luxation

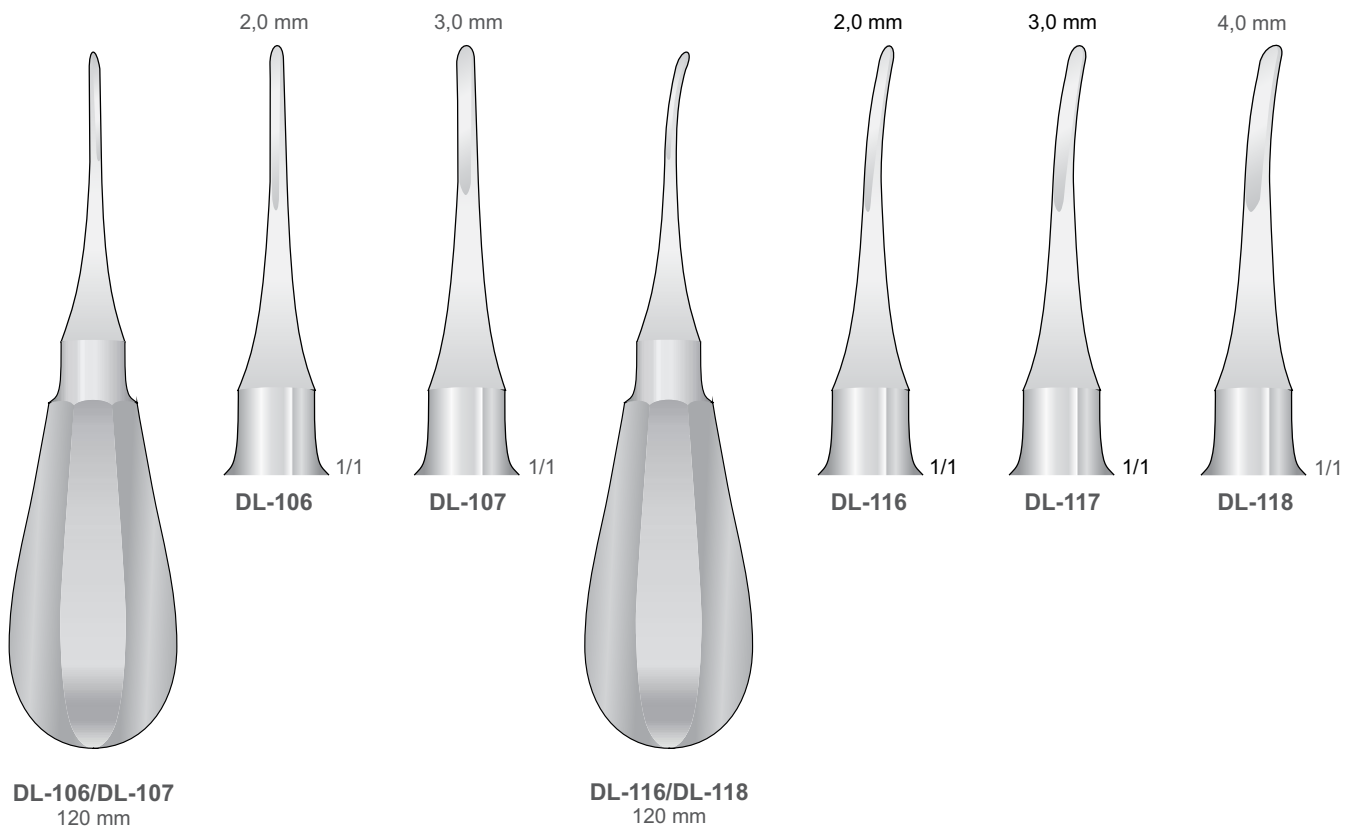

Root Elevators

Wurzelheber
Leve per radici
Elevadores para raíces
Elevateurs à racines

Elevators

Aufzüge
Ascenseurs
Ascensori
Lifty

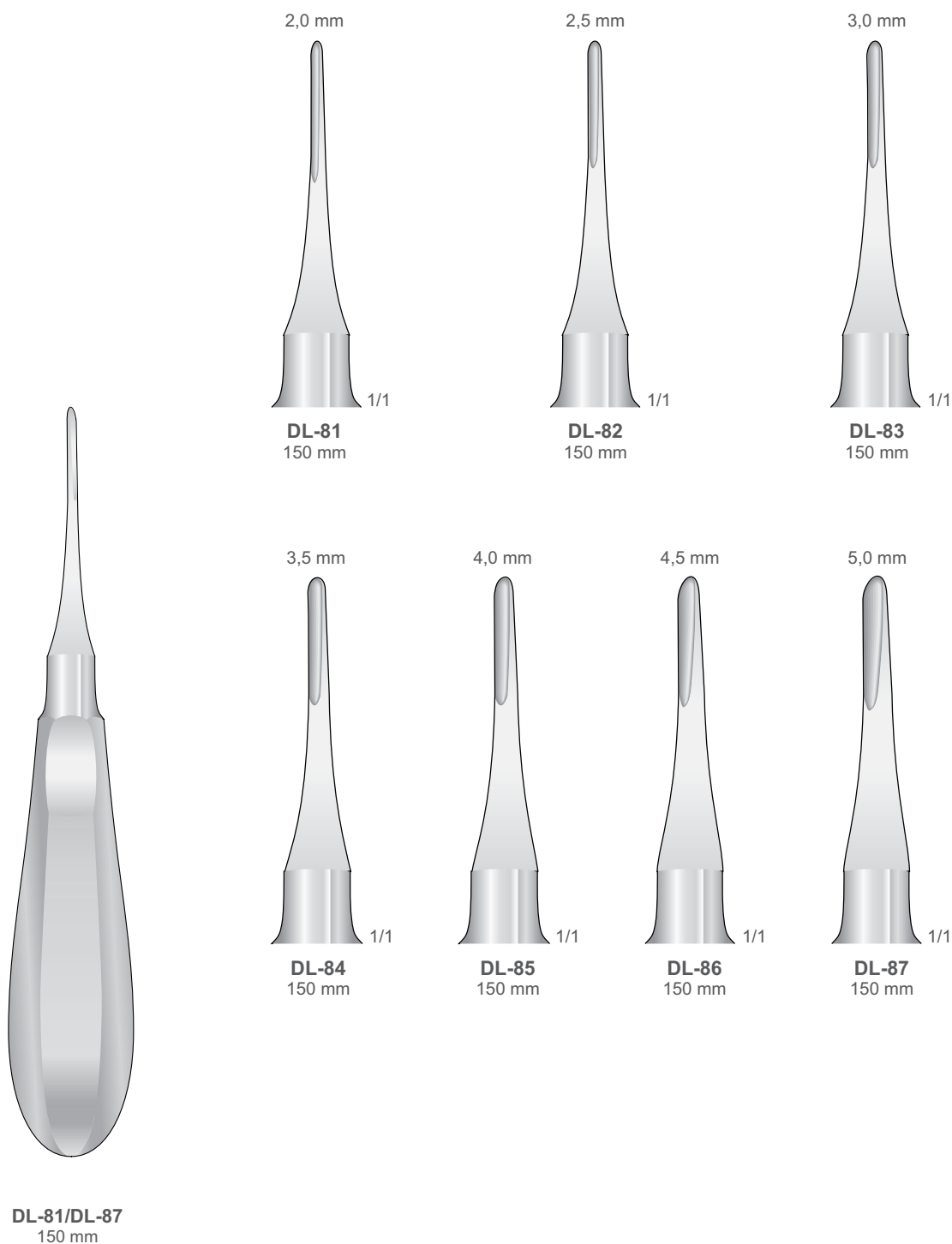

Root Elevators

Wurzelheber

Leve per radici

Elevadores para raíces

Elevateurs à racines

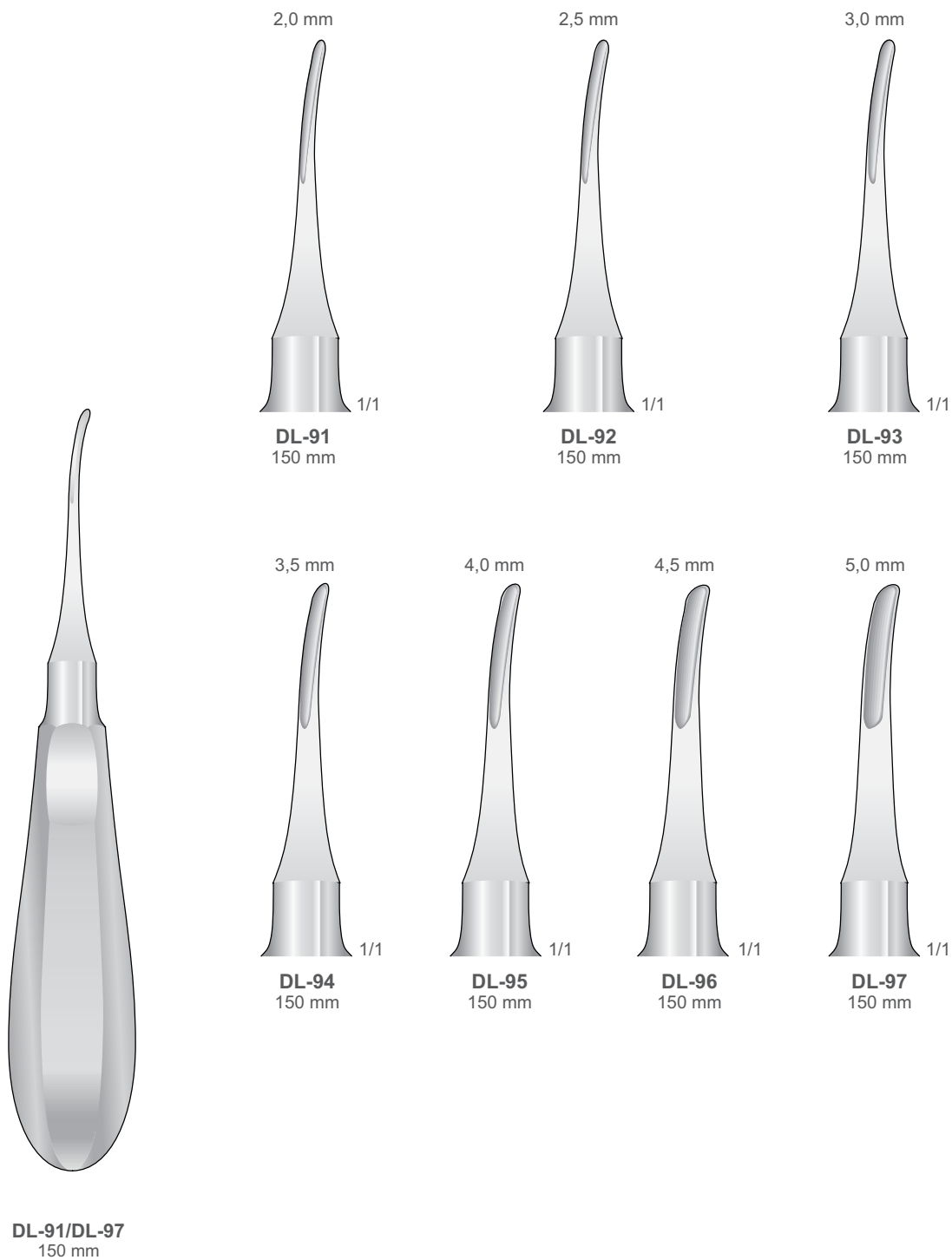

Root Elevators

Wurzelheber
Leve per radici
Elevadores para raíces
Elevateurs à racines

Elevators

Aufzüge
Ascenseurs
Ascensori
Lifty

SMALL HANDLE

Luxierinstrumente | Luxating Elevators | Elevatori di lussazione | Elevadores de luxación | Élévateurs de luxation

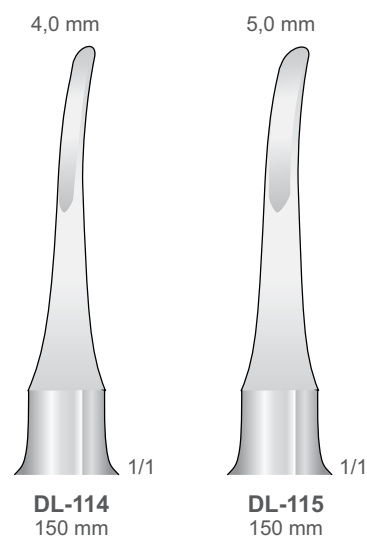
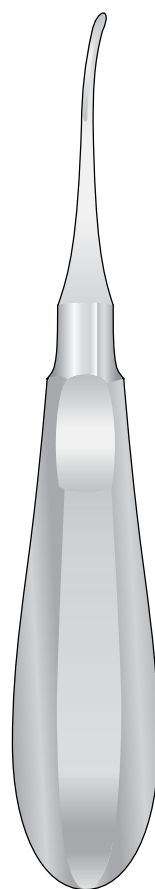
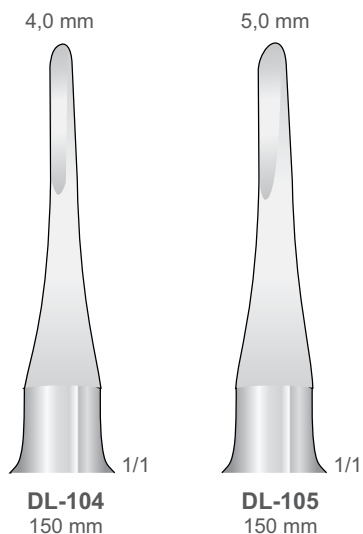
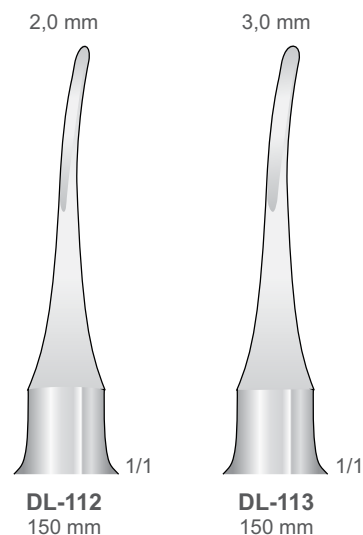
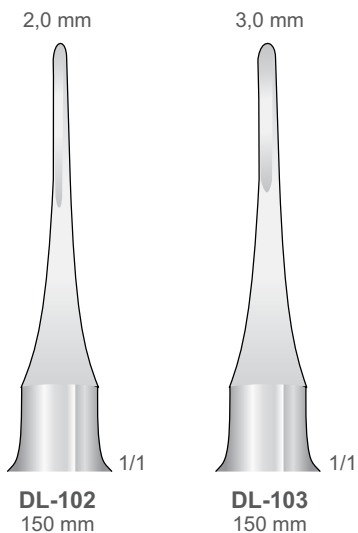

Root Elevators

Wurzelheber
 Leve per radici
 Elevadores para raíces
 Elevateurs à racines



Wurzelspitzenheber
 Root fragment Elevators
 Leve per frammenti di radice
 Elevadores para fragmentos de raíces
 Elévateurs de fragments de racines

HEIDBRINK
HE-2S
 Right # 2
 Root Tip Picks
 140 mm
SMALL HANDLE

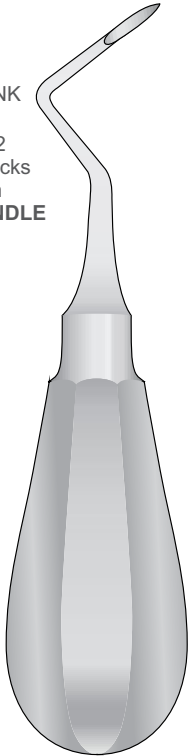

HEIDBRINK
HE-3S
 Left # 3
 Root Tip Picks
 140 mm
SMALL HANDLE

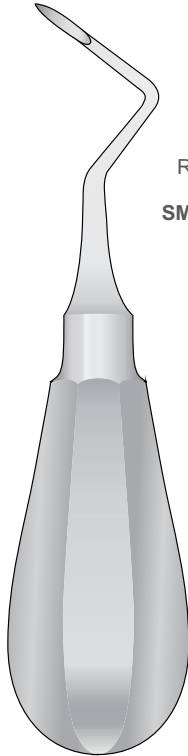

Gezahnt
 Serrated
 Dentellata
 Dentada
 Dentelé



HEIDBRINK
HE-1
 Straight # 1
 Root Tip Picks
 140 mm

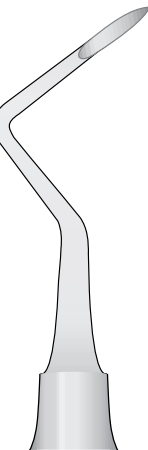
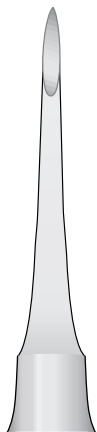

HEIDBRINK
HE-2
 Right # 2
 Root Tip Picks
 140 mm

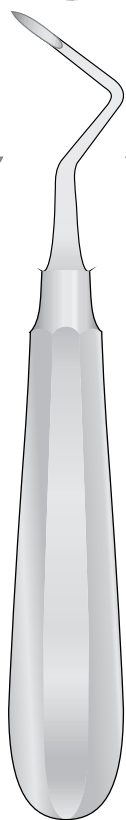

HEIDBRINK
HE-3
 Left # 3
 Root Tip Picks
 140 mm

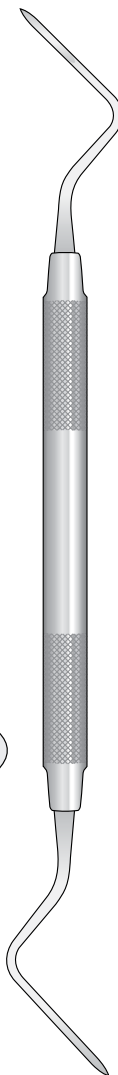

HEIDBRINK
725-1/2
 195 mm

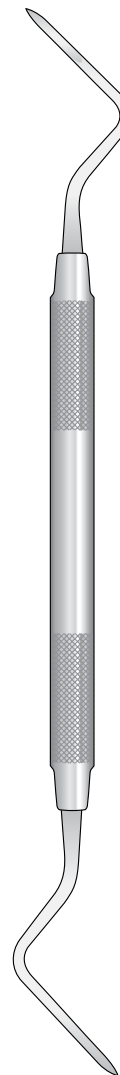

HEIDBRINK
725-3/4
 195 mm

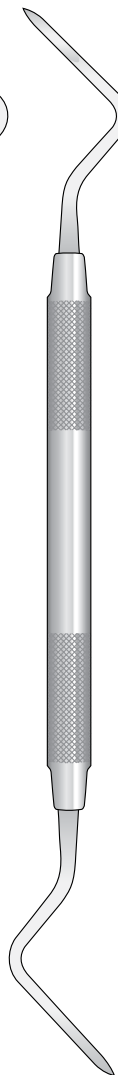

HEIDBRINK
725-5/6
 195 mm

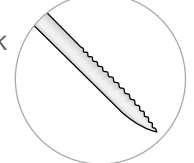
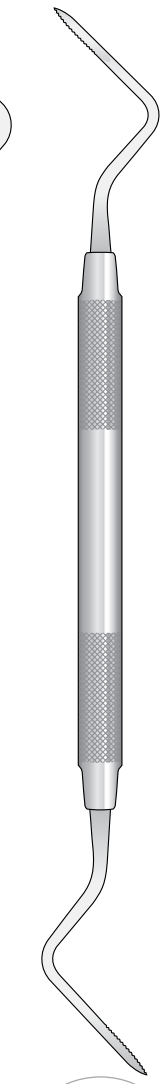

HEIDBRINK
725-3/4S
 195 mm

Root Elevators

Wurzelheber
Leve per radici
Elevadores para raíces
Élevateurs à racines

Elevators

Aufzüge
Ascenseurs
Ascensori
Lifty

Extraktionshebel für obere Weisheitszähne
Root Elevator for upper wisdom teeth
Leva per estrazione dente del giudizio superiore
Elevador de extracción de muelas del juicio superiores
Élévateur à racines pour les dents de sagesse supérieures

Wurzelheber
Root Elevators
Leve per radici
Elevadores para raíces
Élévateurs de racines

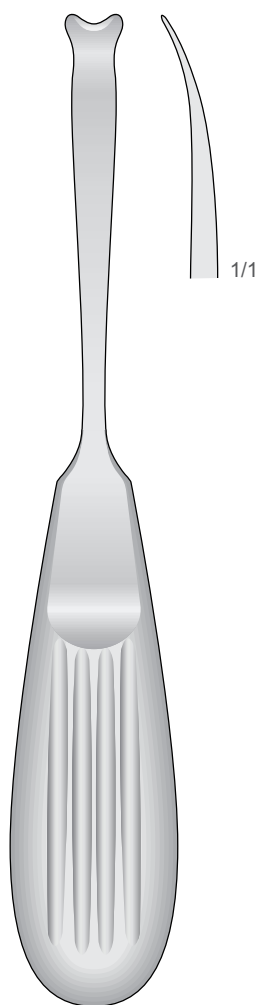

ROSIN
DL-58
160 mm



WARWICK-JAMES
DL-20
160 mm



WARWICK-JAMES
DL-21
155 mm



WARWICK-JAMES
DL-22
155 mm

Obere
Upper
Superiori
Superiores
Supérieures

Untere
Lower
Inferiori
Inferiores
Inférieures

Untere
Lower
Inferiori
Inferiores
Inférieures

Root Elevators

Wurzelheber

Leve per radici

Elevadores para raíces

Elevateurs à racines

Eine seite gezahnt
One side serrated
Un lato dentellato
Dentadura mäs lado
Dentelure sur un côté

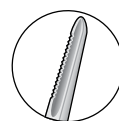
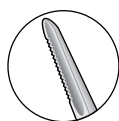
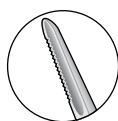

Fig. 94



DL-76
155 mm

Fig. 95



DL-77
155 mm

Fig. 100L



DL-78
155 mm

Fig. 100R



DL-79
155 mm

Root Elevators

Wurzelheber
Leve per radici
Elevadores para raíces
Elevateurs à racines

Elevators

Aufzüge
Ascenseurs
Ascensori
Lifty

Gezahnt
Serrated
Dentellate
Dentadas
Dentelé

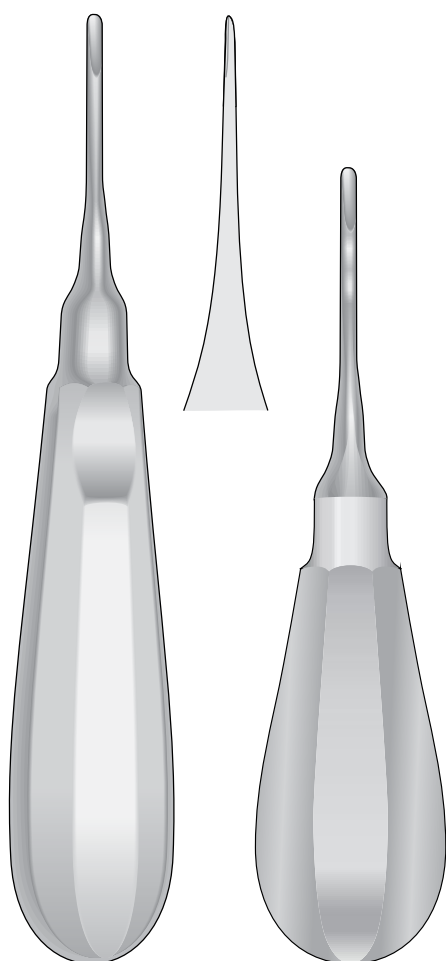
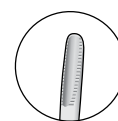

APEXO
DL-34S
301
155 mm

APEXO
DL-34S
301
130 mm
SMALL HANDLE

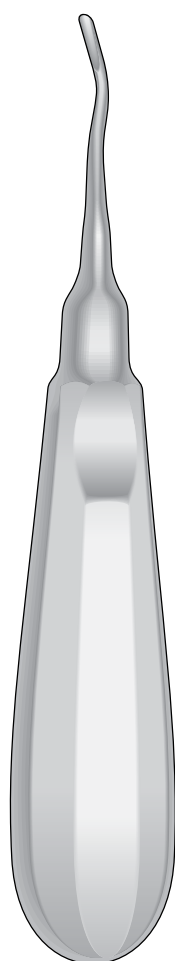

APEXO
DL-35/DL-36
155 mm

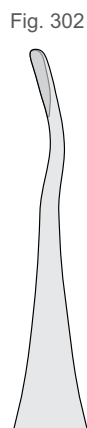

DL-35

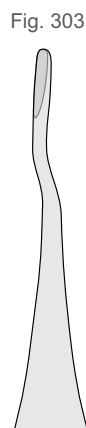

DL-36

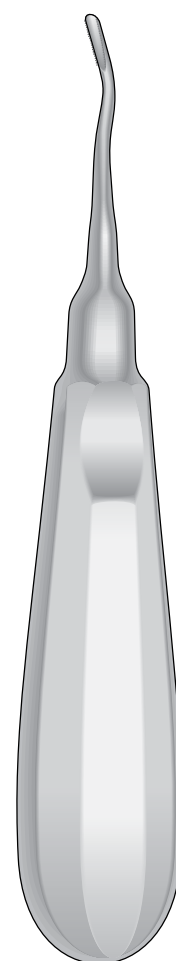

APEXO
DL-37/DL-38
155 mm

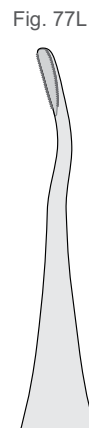

DL-37

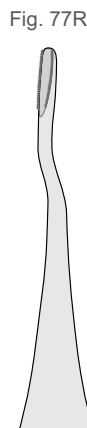

DL-38

Root Elevators

Wurzelheber

Leve per radici

Elevadores para raíces

Elevateurs à racines

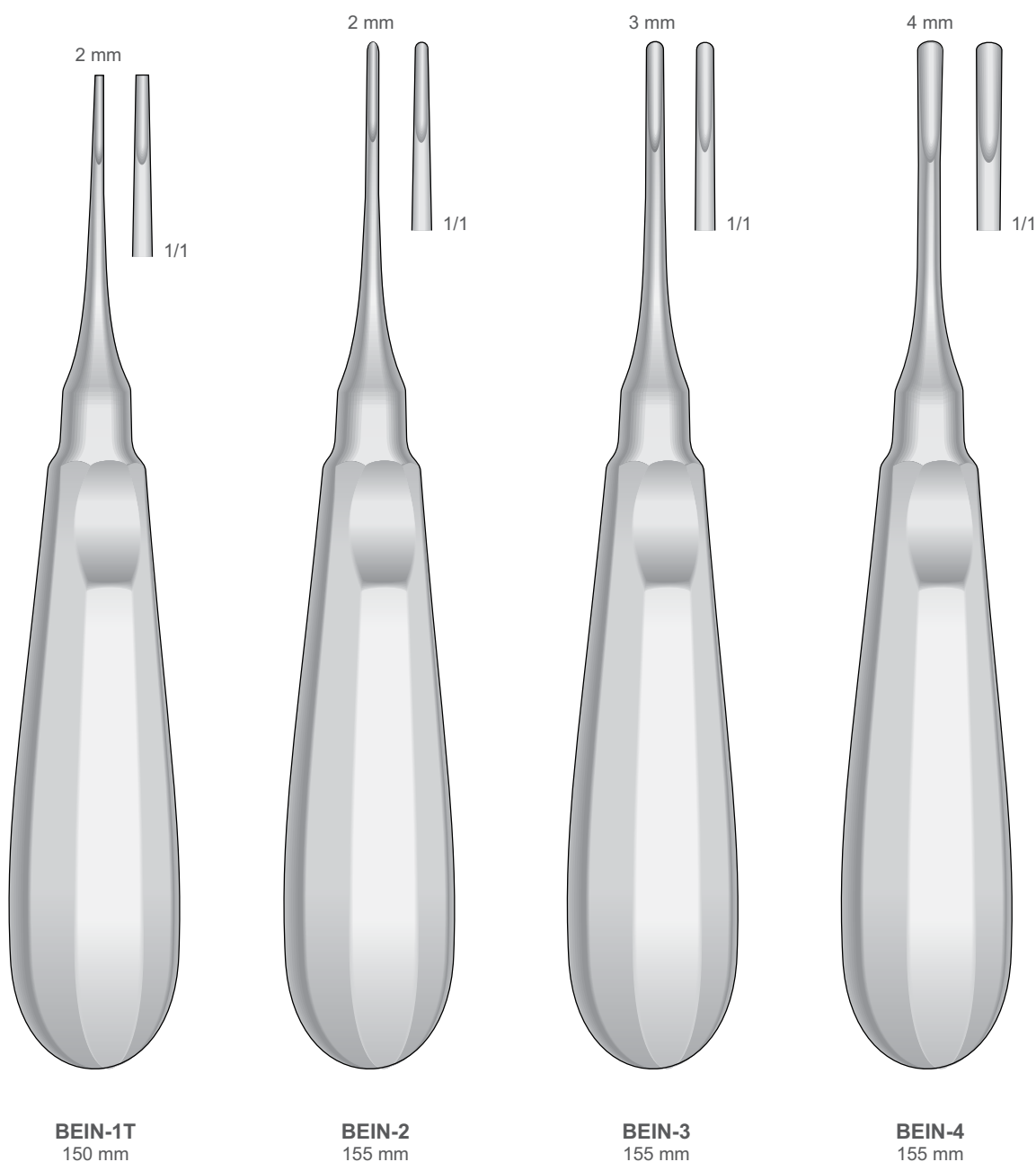

BEIN-1T
150 mm

BEIN-2
155 mm

BEIN-3
155 mm

BEIN-4
155 mm

Root Elevators

Wurzelheber
Leve per radici
Elevadores para raíces
Elevateurs à racines

Elevators

Aufzüge
Ascenseurs
Ascensori
Lifty

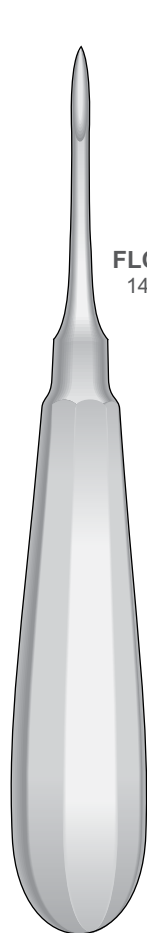

FLOHR-1
140 mm

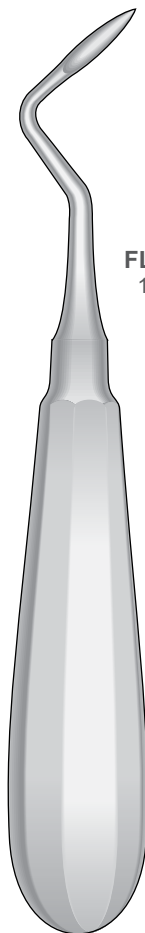

FLOHR-2
150 mm

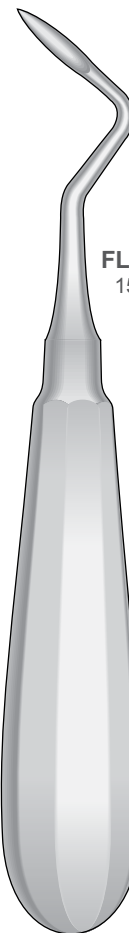

FLOHR-3
150 mm

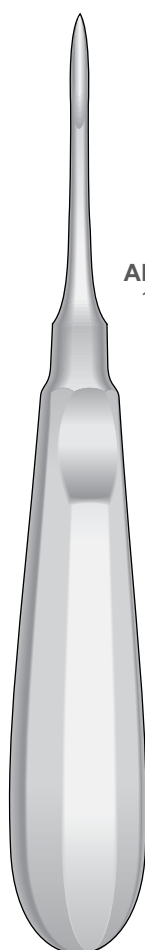

APICAL-1
155 mm

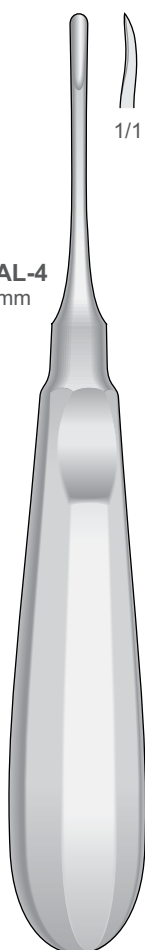

APICAL-4
155 mm

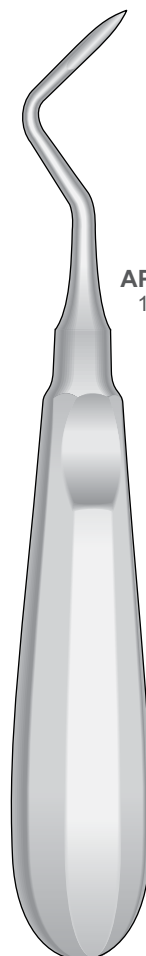

APICAL-2
155 mm

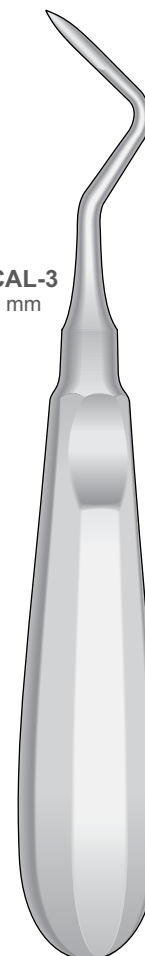

APICAL-3
155 mm

Root Elevators

Wurzelheber
 Leve per radici
 Elevadores para raíces
 Elevateurs à racines

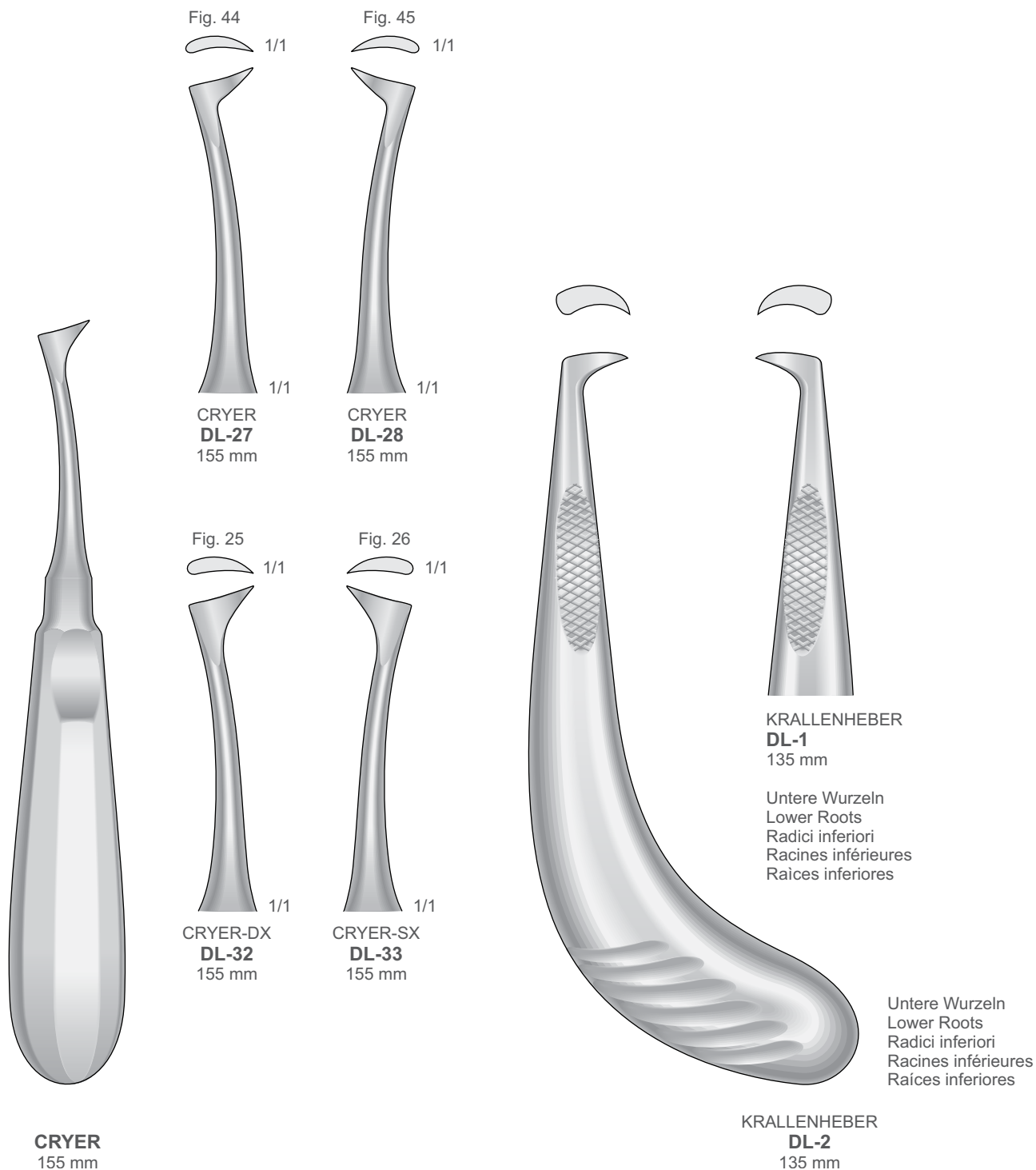

Root Elevators

Wurzelheber
 Leve per radici
 Elevadores para raíces
 Elevateurs à racines

Elevators

Aufzüge
 Ascenseurs
 Ascensori
 Lifty

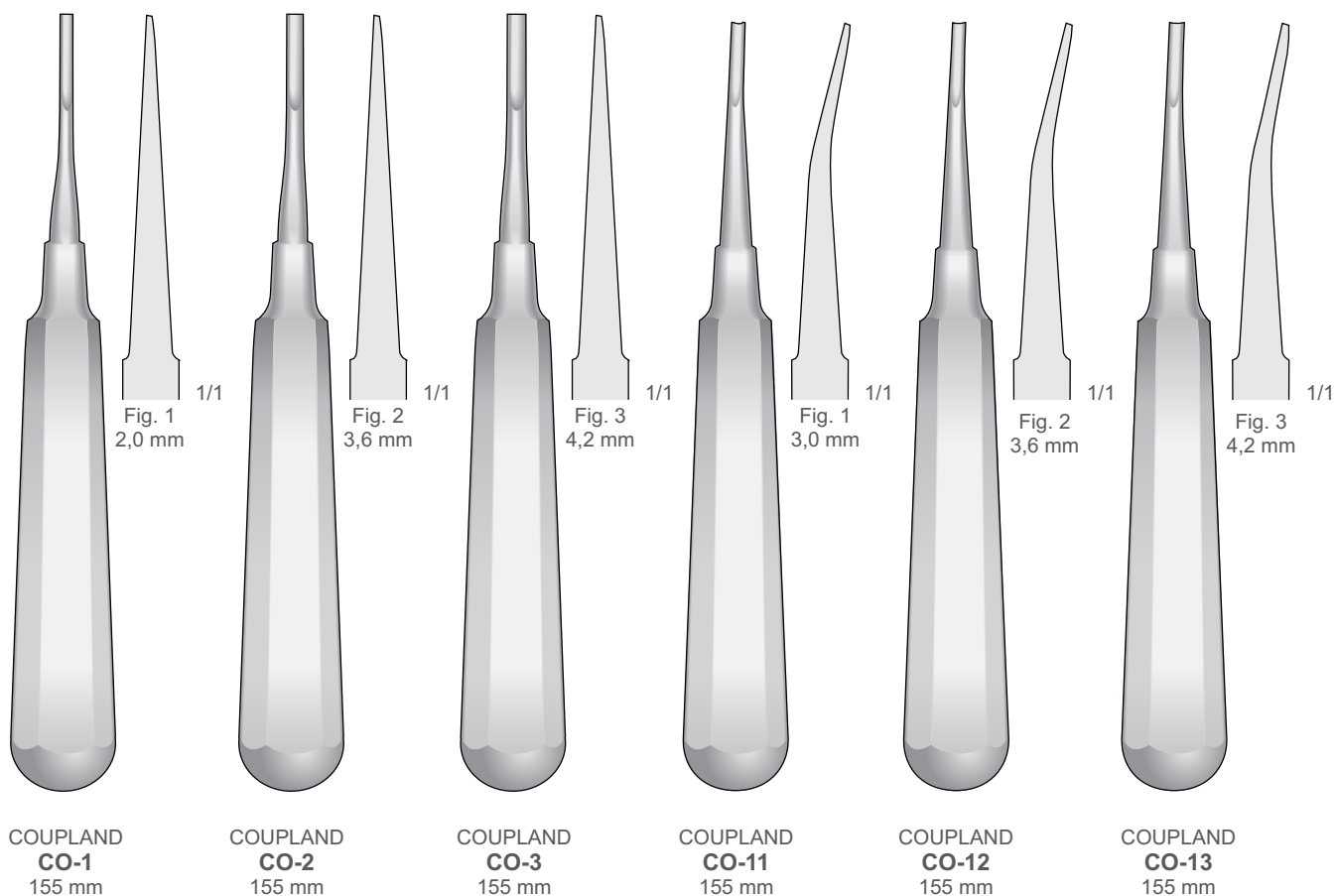
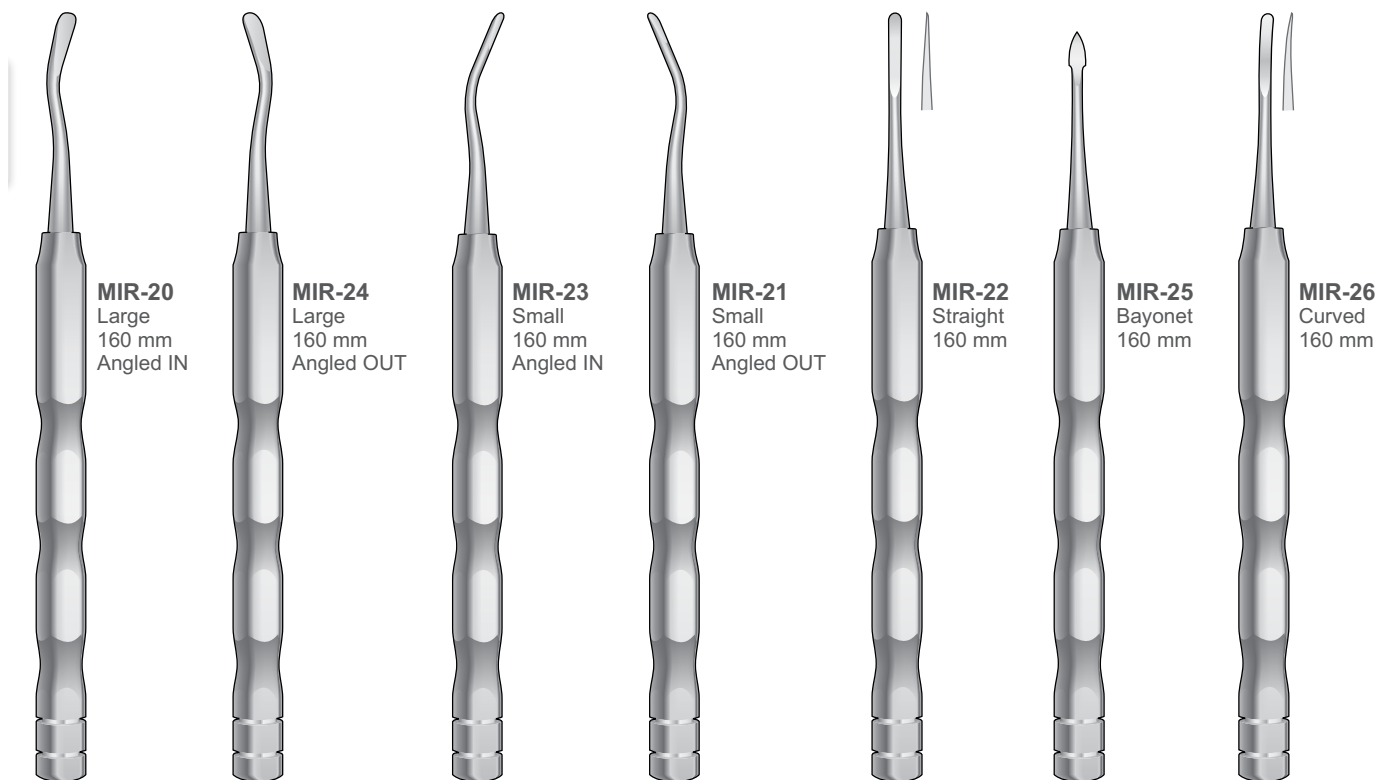

Root Elevators

Wurzelheber

Leve per radici

Elevadores para raíces

Elevateurs à racines

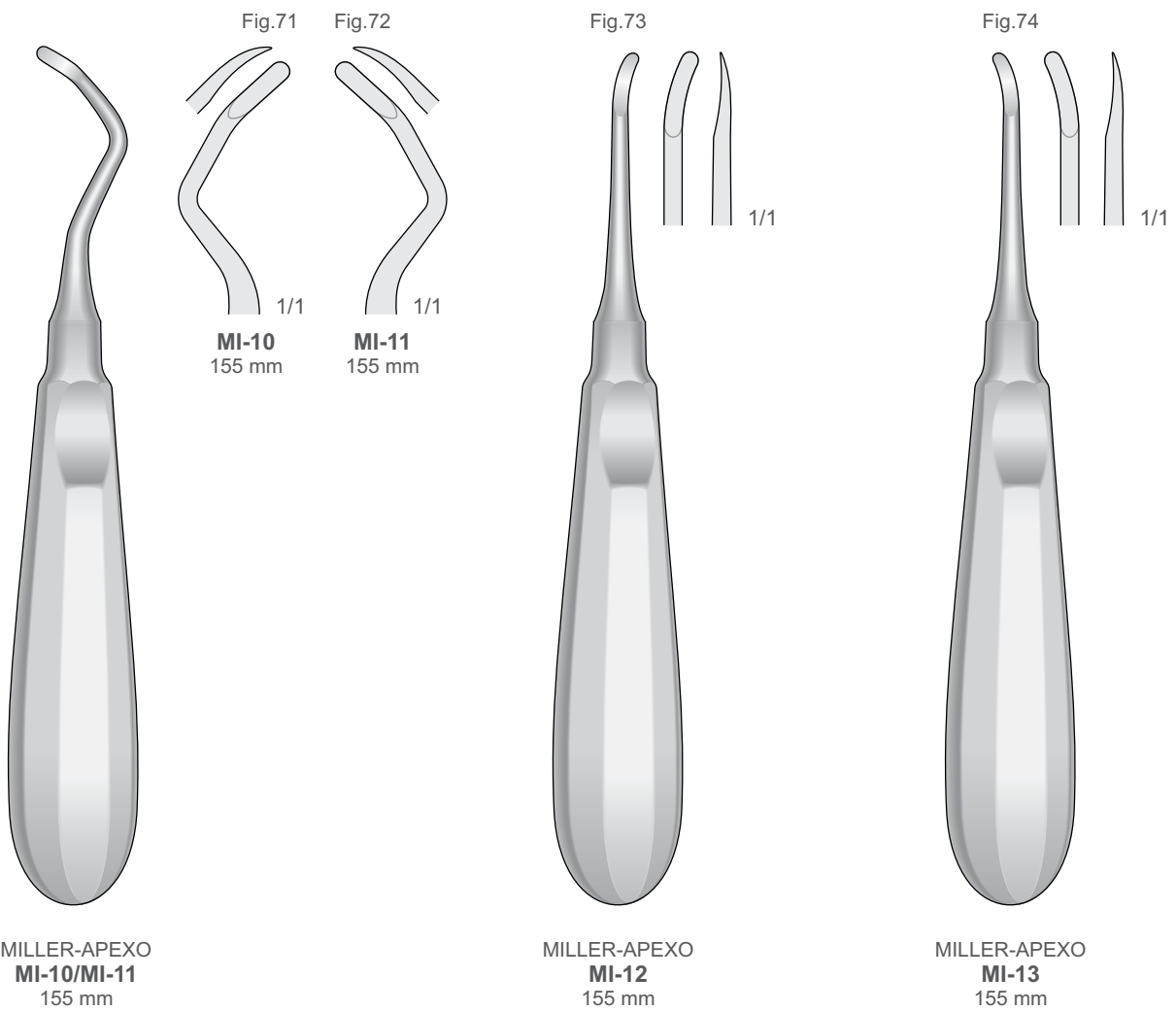

Root Elevators

Wurzelheber
Leve per radici
Elevadores para raíces
Elevateurs à racines

Elevators

Aufzüge
Ascenseurs
Ascensori
Lifty

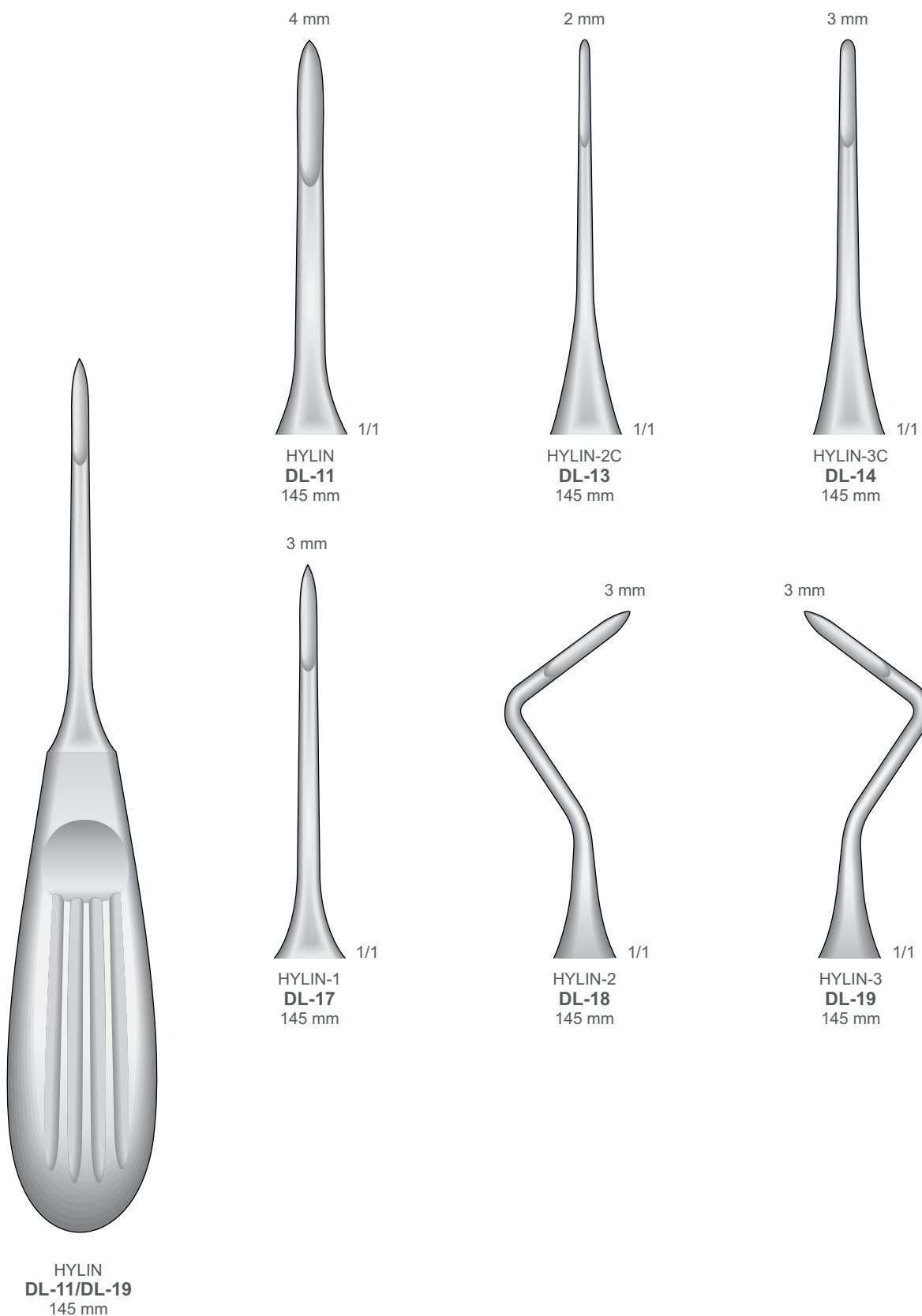

Root Elevators

Wurzelheber

Leve per radici

Elevadores para raíces

Elevateurs à racines

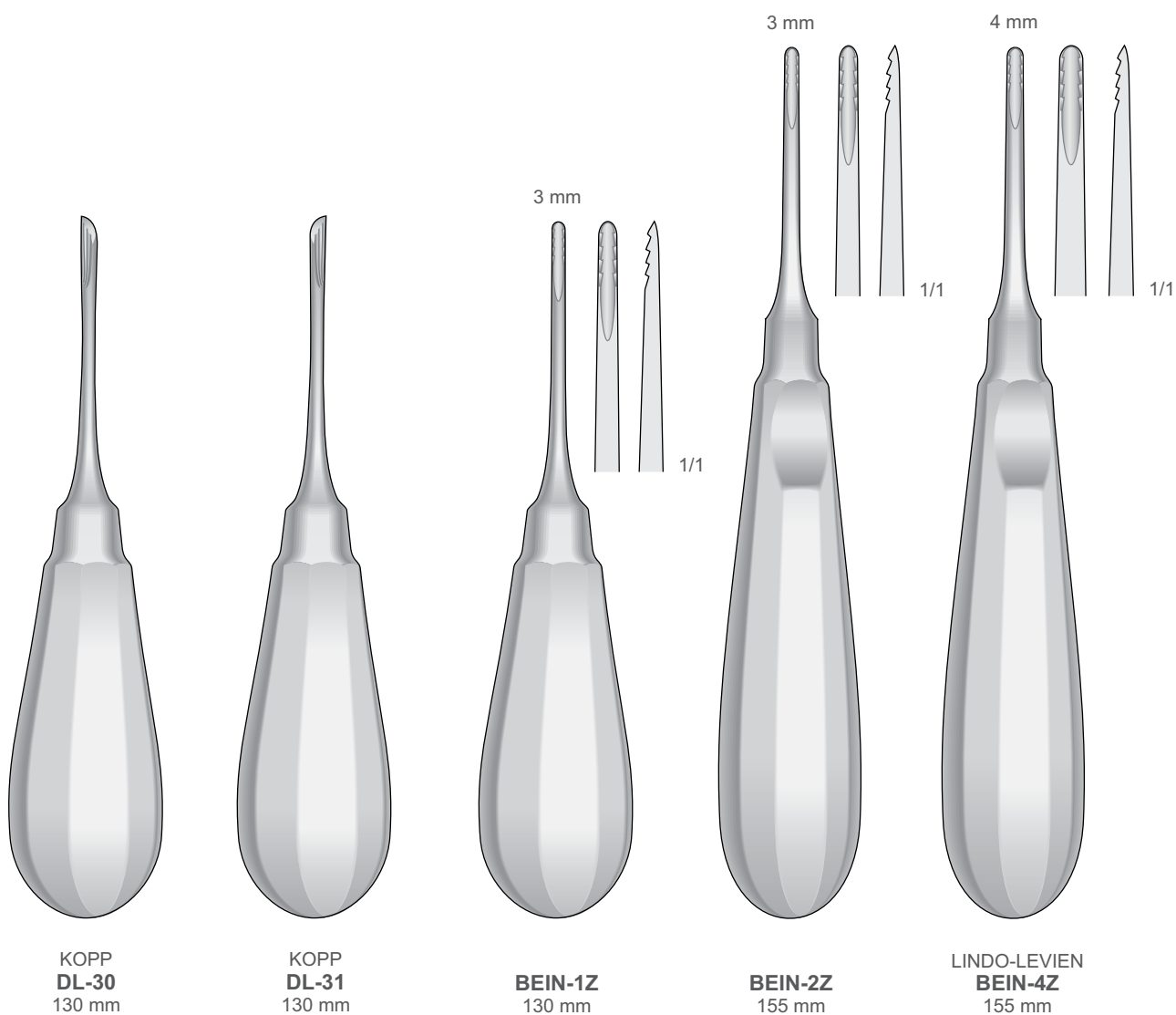

Root Elevators

Wurzelheber
 Leve per radici
 Elevadores para raíces
 Elevateurs à racines

Elevators

Aufzüge
 Ascenseurs
 Ascensori
 Lifty

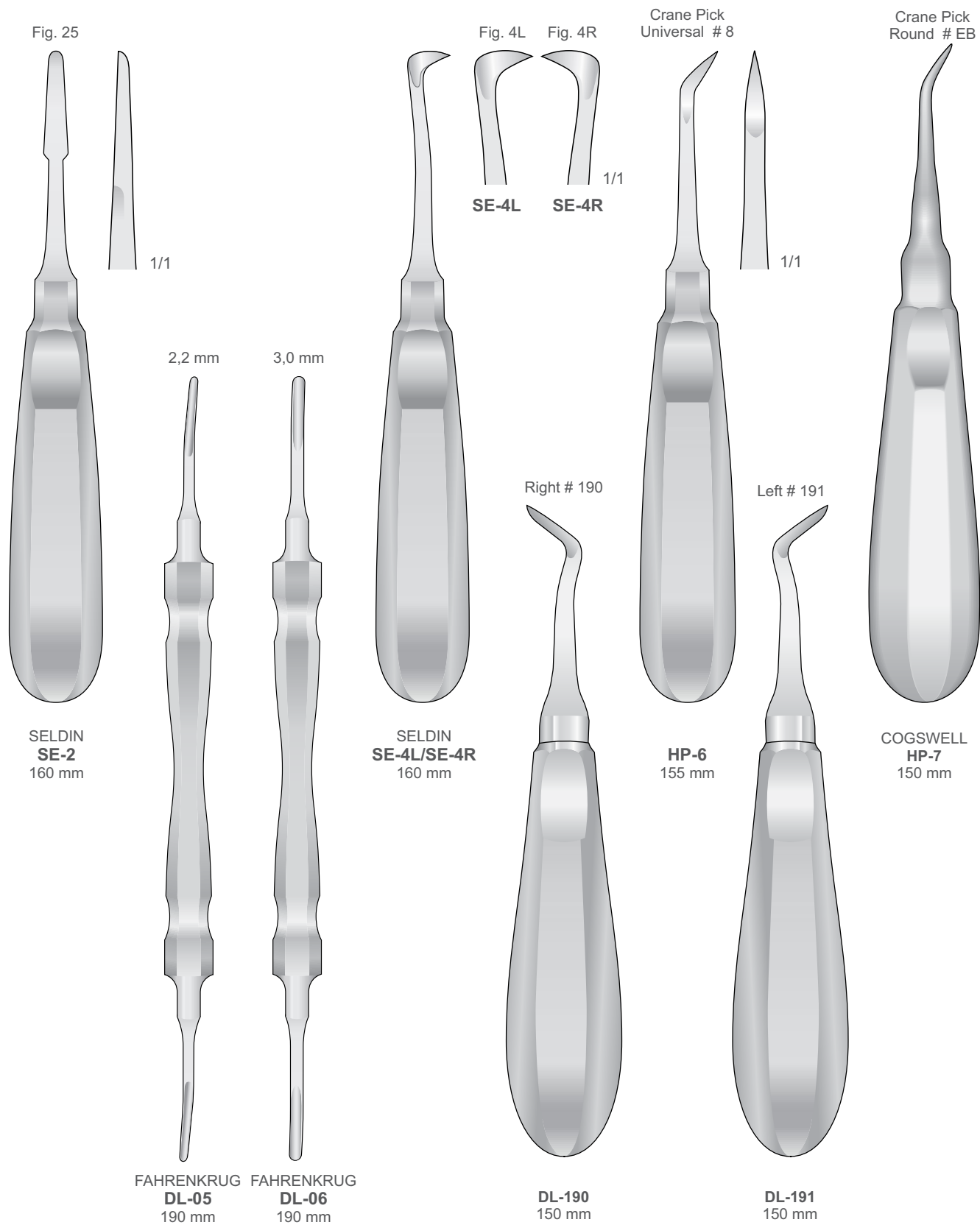

Root Elevators

Wurzelheber
Leve per radici
Elevadores para raíces
Elevateurs à racines

SELDIN
DL-48
304W
155 mm

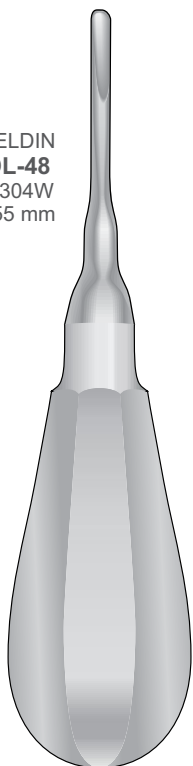

SELDIN
DL-49
34S
155 mm

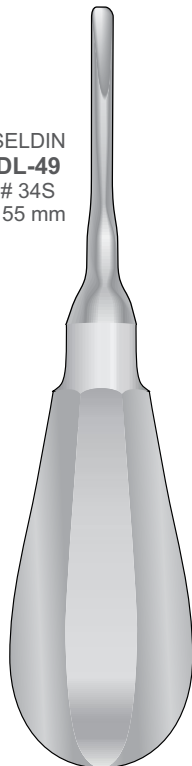

304W

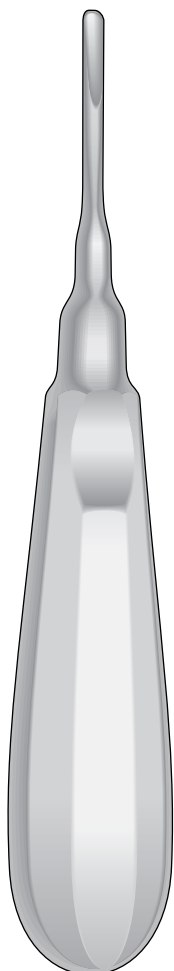

SELDIN
DL-48
304W
155 mm

34S

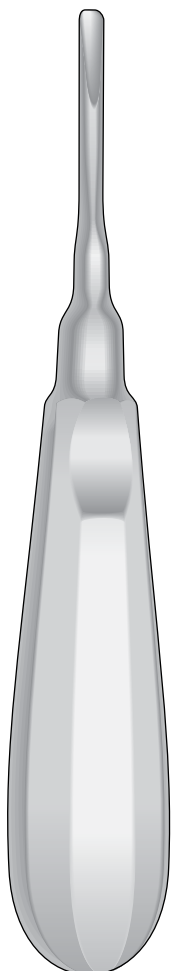

SELDIN
DL-49
34S
155 mm

1/1

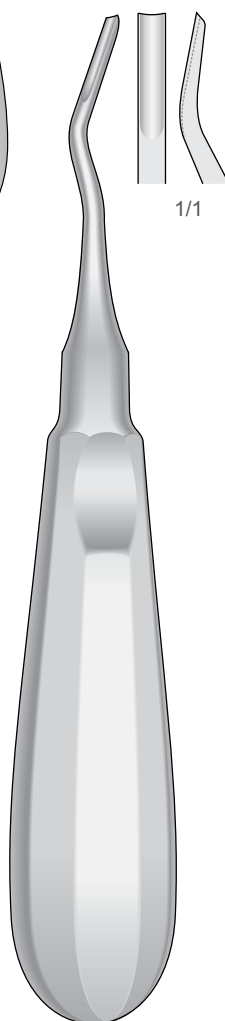

DL-54
160 mm

1/1

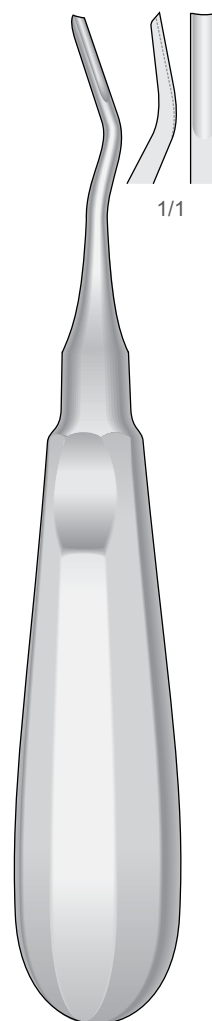

DL-55
160 mm

Root Elevators

Wurzelheber
Leve per radici
Elevadores para raíces
Elevateurs à racines

Elevators

Aufzüge
Ascenseurs
Ascensori
Lifty

Fig. 6

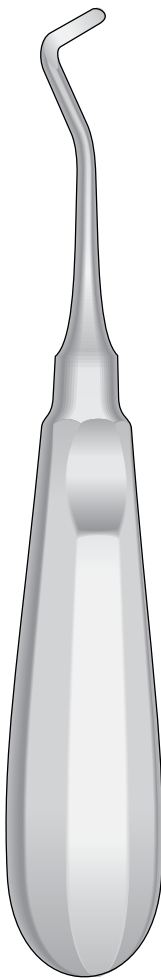

POTT
DL-98
160 mm

Fig. 7

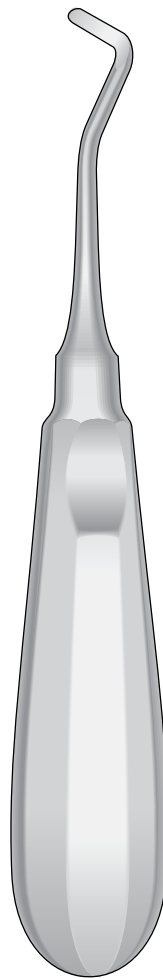

POTT
DL-99
160 mm

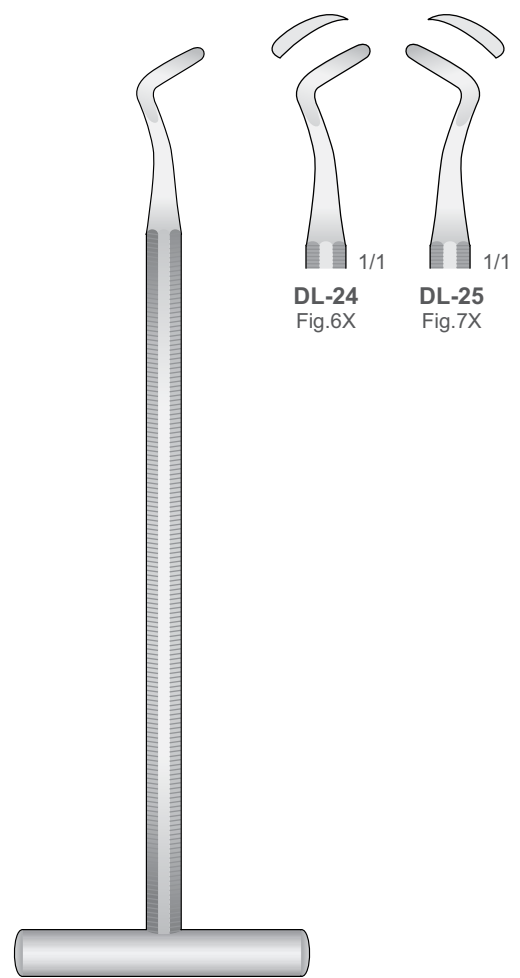

POTT
DL-24/DL-25
155 mm

Root Elevators

Wurzelheber
Leve per radici
Elevadores para raíces
Elevateurs à racines

Syndesmotome
Syndesmotomes
Sindesmotomi
Syndesmôtomos
Syndesmotomos

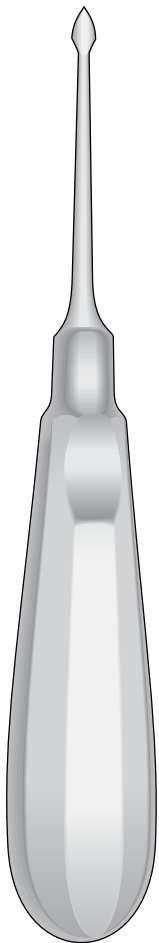

BERNARD
DL-73/DL-124

Gerade
Straight
Diritto
Rectas
Droites

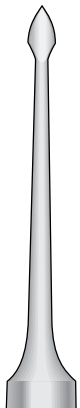

BERNARD
DL-73
150 mm

Links
Left
Sinistra
A la izquierda
À gauche

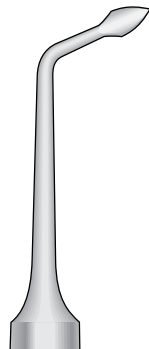

BERNARD
DL-74
140 mm

Rechts
Right
Destro
A la derecha
À droite

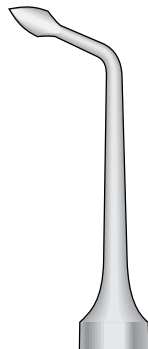

BERNARD
DL-75
140 mm

Bajonett - Bayonet
Baionetta - Bayoneta
Baionnette

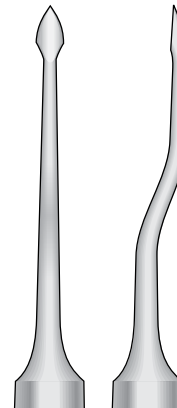

BERNARD
DL-123
150 mm

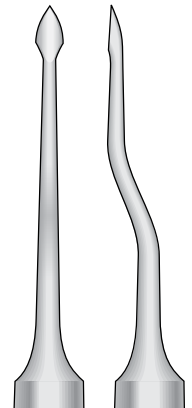

BERNARD
DL-124
150 mm

Root Elevators

Wurzelheber
 Leve per radici
 Elevadores para raíces
 Elevateurs à racines

Elevators

Aufzüge
 Ascenseurs
 Ascensori
 Lifty

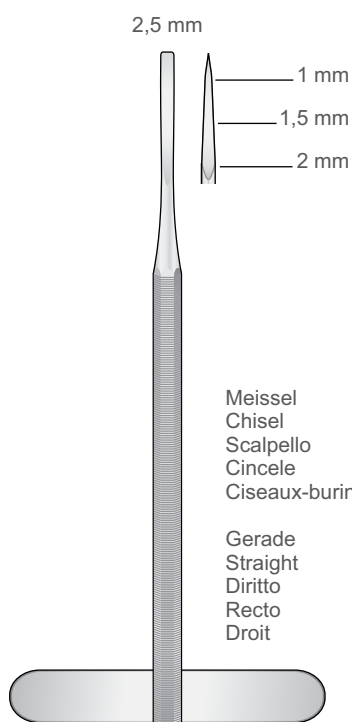

DL-88
130 mm

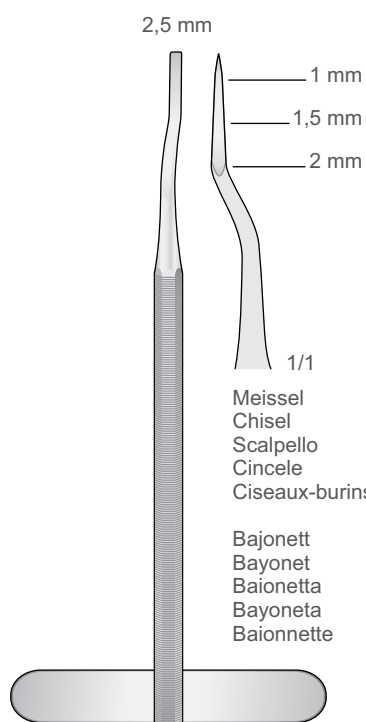

DL-89
130 mm

Root Elevators
 Leve per radici
 Elevadores para raíces
 Elevateurs à racines

Syndesmotome
 Syndesmotomes
 Sindesmotomo
 Syndesmòtomos
 Syndesmotomes

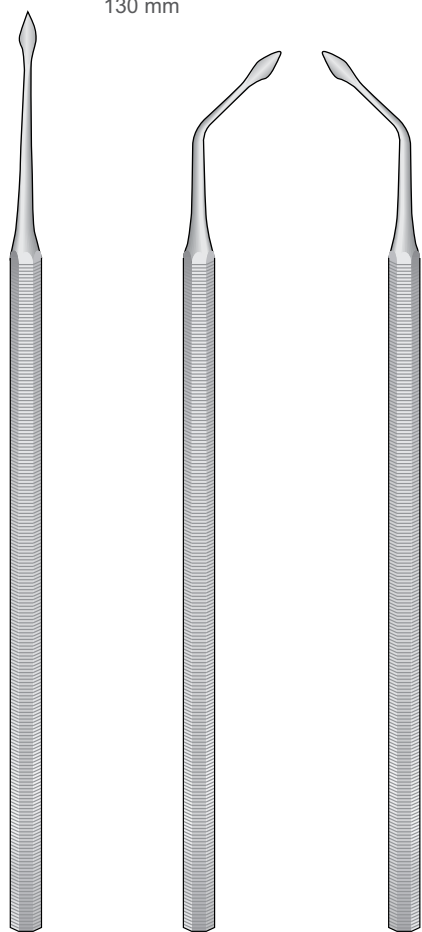

DL-63

DL-62

DL-61

Raspatorien
 Raspatories
 Scollaperiosteo
 Legras
 Rugines

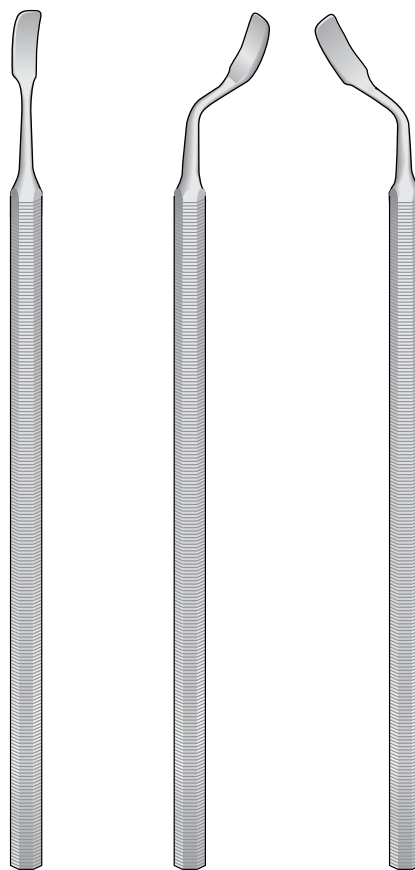

DL-59

DL-68

DL-69

Root Elevators

Wurzelheber
Leve per radici
Elevadores para raíces
Elevateurs à racines

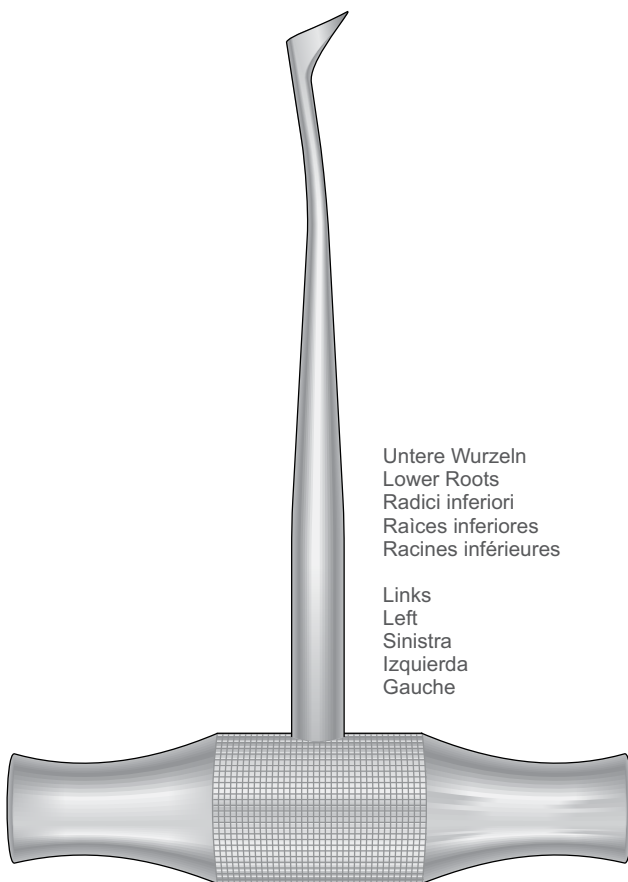

WINTER
DL-100
Fig.1

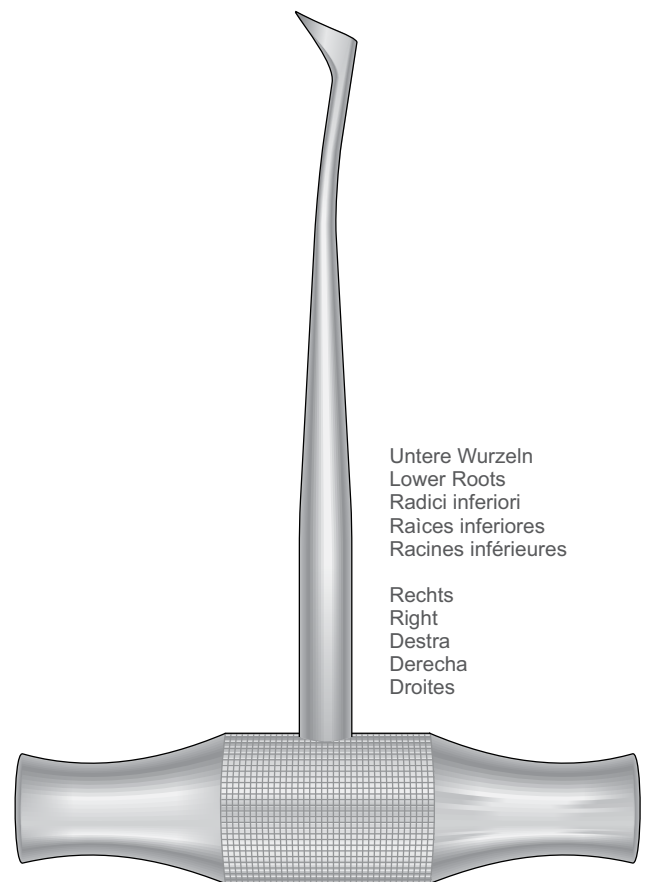

WINTER
DL-101
Fig.2

Root Elevators

Wurzelheber
Leve per radici
Elevadores para raíces
Elevateurs à racines

Elevators

Aufzüge
Ascenseurs
Ascensori
Lifty

Fig. 1L

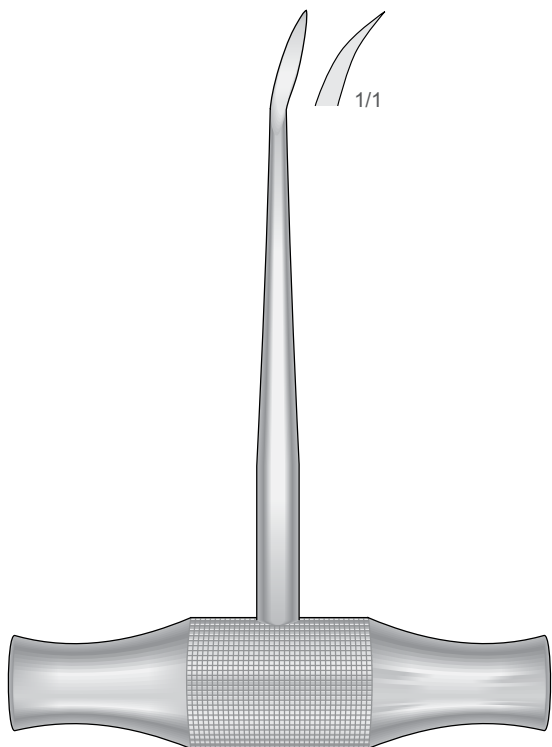

WINTER
DL-64
120 mm

Fig. 1R

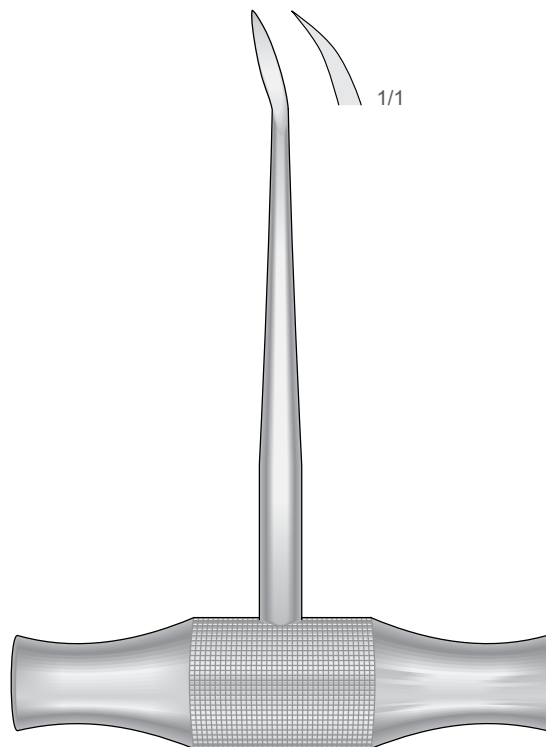

WINTER
DL-65
120 mm

Fig. 14L



WINTER
DL-66
125 mm

Fig. 14R

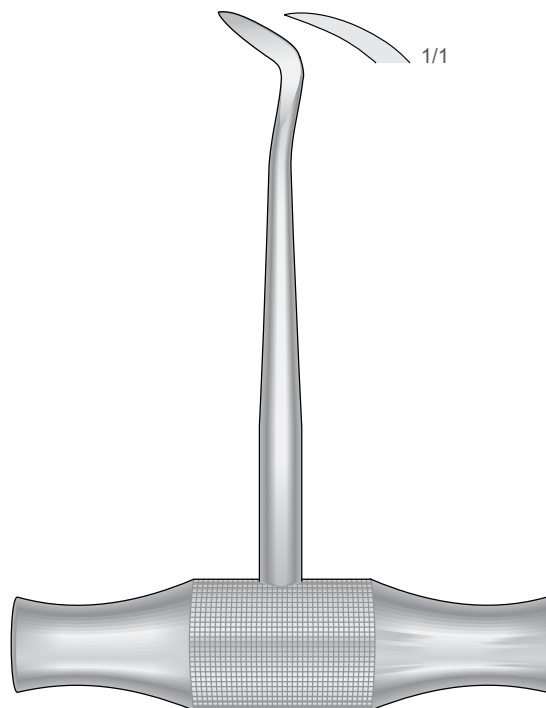

WINTER
DL-67
125 mm

Root Elevators

Wurzelheber
Leve per radici
Elevadores para raíces
Elevateurs à racines

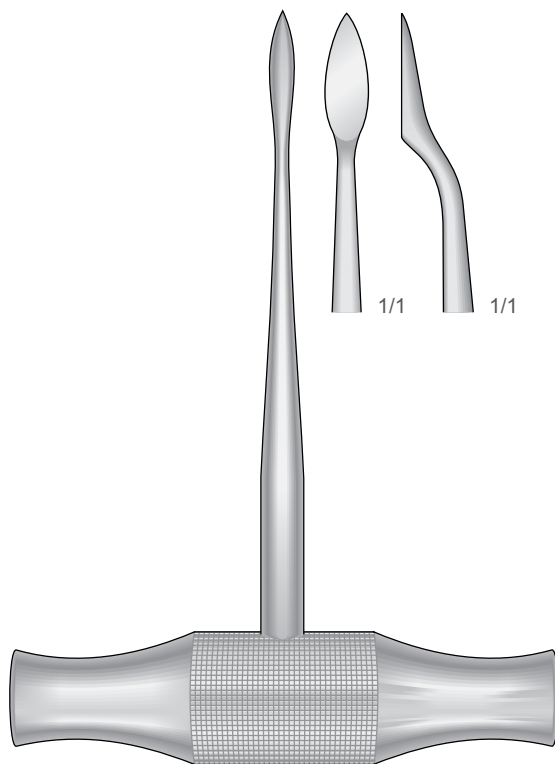

LECLUSE
DL-90
130 mm

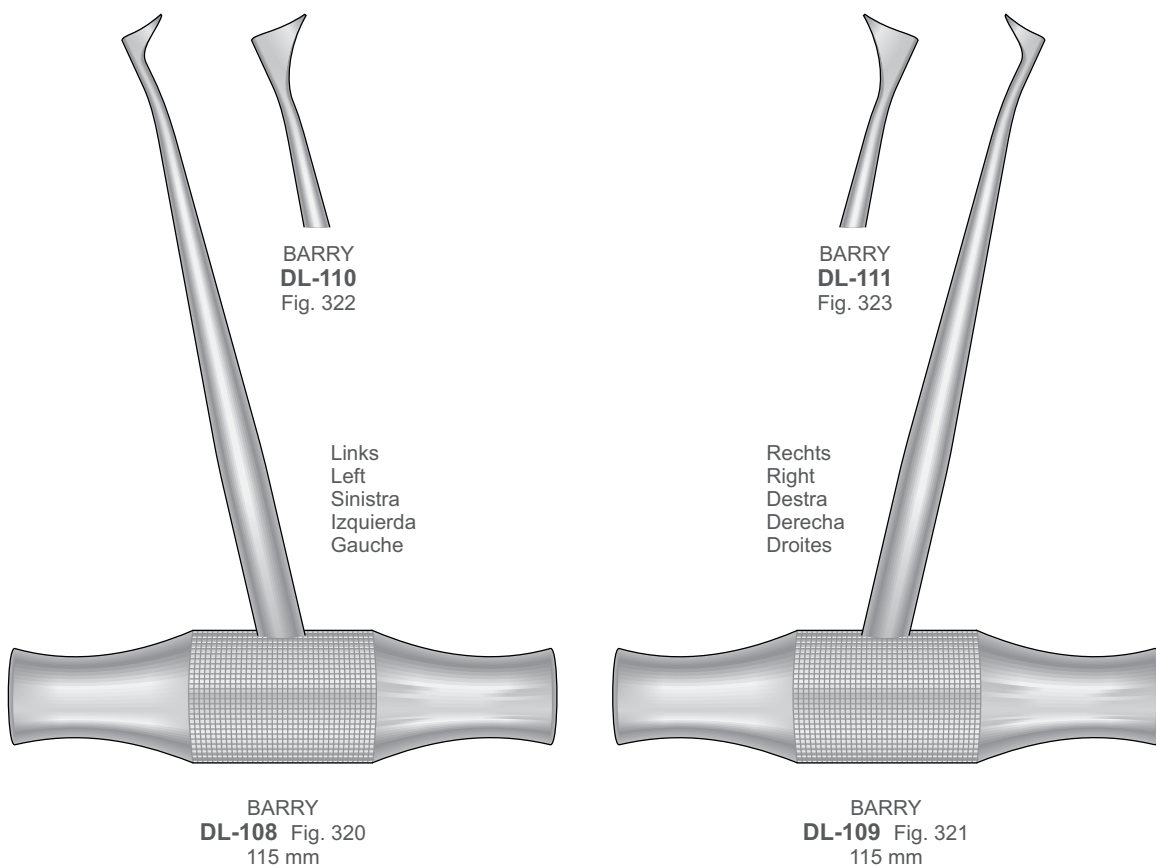

Root Elevators

Wurzelheber
Leve per radici
Elevadores para raíces
Elevateurs à racines

Elevators

Aufzüge
Ascenseurs
Ascensori
Lifty

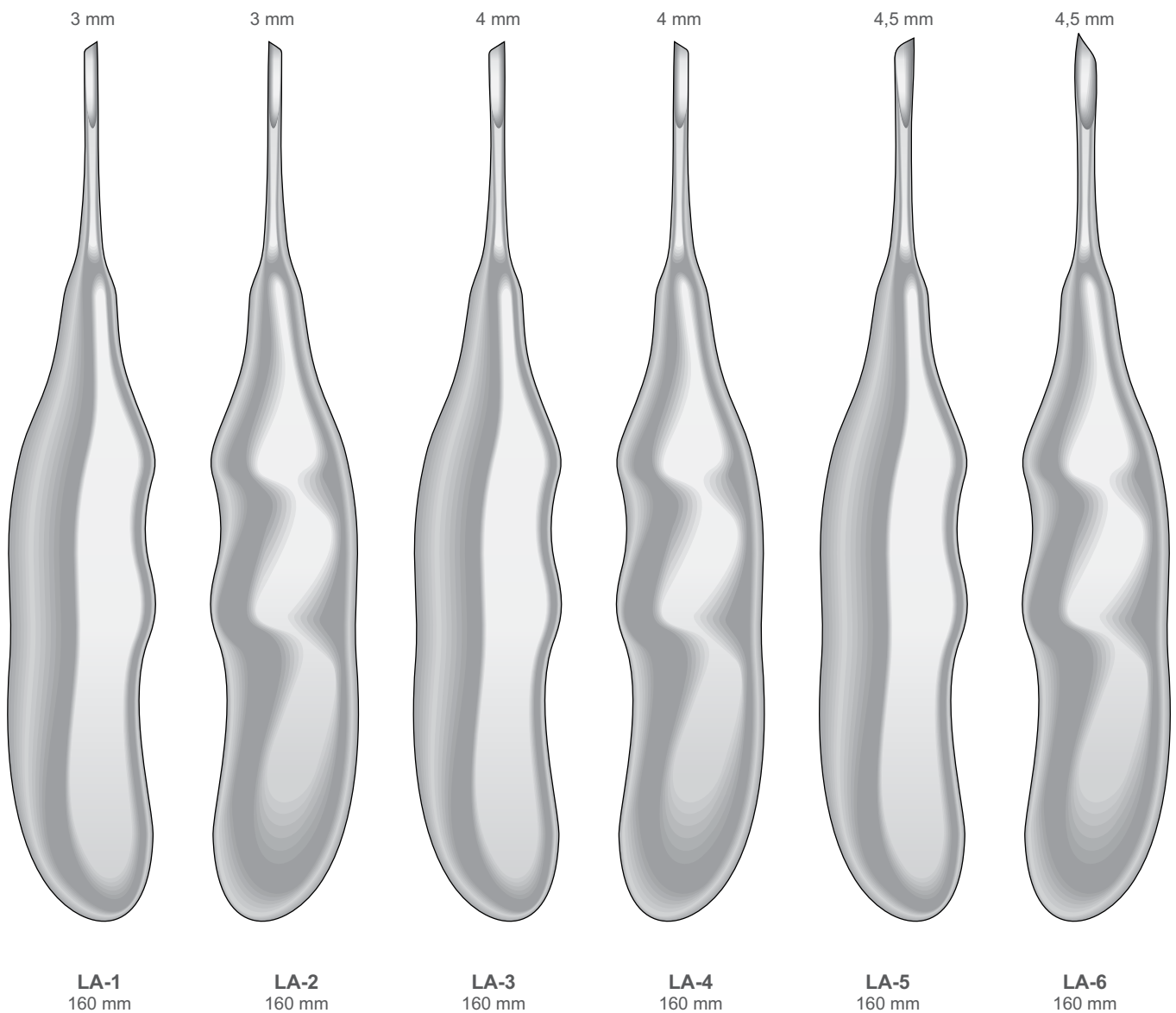

Root Elevators

Wurzelheber

Leve per radici

Elevadores para raíces

Elevateurs à racines



LA-7
160 mm



LA-8
160 mm



LA-9
160 mm



LA-10
160 mm

Root Elevators

Wurzelheber
Leve per radici
Elevadores para raíces
Elevateurs à racines

Elevators

Aufzüge
Ascenseurs
Ascensori
Lifty

2 mm



LA-11
155 mm

3 mm



LA-12
155 mm

4 mm



LA-13
155 mm



LA-16
160 mm



LA-17
160 mm

Root Elevators

Wurzelheber

Leve per radici

Elevadores para raíces

Elevateurs à racines



LA-20
160 mm



LA-21
160 mm



LA-22
160 mm



LA-23
160 mm

Syndesmotomes

Syndesmotome
Sindesmotomo
Syndesmòtomos
Syndesmotomes

Elevators

Aufzüge
Ascenseurs
Ascensori
Lifty



Massiv
Solid
Manico
Pieno
Massif

CHOMPRET
CH-11
150 mm



Massiv
Solid
Manico
Pieno
Massif

CHOMPRET
CH-12
150 mm



Massiv
Solid
Manico
Pieno
Massif

CHOMPRET
CH-13
150 mm



Massiv
Solid
Manico
Pieno
Massif

CHOMPRET
CH-14
145 mm



CHOMPRET
CH-1
165 mm

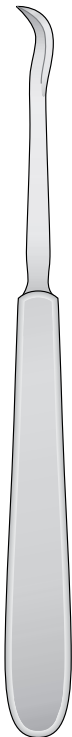

CHOMPRET
CH-2
165 mm



CHOMPRET
CH-3
165 mm



CHOMPRET
CH-4
160 mm

Scalers - Periotomes

Zahnreiniger - Periotome

Ablatori di tartaro - Periotomi

Limpiadores de sarro - Periotomos

Detarteurs - Périotomes

MORSE - SCALERS

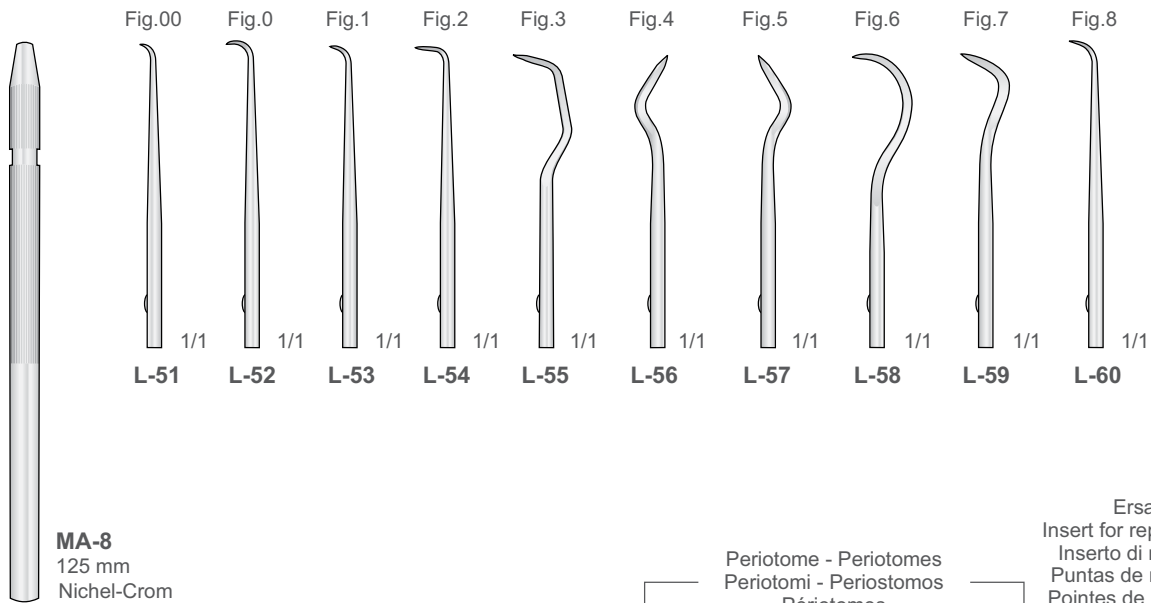

Periotome - Periotomes
Periotomi - Periotomos
Périotomes

Ersatz
Insert for replacement
Inserto di ricambio
Puntas de recambio
Pointes de rechange

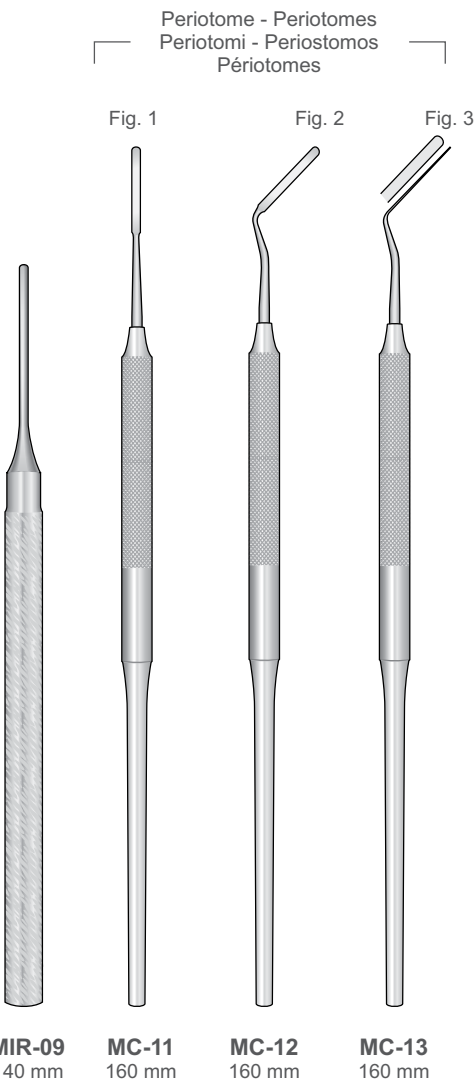

Fig. 1

Fig. 2

Fig. 3

Für / For
Per / Para / Pour
MA-9

L-71

L-72

L-73

MA-9R
48 mm

MA-9
Handle
140 mm
Rostfrei
Stainless Steel
Inox

MC-70
(MA-9 + L-71, L-72, L73)
Komplett mit 1 Griff + 3 Spatel
Complete with 1 Handle + 3 Spatulas
Completo di 1 Manico +3 Spatole
Completo con 1 mango + 3 Espátulas
Complete avec 1 Manche + 3 Spatules

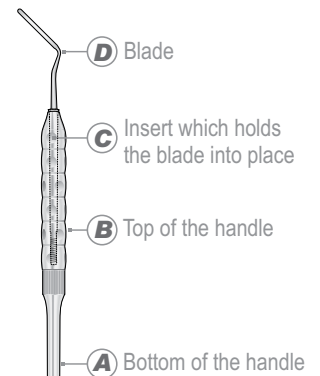

Syndesmotomes

Syndesmotome
Sindesmotomo
Syndesmòtomos
Syndesmotomes

Elevators

Aufzüge
Ascenseurs
Ascensori
Lifty

SDM-C

Komplett mit 2 Griffe + 20 Klingen
Complete with 2 Handles + 20 Blades
Completo di 2 Manici + 20 lame
Completo con 2 mangos + 20 hojas
Complete avec 2 Manches + 20 lames

SD-M

Griff
Handle
Manico
Mango
Manche

SDM-9

Komplett mit 2 Griffe + 9 Klingen APICALI
Complete with 2 Handles + 9 Blades APICALI
Completo di 2 Manici + 9 lame APICALI
Completo con 2 mangos + 9 hojas APICALI
Complete avec 2 Manches + 9 lames APICALI

SDM-11

Komplett mit 2 Griffe + 11 Klingen CERVICALI
Complete with 2 Handles + 11 Blades CERVICALI
Completo di 2 Manici + 11 lame CERVICALI
Completo con 2 mangos + 11 hojas CERVICALI
Complete avec 2 Manches + 11 lames CERVICALI

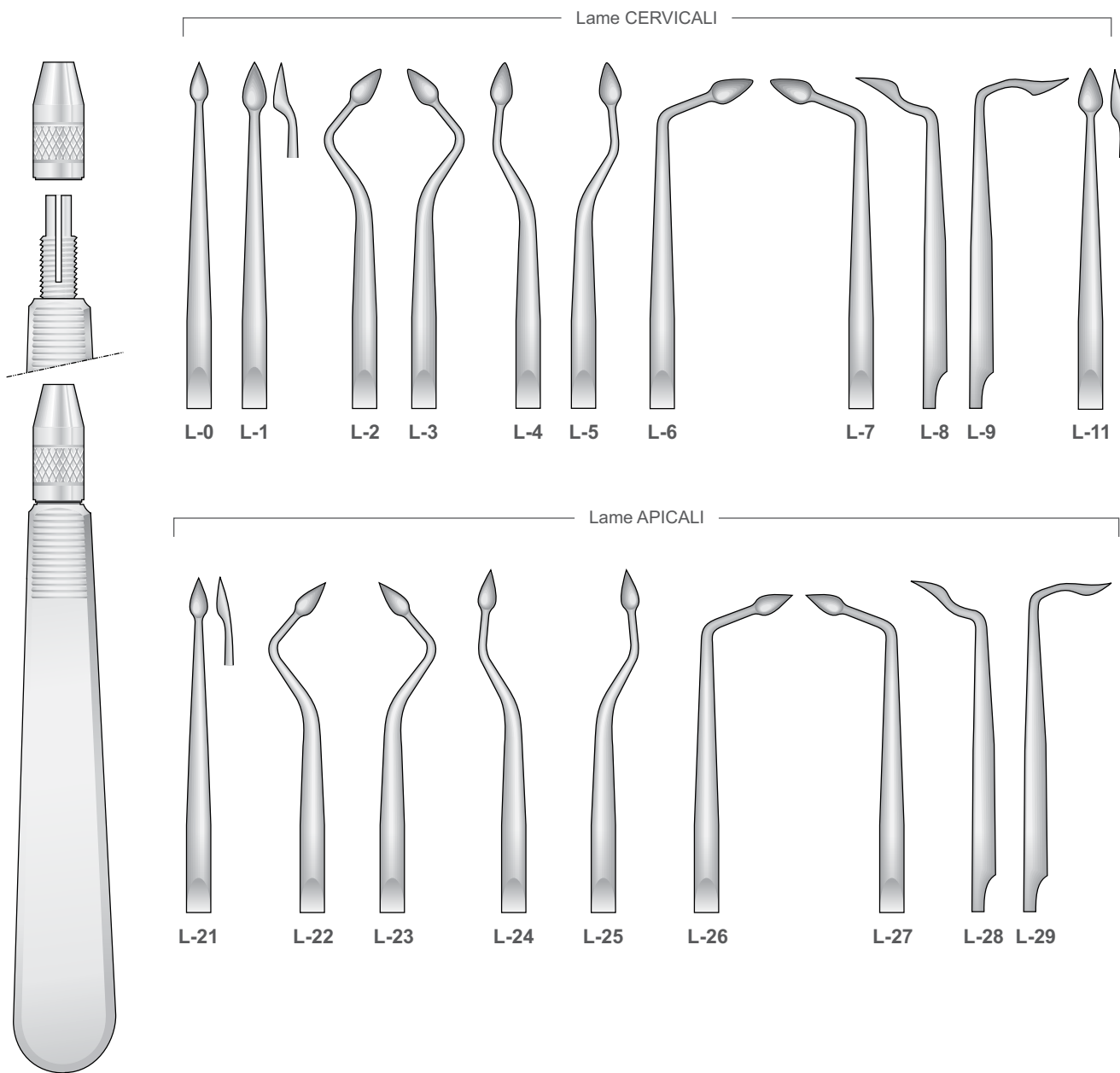

SD-M

MSB

SCALPELS

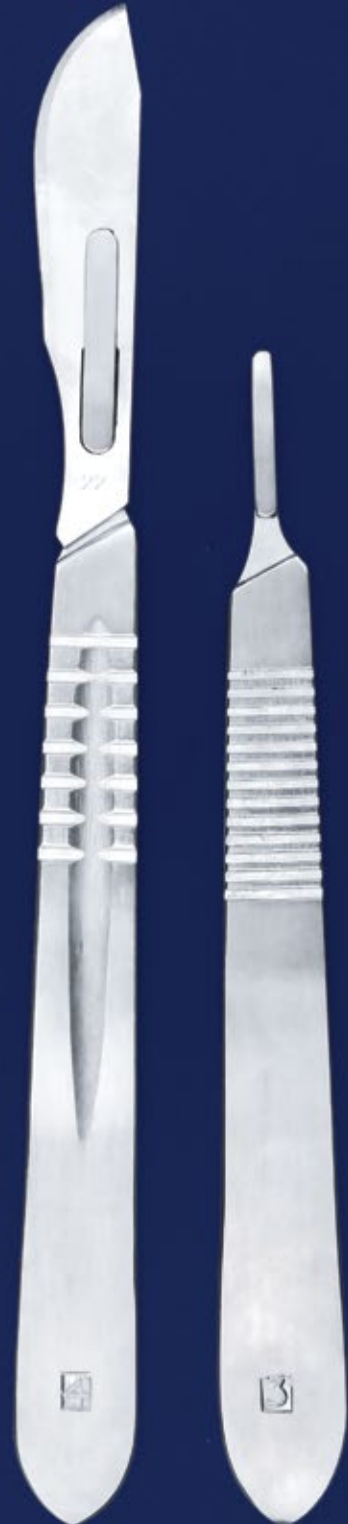

Scalpel Handles - Micro Scalpel Blades

Skalpellgriffe - Mikro Skalpellklingen
 Manici per bisturi - Micro lame per bisturi
 Mangos de bisturí - Micro hojas de bisturí
 Manches pour bistouris - Micro lames de bistouri

Scalpels

Skalpelee
 Bisturies
 Bistouris
 Bisturi

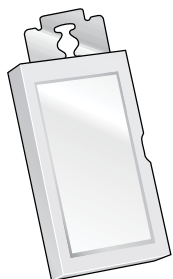

LB-40

Packung 10 Klingen
 Package 10 blades
 Scatola da 10 lame
 Cajita de 10 hojas
 Boite de 10 lames

Skalpellgriffe für Mikro-Klingen
 Skalpel handles for Micro blades
 Manici per micro lame
 Mangos de bisturí para micro hojas
 Manches de bistouris pour micro lames

Micro-Klingen
 Micro blades
 Micro lame
 Micro hojas
 Micro lames

Rasierklingen-Brecker und halter
 Razor blade breaker and holder
 Manico porta lame
 Mango para Hojas de afeitar
 Porte lames à rasoir

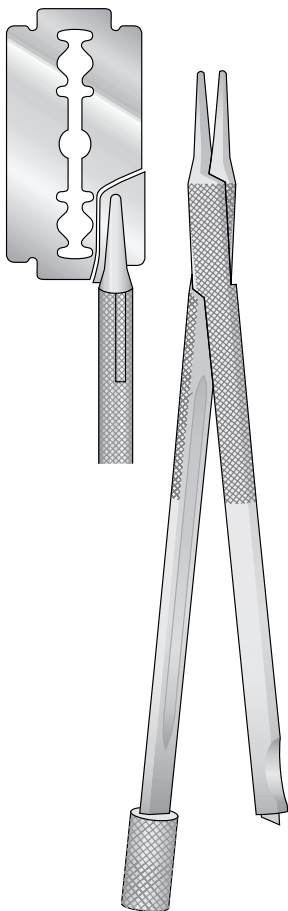

NK-12
120 mm

MA-11
135 mm

BB-46
135 mm

BB-48
155 mm



LB-361
Conf. 10 pz.



LB-362
Conf. 10 pz.



LB-363
Conf. 1 pz.



LB-364
Conf. 10 pz.



LB-365
Conf. 10 pz.

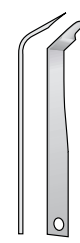

LB-366
Conf. 1 pz.



LB-367
Conf. 10 pz.



LB-368
Conf. 10 pz.



LB-369
Conf. 1 pz.

Scalpel Handles

Skalpellgriffe
Manici porta lame
Mangos de bisturí
Manches de bistouri

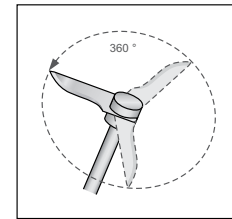

Für Mikro-Klingen
For Micro Blades
Per micro lame
Para micro Hojas
Pour Micro-Lame de bistouris



NK-1
100 mm



NK-3
130 mm



NK-2
150 mm

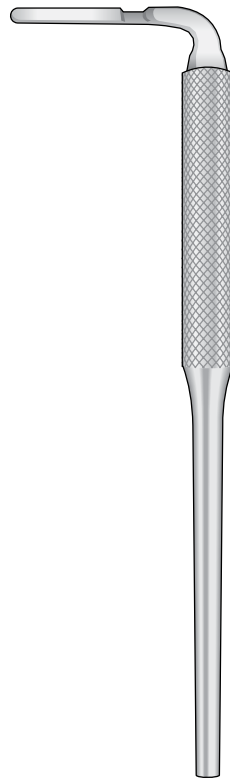

MA-B16
120 mm

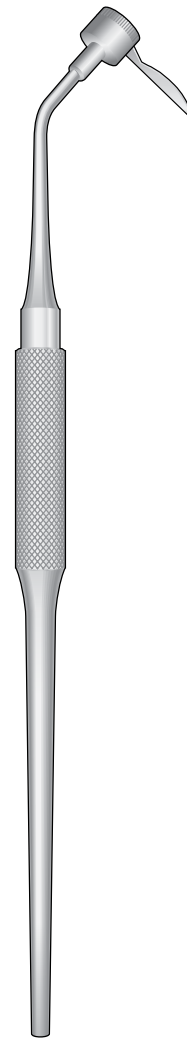

GB-4
165 mm

Scalpel Blades and Handle

Skalpelle und Skalpellgriffe
Lame e manici per bisturi
Hojas y mangos de bisturí
Lames et manches de bistouri

Scalpels

Skalpelee
Bisturies
Bistouris
Bisturi

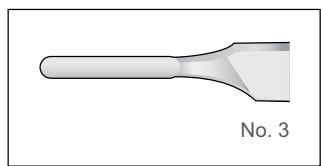

Packungen à 100
Packages of 100 ea
Scatole da 100 pezzi
Cajas de 100 c/u
Boîtes de 100 pièces



LB-10
Fig. 10



LB-11
Fig. 11



LB-12
Fig. 12

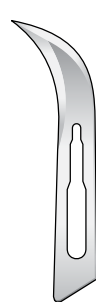

LB-12D
Fig. 12D



LB-13
Fig. 13



LB-15
Fig. 15



LB-15A
Fig. 15A



LB-15C
Fig. 15C



MA-B3



MA-B3M
Fig. 3M



MA-B7



MA-B7K



MA-B1
Fig. 5



MA-B2
Fig. 5A



MA-B8/MA-B9
155 mm

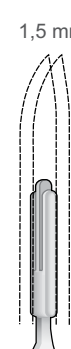

MA-B8

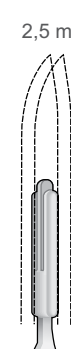

MA-B9

Doppelt Skalpellgriff
Scalpel Handle double Blade
Manico per bisturi a doppia lama
Mango de bisturí doble hojas
Manche pour bistouri double-lames

Scalpel Blades

Skalpelle
Lame per bisturi
Hojas de bisturí
Lames de bistouri

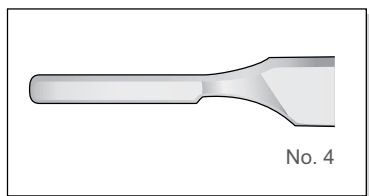

No. 4

Packungen à 100
Packages of 100 ea
Scatole da 100 pezzi
Cajas de 100 c/u
Boîtes de 100 pièces



LB-18
Fig. 18



LB-20
Fig. 20



LB-21
Fig. 21



LB-23
Fig. 23

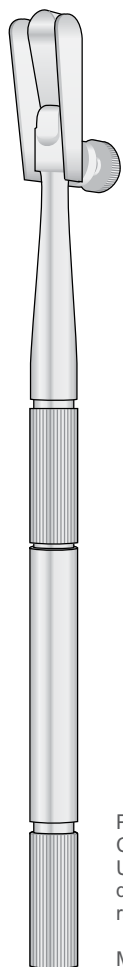

Palatal, Gingival,
Connective Tissue Grafts
Uses standard
double-edged
razor blade

Mucotomo

**PAQUETTE
BLADE HOLDER**
GB-2
160 mm



MA-B4
Fig. 4

Klingenentfemer
Scalpel blade removing forceps
Pinze togliilama
Pinza para quitar hojas de bisturíes
Pince pour enlever les lames de bistouris

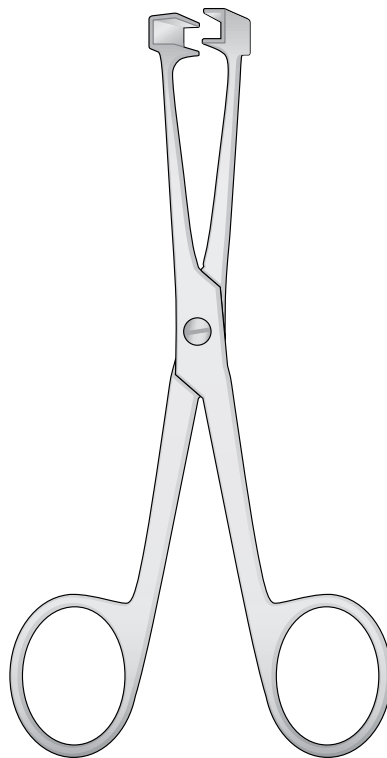

GS-18
135 mm

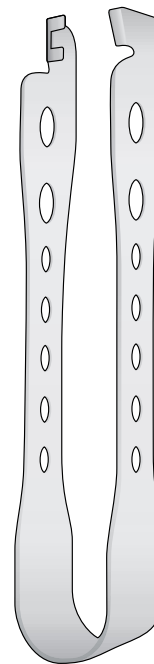

GS-16
115 mm

Knives
 Messer
 Coltelli
 Cuchillos
 Couteaux

Scalpels
 Skalpelee
 Bisturies
 Bistouris
 Bisturi

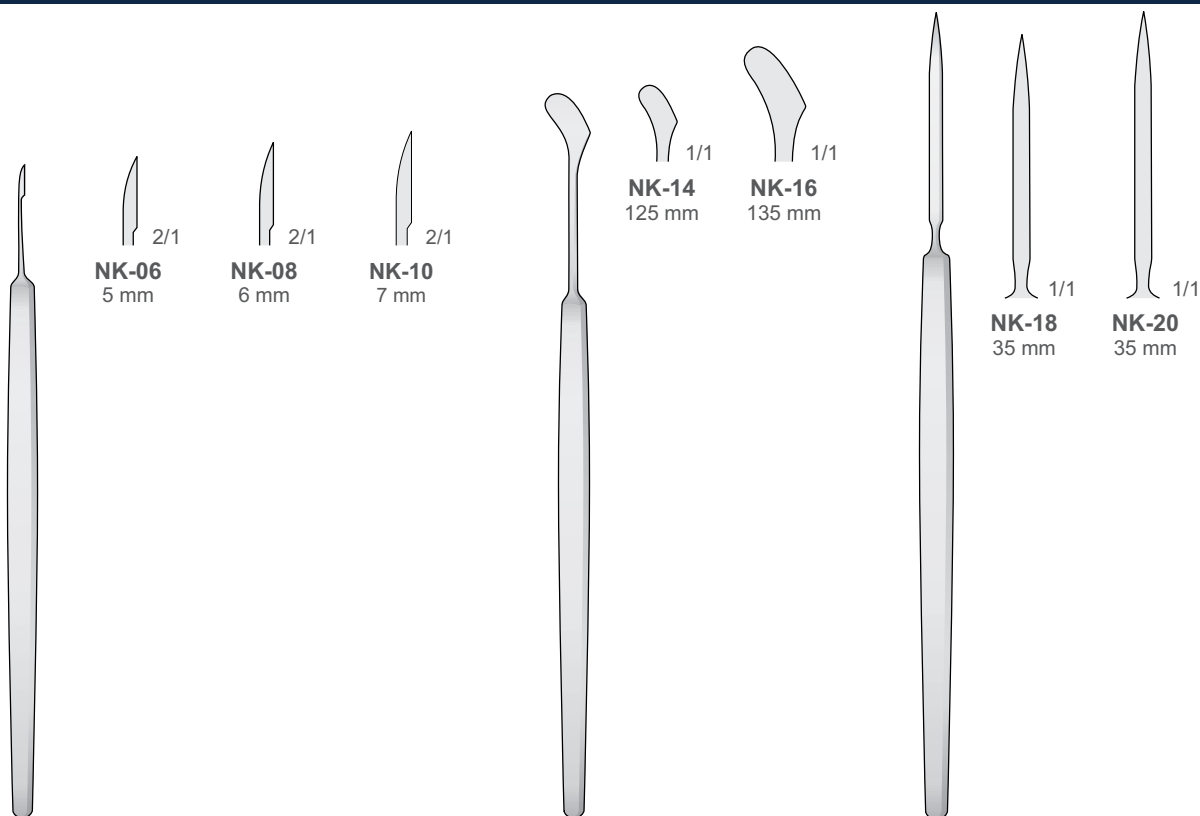

ZIEGLER
NK-06/NK-10
 115 mm

GRAEFE
NK-14/NK-16

GRAEFE
NK-18/NK-20
 140 mm

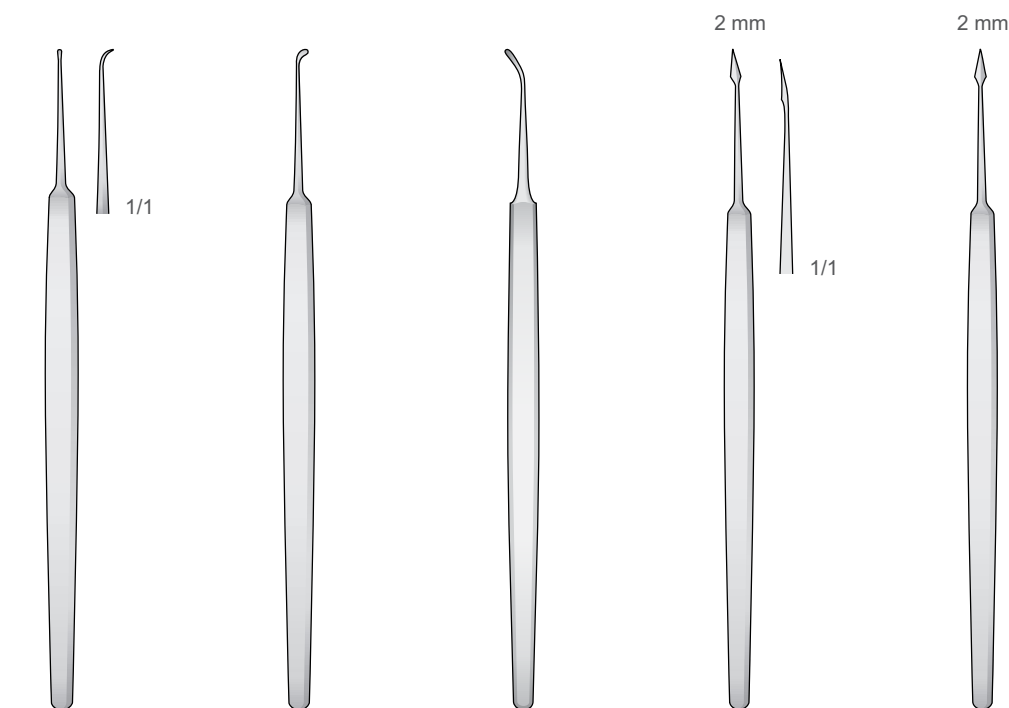

LA FORCE
NK-07
 120 mm

ELLIS
NK-09
 120 mm

NK-11
 125 mm

NK-17
 125 mm

NK-39
 125 mm

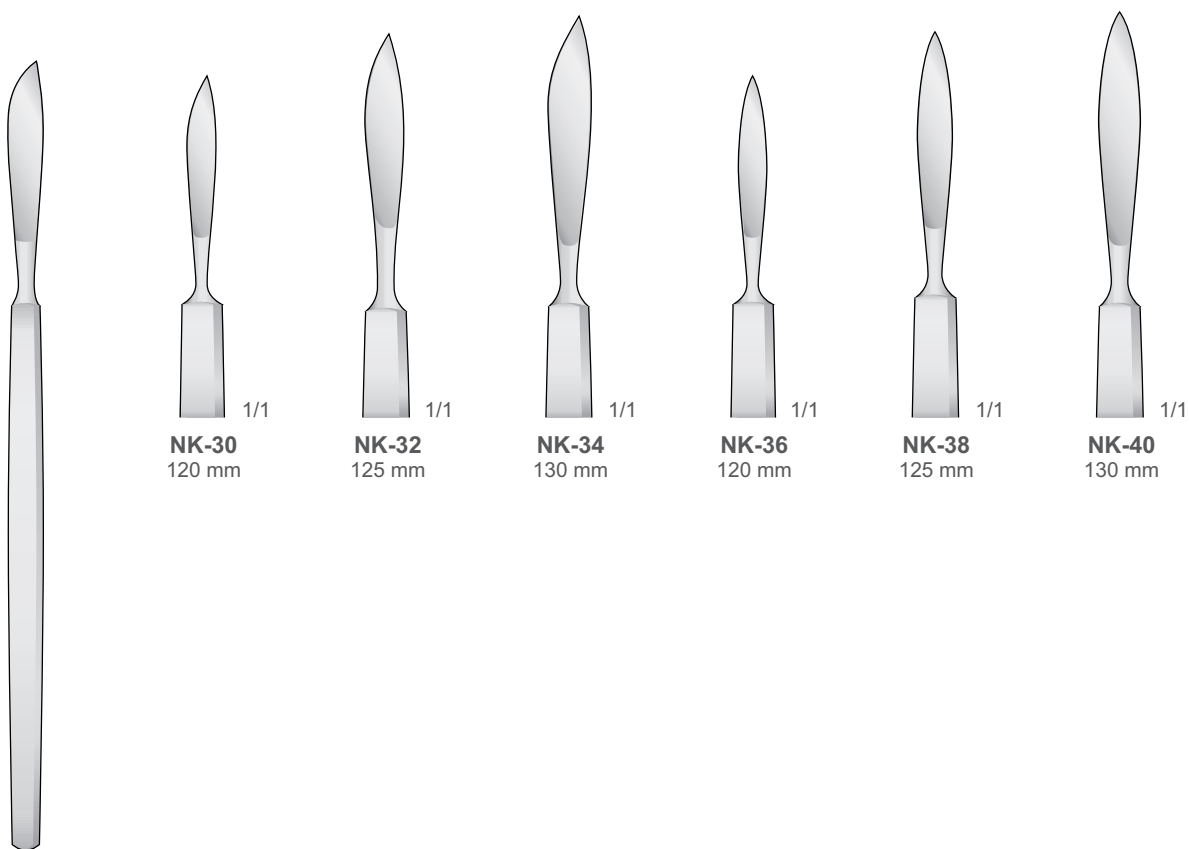

NK-30
120 mm

NK-32
125 mm

NK-34
130 mm

NK-36
120 mm

NK-38
125 mm

NK-40
130 mm

NK-30/NK-40

MSB

SCISSORS



Micro Scissors

Mikro-Scheren
 Micro Forbici
 Micro Tijeras
 Micro Ciseaux

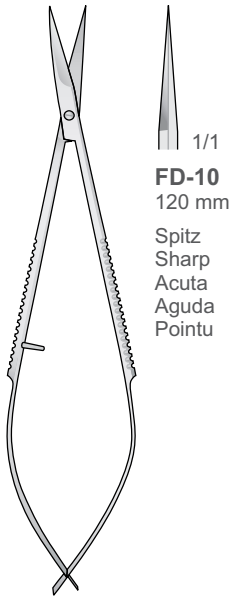

1/1
FD-10
 120 mm
 Spitz
 Sharp
 Acuta
 Aguda
 Pointu

NOYES
FD-10
 120 mm

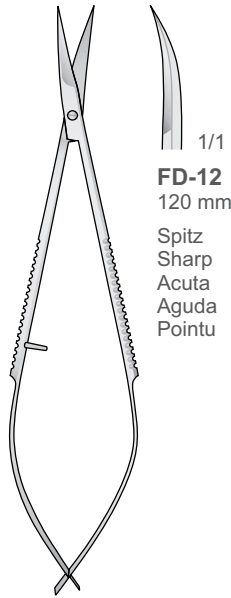

1/1
FD-12
 120 mm
 Spitz
 Sharp
 Acuta
 Aguda
 Pointu

NOYES
FD-12
 120 mm

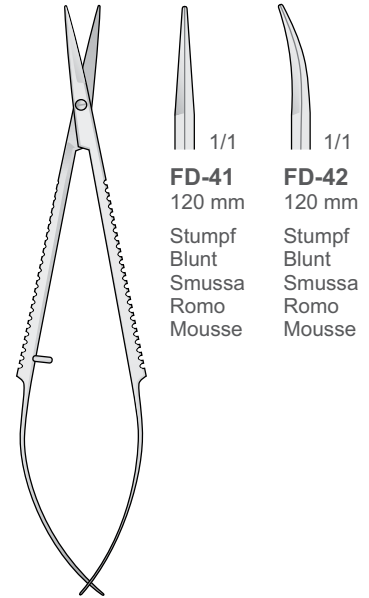

1/1 1/1
FD-41 **FD-42**
 120 mm 120 mm
 Stumpf
 Blunt
 Smussa
 Romo
 Mousse

FD-41/FD-42
 120 mm

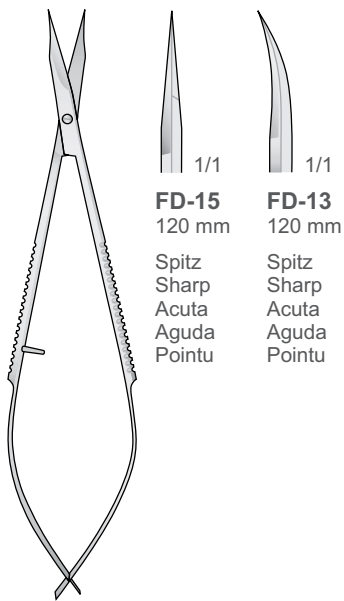

1/1 1/1
FD-15 **FD-13**
 120 mm 120 mm
 Spitz
 Sharp
 Acuta
 Aguda
 Pointu

WESTCOTT
FD-13/FD-15
 120 mm

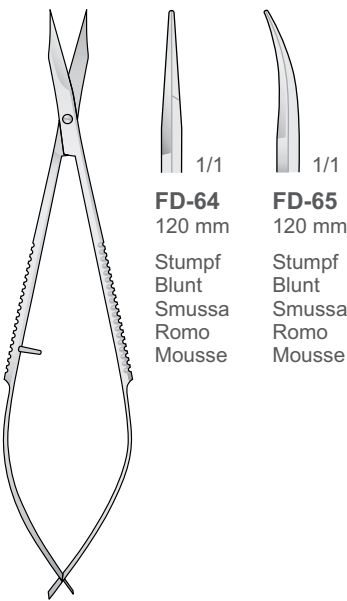

1/1 1/1
FD-64 **FD-65**
 120 mm 120 mm
 Stumpf
 Blunt
 Smussa
 Romo
 Mousse

WESTCOTT
FD-64/FD-65
 120 mm

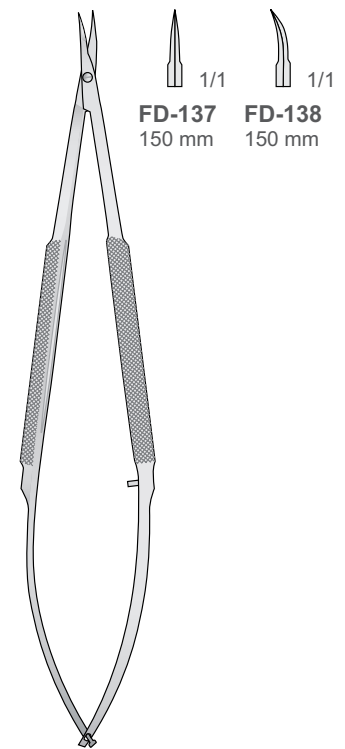

1/1 1/1
FD-137 **FD-138**
 150 mm 150 mm

FD-137/FD-138
 150 mm

Scissors

Scheren
Forbici
Tijeras
Ciseaux

Scissors

Scheren
Forbici
Tijeras
Ciseaux

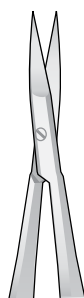
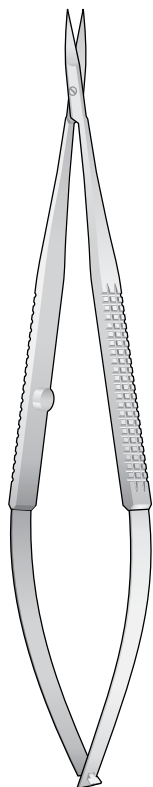

FD-182
160 mm
Spitz
Sharp
Acuta
Aguda
Pointu

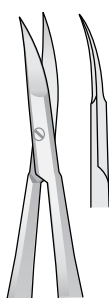

FD-183
160 mm
Spitz
Sharp
Acuta
Aguda
Pointu

1/1

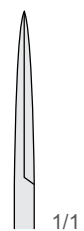
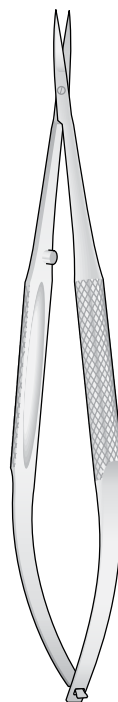

FD-224
145 mm
Spitz
Sharp
Acuta
Aguda
Pointu

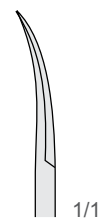

FD-225
145 mm
Spitz
Sharp
Acuta
Aguda
Pointu

1/1

1/1

FD-182/FD-183
160 mm

FD-224/FD-225
145 mm

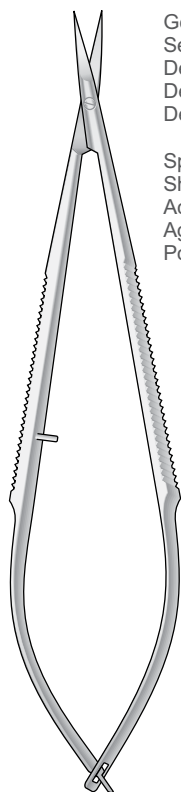

Gezahnt
Serrated
Dentellata
Dentada
Dentelé

Spitz
Sharp
Acuta
Aguda
Pointu

FD-145
160 mm

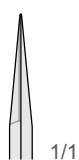
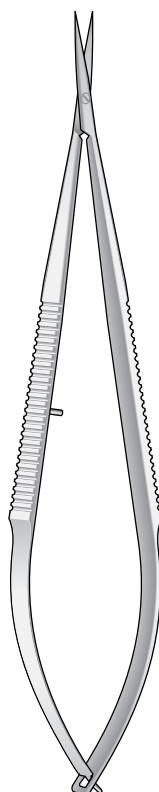

FD-06
160 mm
Spitz
Sharp
Acuta
Aguda
Pointu

FD-06
160 mm

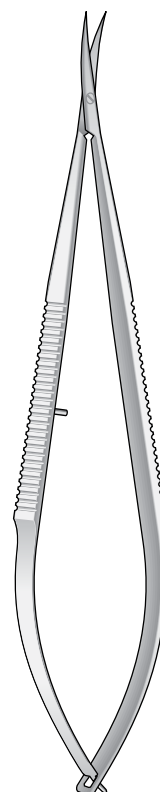

FD-08
160 mm
Spitz
Sharp
Acuta
Aguda
Pointu

FD-08
160 mm

Scissors

Scheren
Forbici
Tijeras
Ciseaux

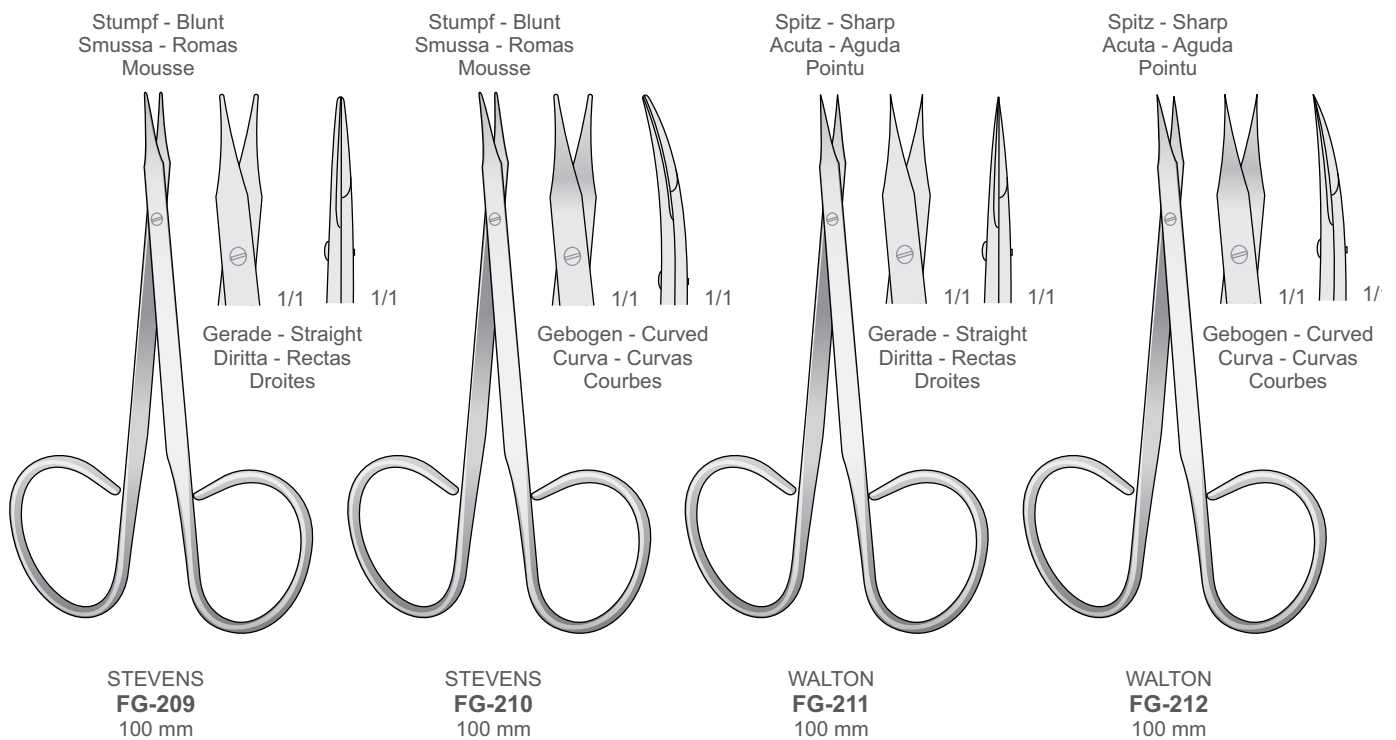
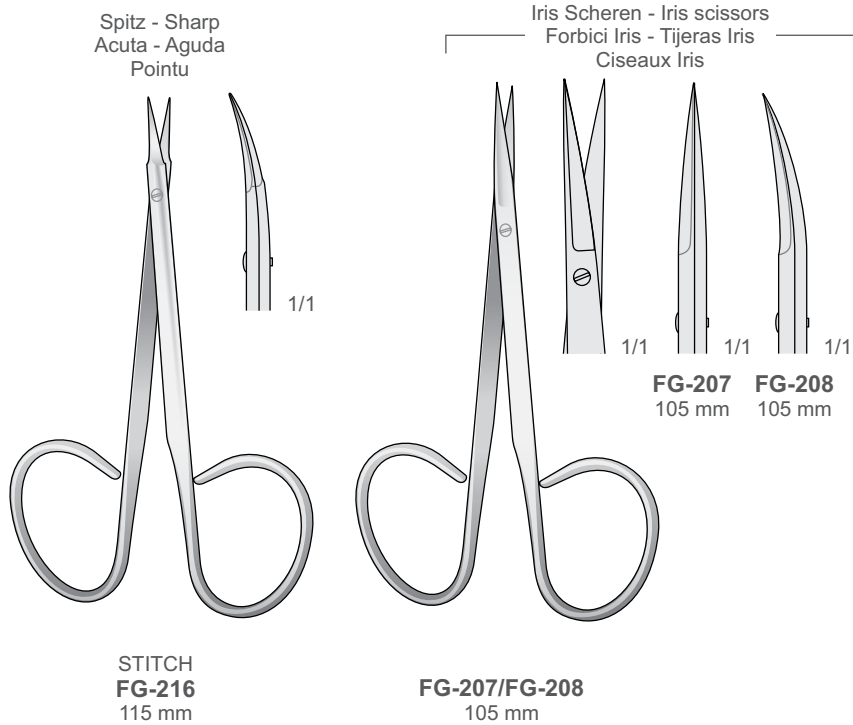

Scissors

Scheren
Forbici
Tijeras
Ciseaux

Scissors

Scheren
Forbici
Tijeras
Ciseaux

L = links
left
mancini
izquierdo
gauche

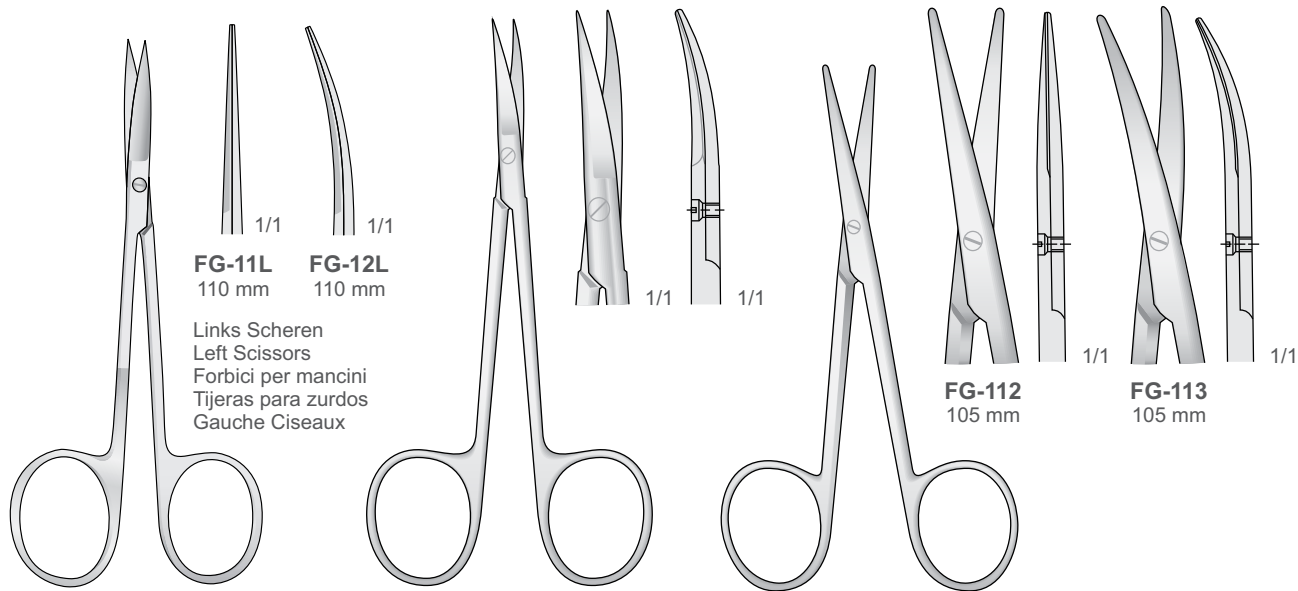

FG-11L 110 mm
FG-12L 110 mm

Links Scheren
Left Scissors
Forbici per mancini
Tijeras para zurdos
Gauche Ciseaux

FG-112
105 mm

FG-113
105 mm

IRIS
FG-11L/FG-12L
110 mm

COTTLE
FG-59
115 mm

COTTLE-KNAPP
FG-112/FG-113
105 mm

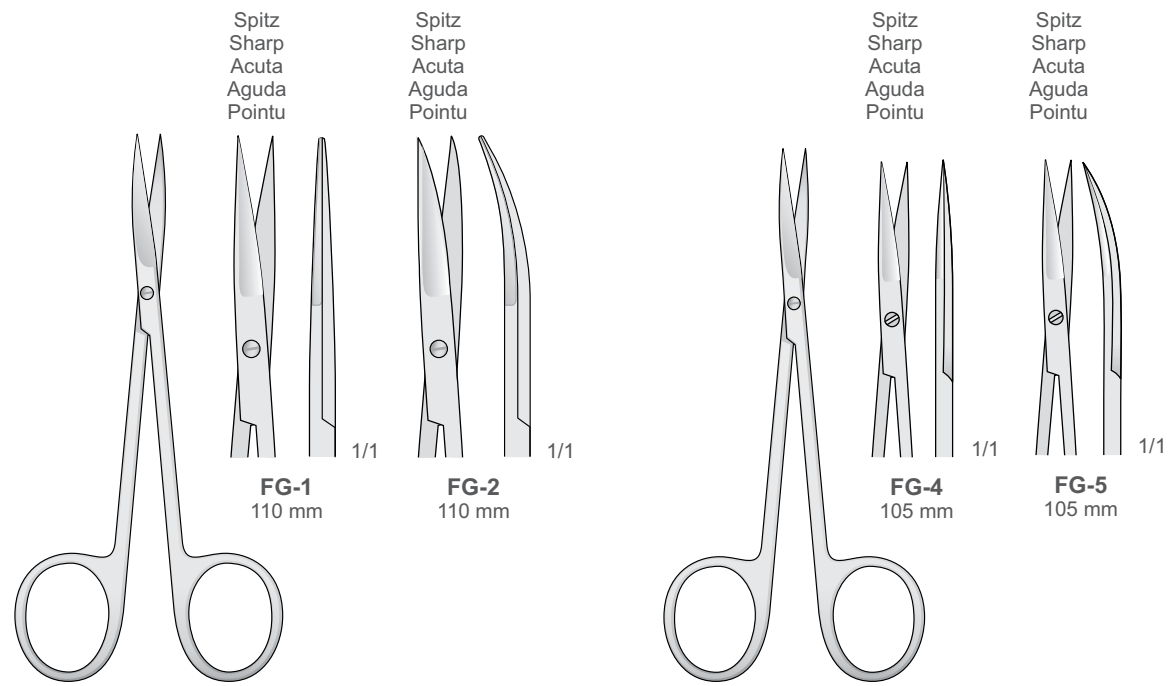

Spitz
Sharp
Acuta
Aguda
Pointu

Spitz
Sharp
Acuta
Aguda
Pointu

Spitz
Sharp
Acuta
Aguda
Pointu

Spitz
Sharp
Acuta
Aguda
Pointu

FG-1
110 mm

FG-2
110 mm

FG-4
105 mm

FG-5
105 mm

IRIS
FG-1/FG-2
110 mm

FG-4/FG-5
105 mm

Scissors

Scheren
Forbici
Tijeras
Ciseaux

Gezahnt - Serrated
Dentellata - Dentelé - Dentadas

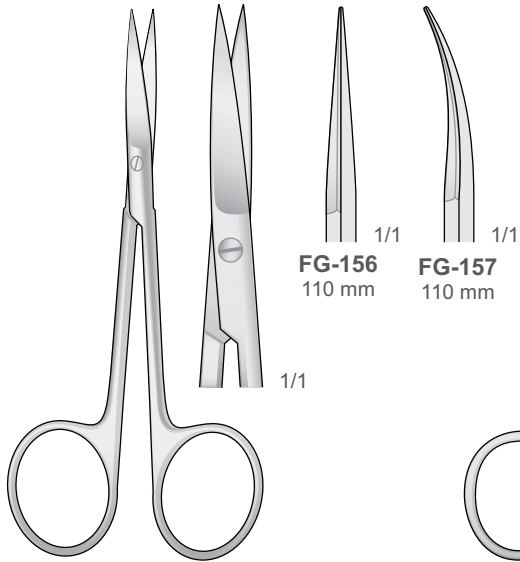

FG-156/FG-157
110 mm

Gezahnt - Serrated
Dentellata - Dentelé - Dentadas

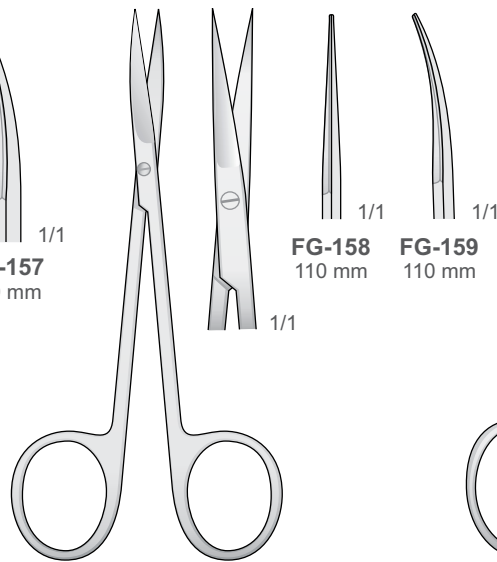

FG-158/FG-159
110 mm

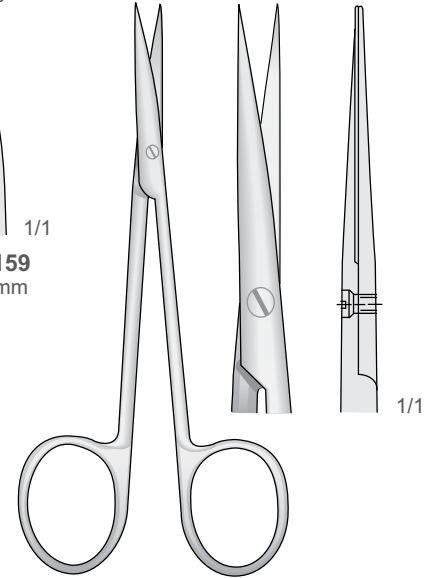

**KILNER
FG-58**
115 mm

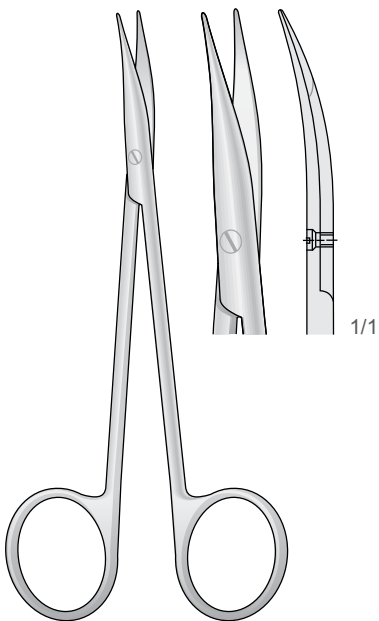

**JAMESON-WERBER
FG-123**
130 mm

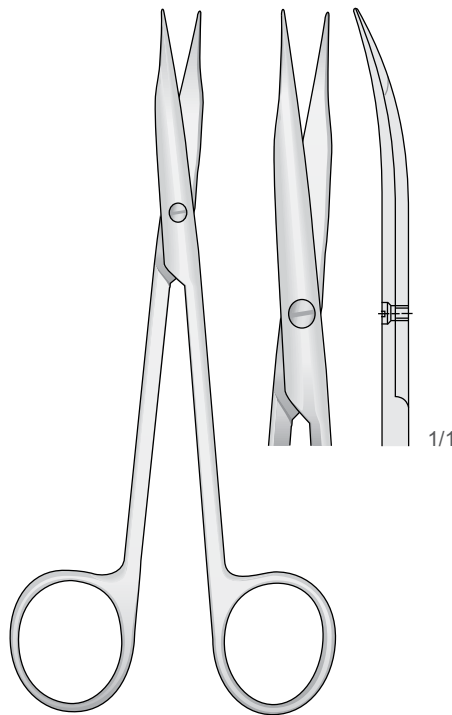

**JAMESON
FG-124**
145 mm

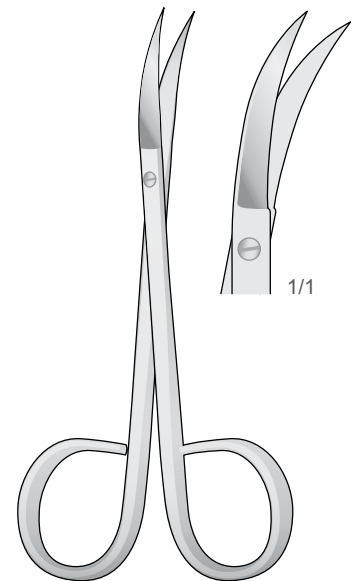

FG-3
115 mm

Scissors

Scheren
Forbici
Tijeras
Ciseaux

Scissors

Scheren
Forbici
Tijeras
Ciseaux

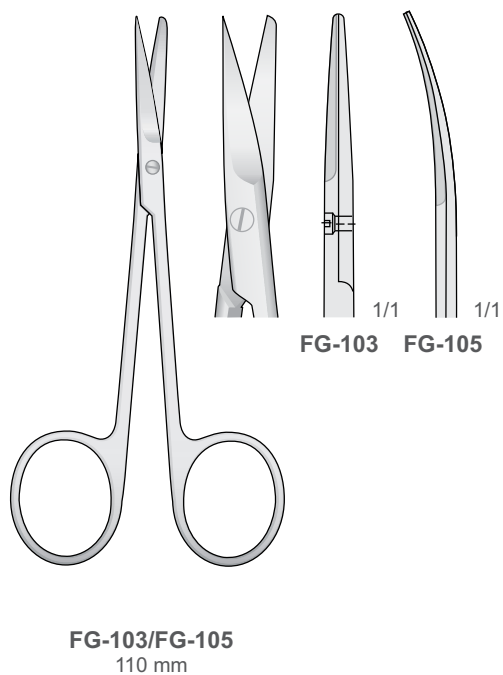
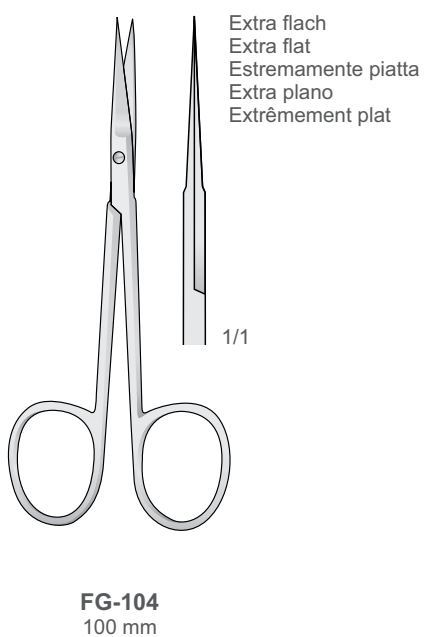
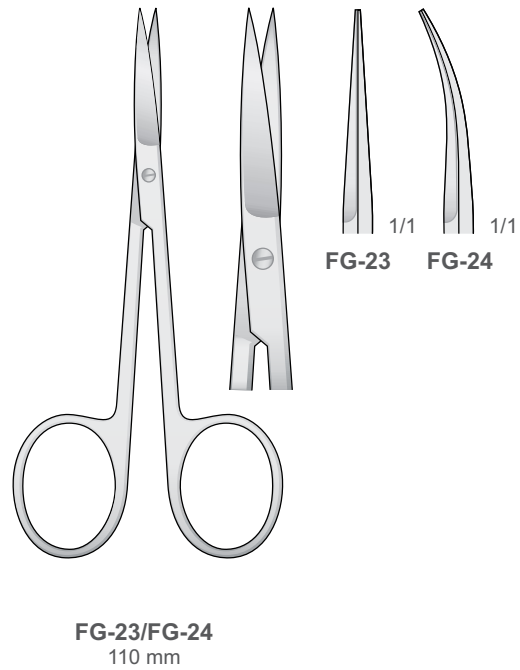
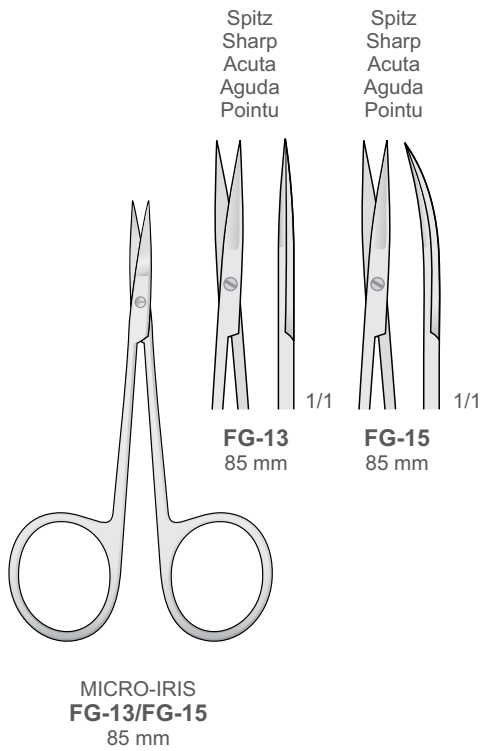

Scissors

Scheren
Forbici
Tijeras
Ciseaux

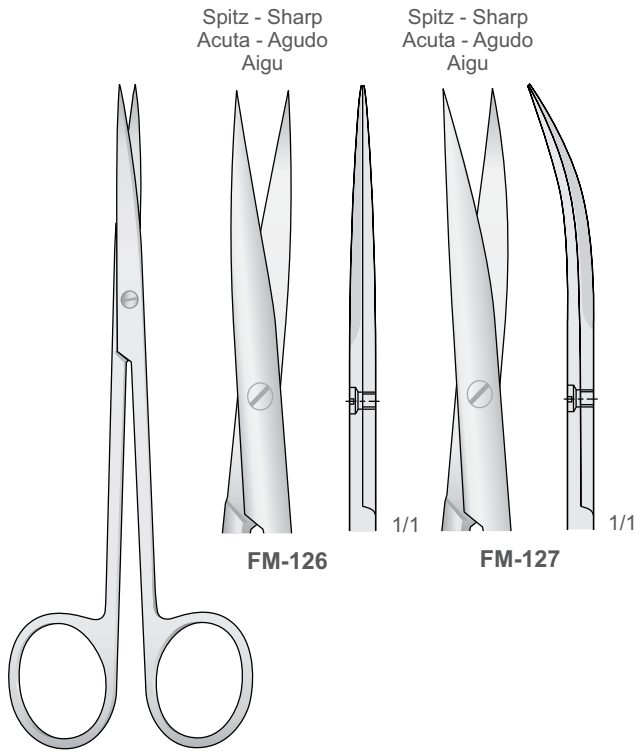

METZENBAUM
FM-126/FM-127
145 mm

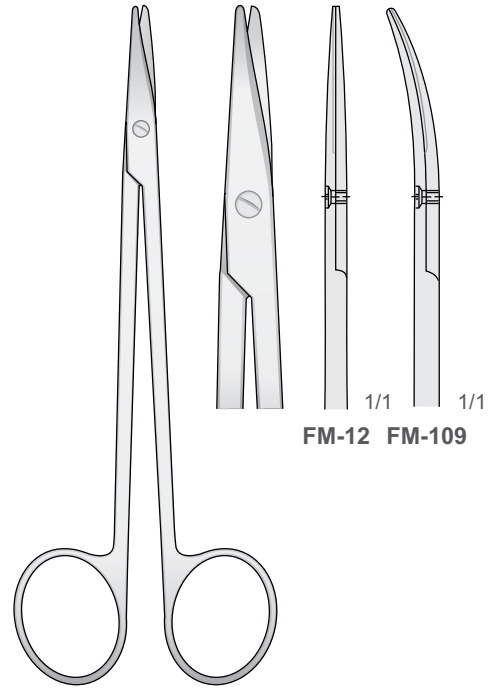

METZENBAUM
FM-12/FM-109
150 mm

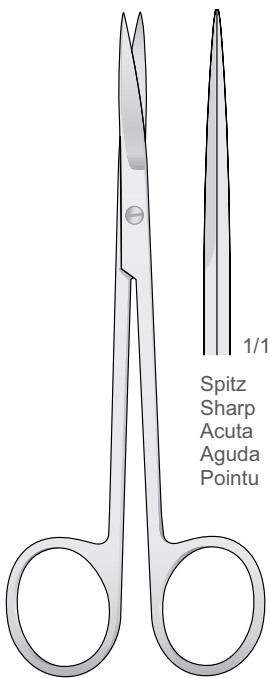

METZENBAUM
FG-28
145 mm

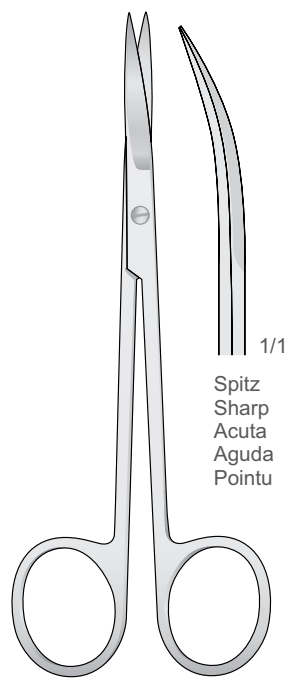

METZENBAUM
FG-14
145 mm

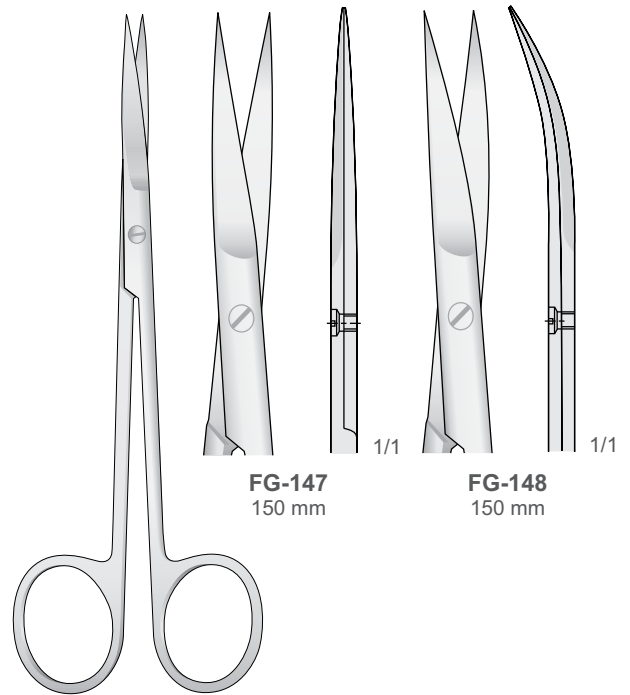

JOSEPH
FG-147/FG-148
150 mm

Scissors

Scheren
Forbici
Tijeras
Ciseaux

Scissors

Scheren
Forbici
Tijeras
Ciseaux

Stumpf
Blunt
Smussa
Romas
Mousse

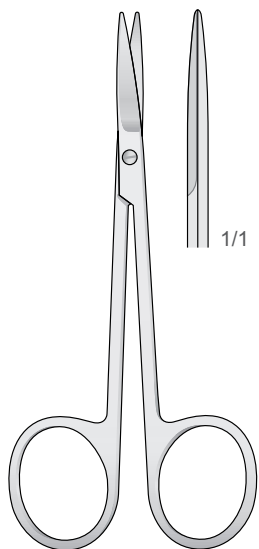

FG-101
110 mm

Stumpf
Blunt
Smussa
Romas
Mousse

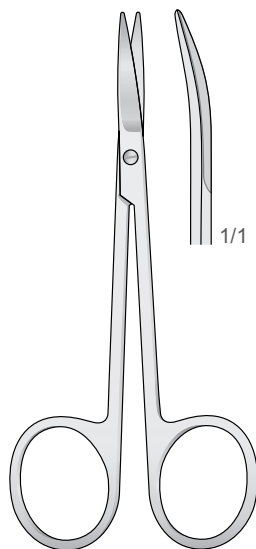

FG-102
110 mm

Stumpf
Blunt
Smussa
Romas
Mousse

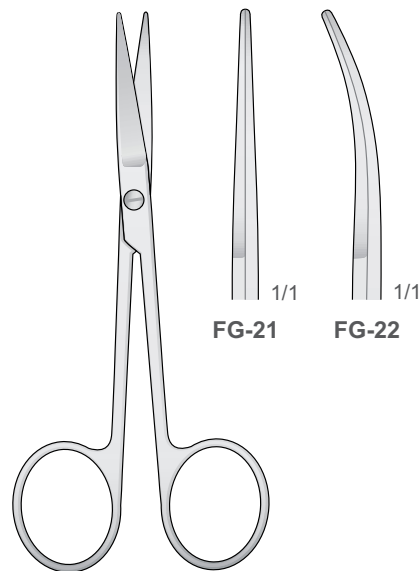

FG-21/FG-22
115 mm

Spitz
Sharp
Acute
Agudas
Pointu

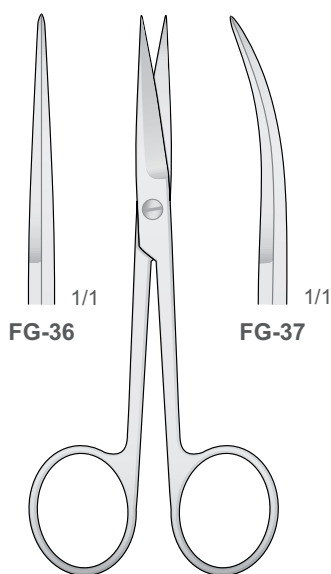

FG-36/FG-37
115 mm

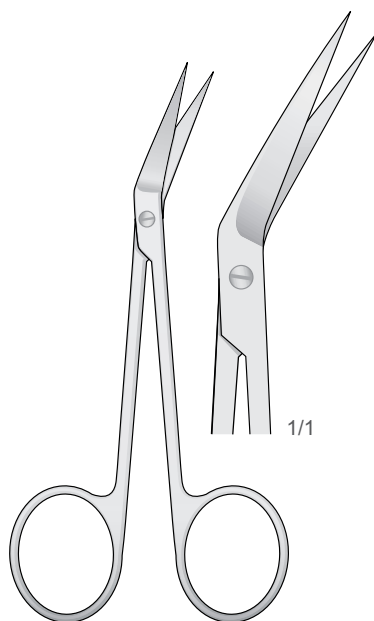

LOCKLIN
LK-1
115 mm

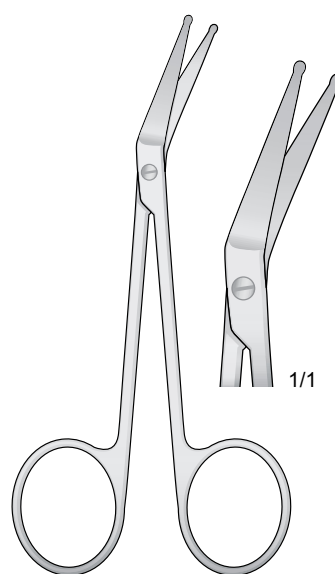

LOCKLIN MOD.
LK-3
110 mm

Scissors

Scheren
Forbici
Tijeras
Ciseaux

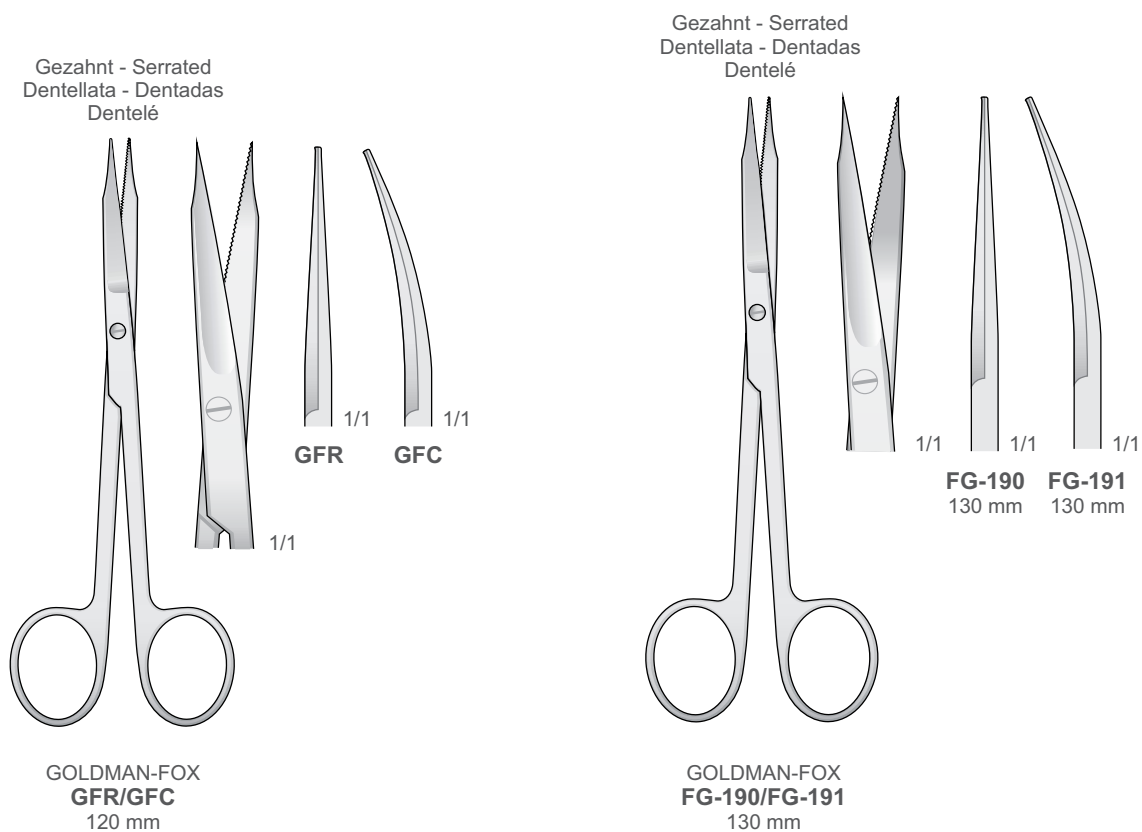
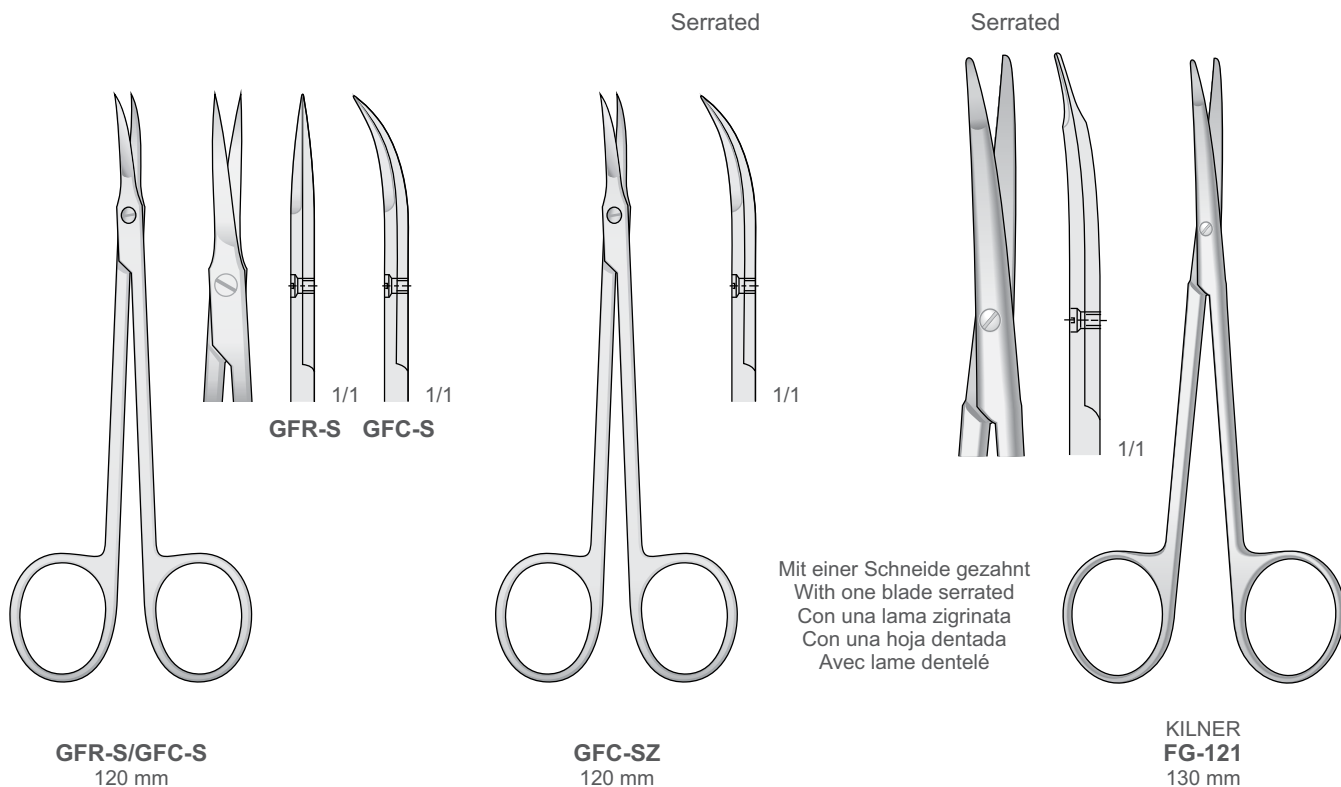

Scissors

Scheren
Forbici
Tijeras
Ciseaux

Scissors

Scheren
Forbici
Tijeras
Ciseaux

Gezahnt - Serrated
Dentellata - Dentadas
Dentelé

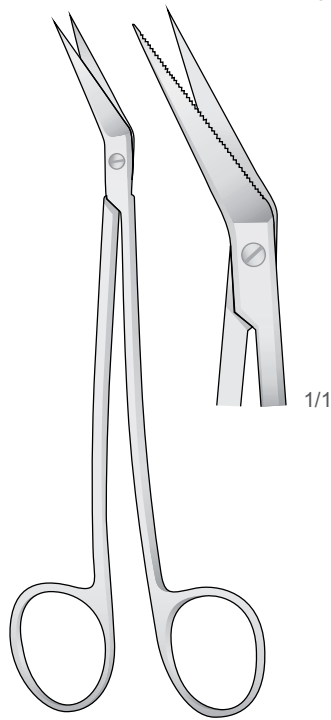

LOCKLIN
LK-2
160 mm

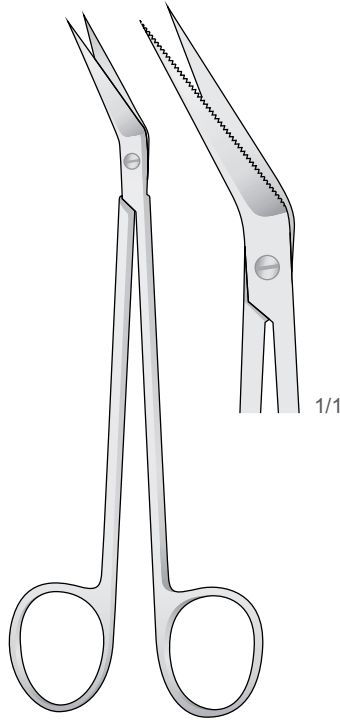

LOCKLIN
LK-4
160 mm

Gezahnt - Serrated
Dentellata - Dentadas
Dentelé

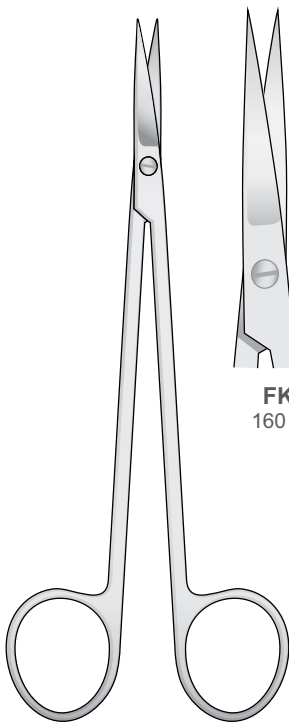

KELLY
FK-1/FK-2
160 mm

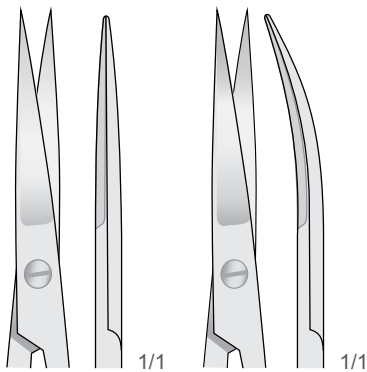

FK-1
160 mm

FK-2
160 mm

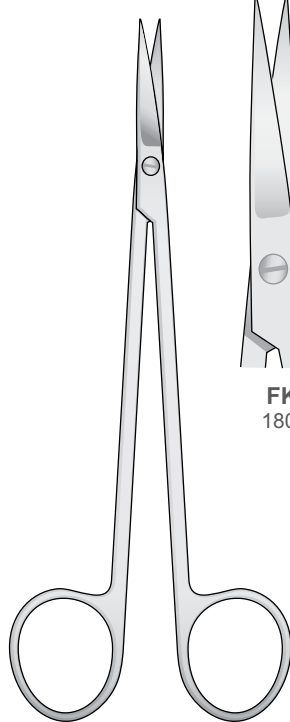

KELLY
FK-87/FK-88
180 mm

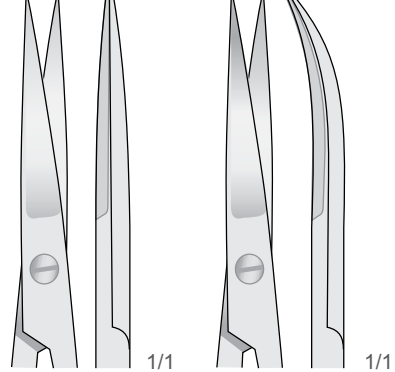

FK-87
180 mm

FK-88
180 mm

Scissors

Scheren
Forbici
Tijeras
Ciseaux

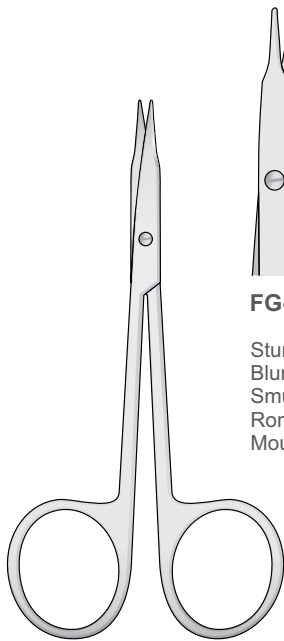

STEVENS
FG-50/FG-53
110 mm

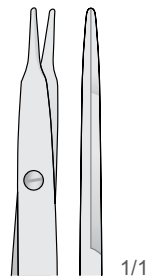

FG-50

Stumpf Gerade
Blunt Straight
Smussa Diritta
Romas Rectas
Mousse Droites

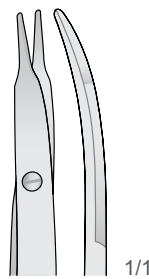

FG-51

Stumpf Gebogen
Blunt Curved
Smussa Curva
Romas Curvas
Mousse Courbes

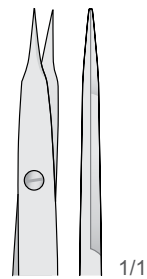

FG-52

Spitz Gerade
Sharp Straight
Acuta Diritta
Agudas Rectas
Pointu Droites

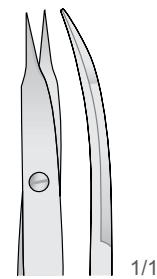

FG-53

Spitz Gebogen
Sharp Curved
Acuta Curva
Agudas Curvas
Pointu Courbes

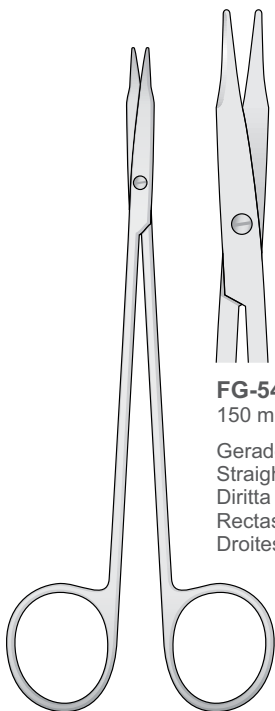

REYNOLDS
FG-54/FG-55

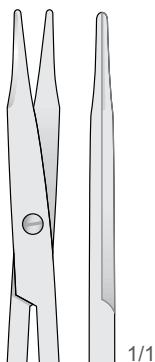

FG-54
150 mm

Gerade
Straight
Diritta
Rectas
Droites

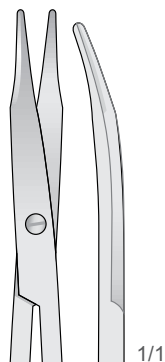

FG-55
150 mm

Gebogen
Curved
Curva
Curvas
Courbes

Stumpf
Blunt
Smussa
Romas
Mousse

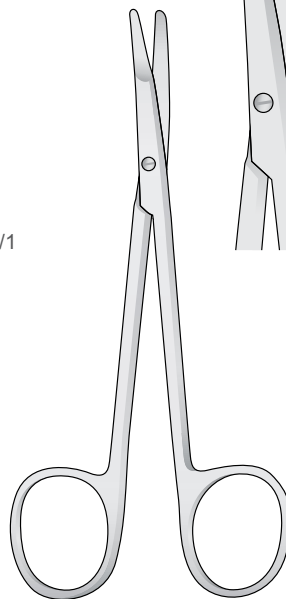

KILNER
FG-19C/FG-67

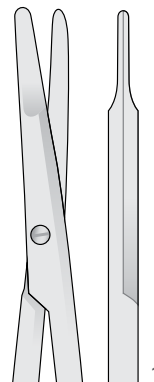

FG-66
120 mm

Gerade
Straight
Diritta
Rectas
Droites

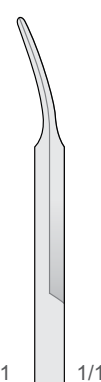

FG-67
120 mm

Gebogen
Curved
Curva
Curvas
Courbes

Stumpf
Blunt
Smussa
Romas
Mousse

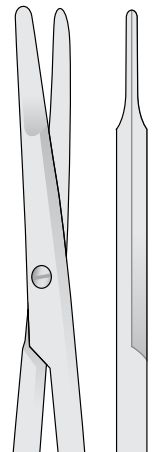

FG-19R
135 mm

Gerade
Straight
Diritta
Rectas
Droites

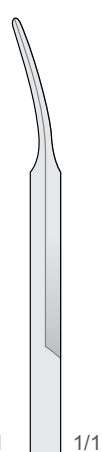

FG-19C
135 mm

Gebogen
Curved
Curva
Curvas
Courbes

Scissors

Scheren
Forbici
Tijeras
Ciseaux

Scissors

Scheren
Forbici
Tijeras
Ciseaux

Gezahnt - Serrated
Dentellata - Dentadas
Dentelé

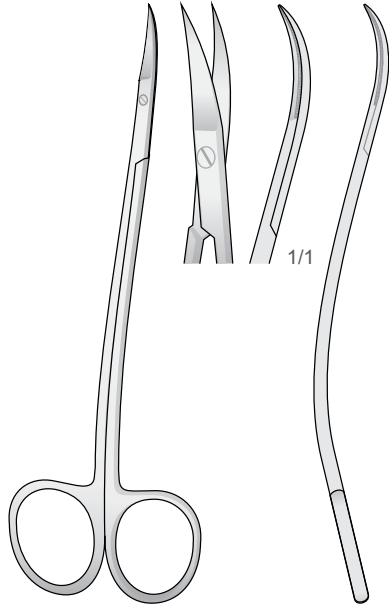

LA GRANGE
LG-1
115 mm

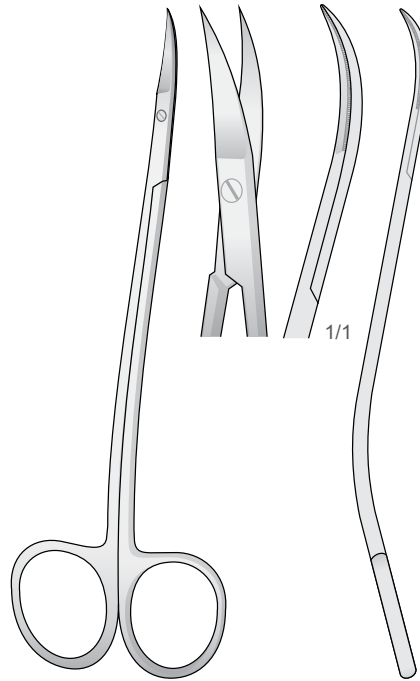

LA GRANGE
LG-6
155 mm

Gezahnt - Serrated
Dentellata - Dentada
Dentée

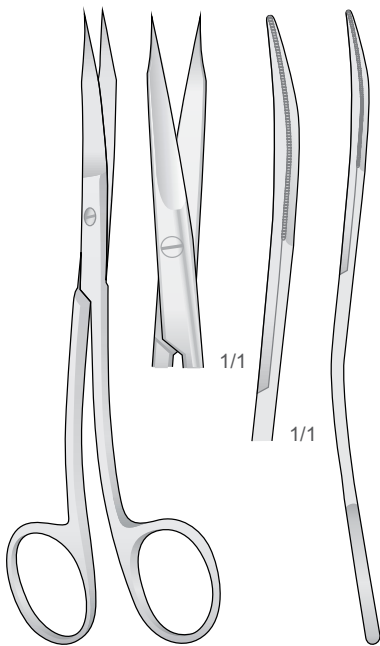

GOLDMAN-FOX S FORM
GFS
130 mm

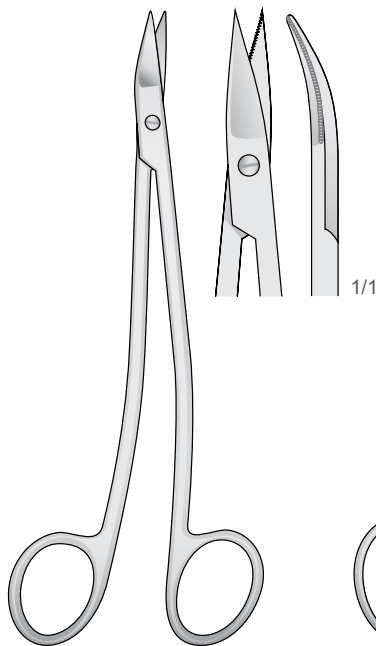

NEUMANN
FG-20
130 mm

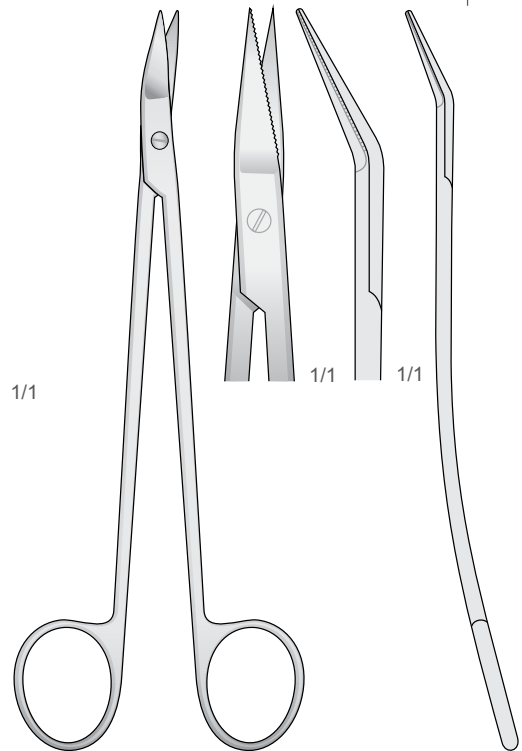

DEAN
DEAN
180 mm

Scissors

Scheren
Forbici
Tijeras
Ciseaux

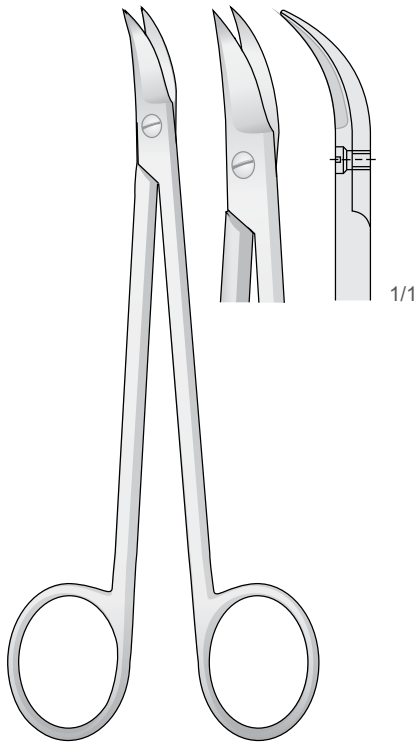

QUINBY
FG-38
130 mm

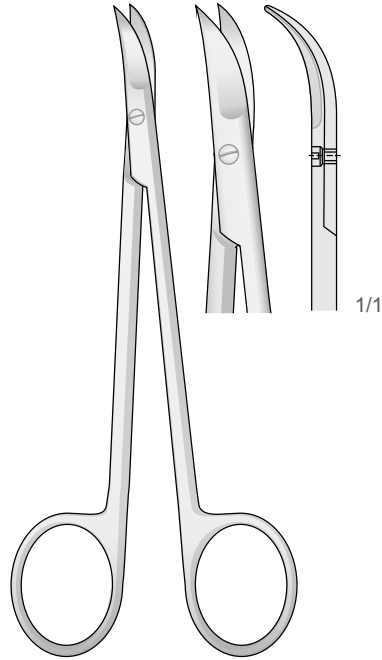

CHADWICK
FG-39
115 mm

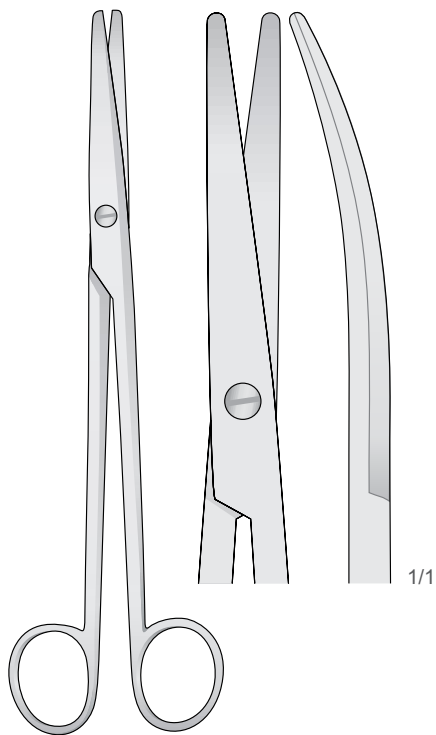

MAYO-LEXER
FM-79
165 mm

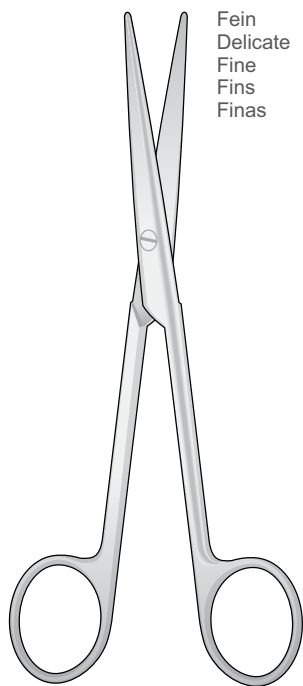

LEXER
FM-180/FM-181
165 mm

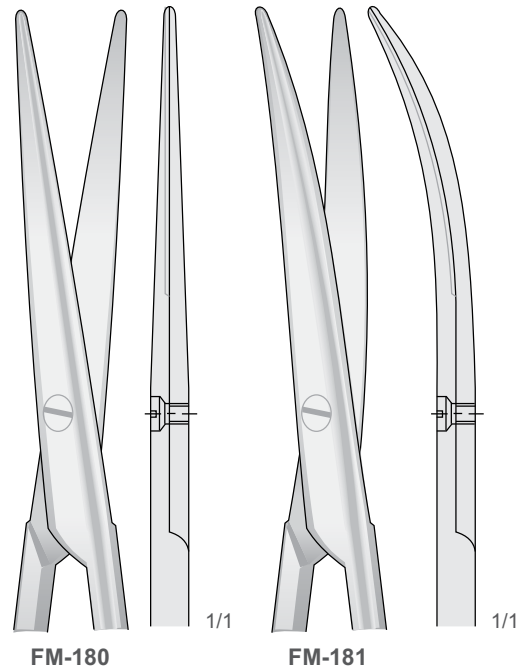

Fein
Delicate
Fine
Fins
Finas

FM-180

FM-181

Scissors

Scheren
Forbici
Tijeras
Ciseaux

Scissors

Scheren
Forbici
Tijeras
Ciseaux

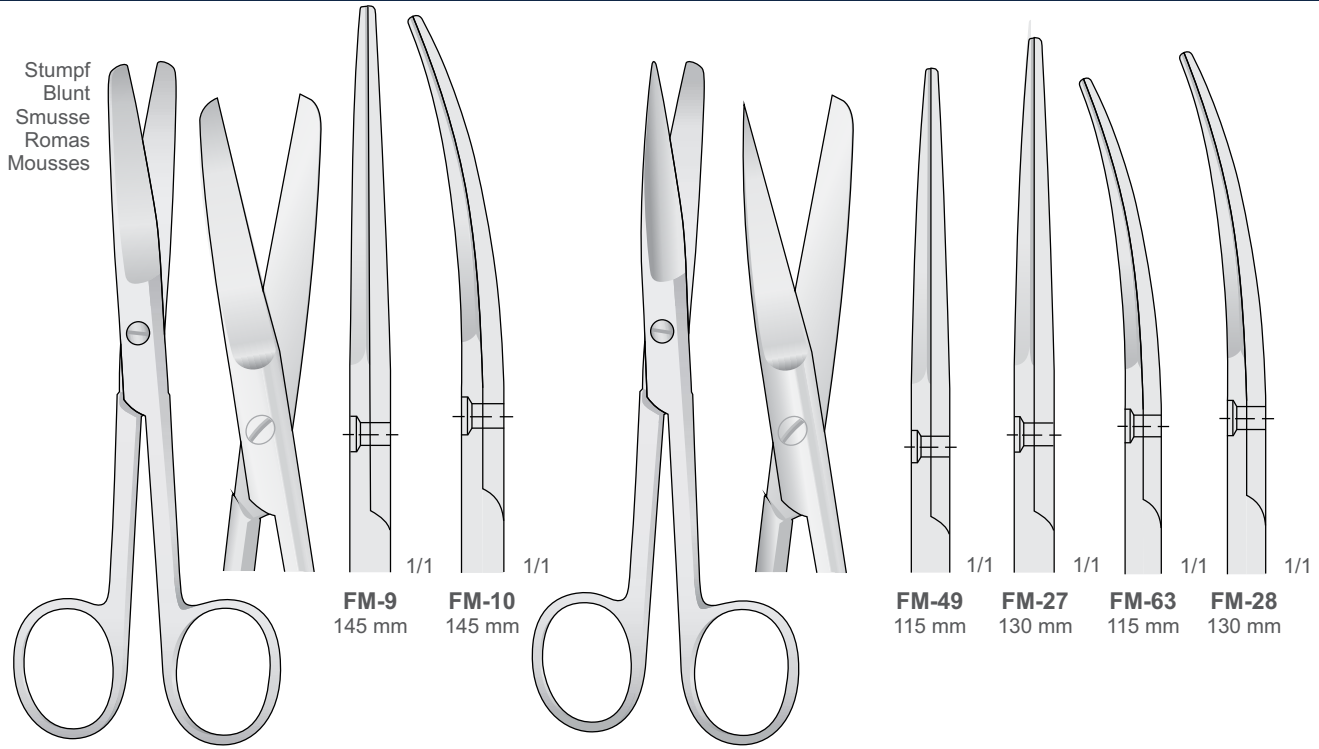

Stumpf
Blunt
Smusse
Romas
Mousses

FM-9
145 mm

FM-10
145 mm

FM-49
115 mm

FM-27
130 mm

FM-63
115 mm

FM-28
130 mm

FM-9/FM-10
145 mm

FM-27/FM-63

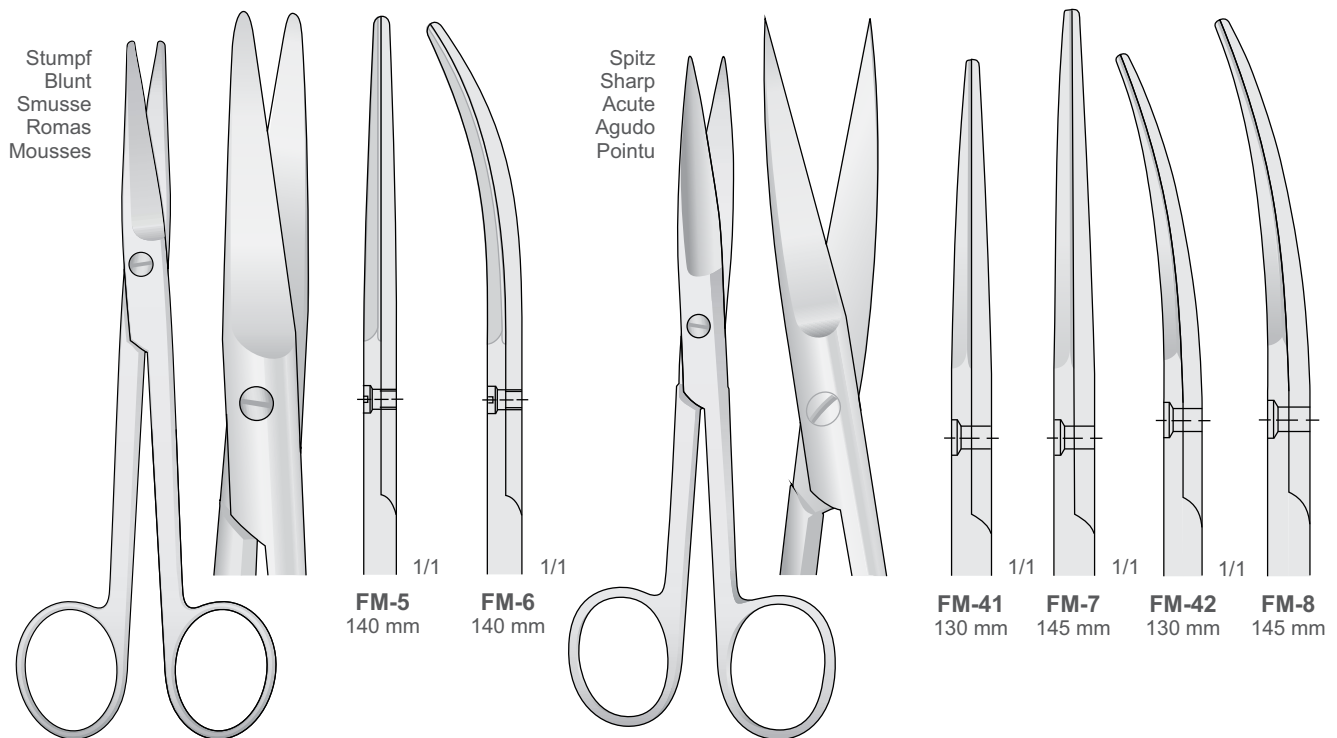

Stumpf
Blunt
Smusse
Romas
Mousses

Spitz
Sharp
Acute
Agudo
Pointu

FM-5
140 mm

FM-6
140 mm

FM-41
130 mm

FM-7
145 mm

FM-42
130 mm

FM-8
145 mm

MAYO
FM-5/FM-6
140 mm

FM-7/FM-42

Scissors

Scheren
Forbici
Tijeras
Ciseaux

SUPER CUT

Regular Edge **SUPER CUT Edge**

Super Cut Scissors have specially designed cutting edges. One regular edge and **one sharp-knife edge.**

Extremely Sharp Razor Edge / Atraumatic
Extrem Scharfe Spitzer Beck / Atraumatische
Tranchant extrêmement aiguisée / Atraumatique
Borde extremadamente afilado / Atraumática
Taglio estremamente affilato / Atraumatica

One side serrated
Eine seite gezahnt
Un côté dentelé
Un lado dentado
Un lato dentellato

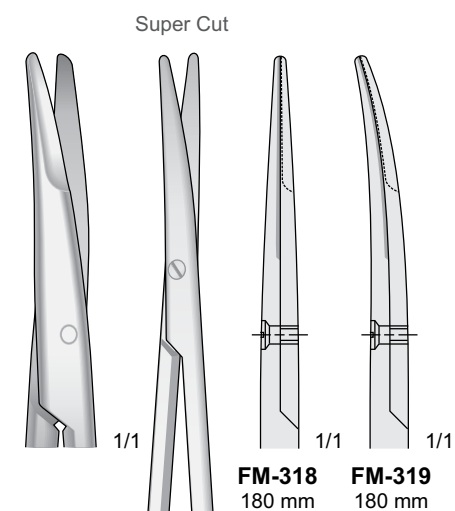

METZENBAUM
FM-318/FM-319
180 mm

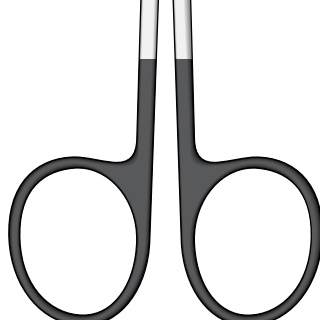
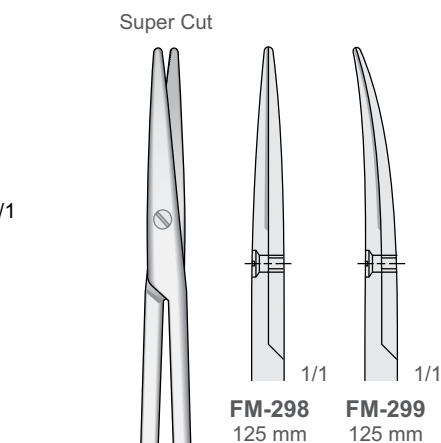

METZENBAUM
FM-298/FM-299
125 mm

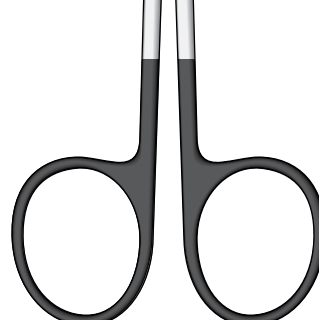
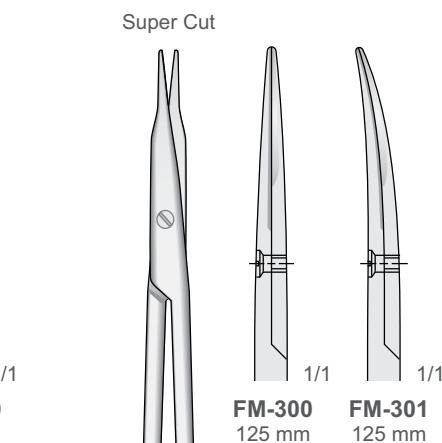

STEVENS
FM-300/FM-301
125 mm

Scissors

Scheren
Forbici
Tijeras
Ciseaux

Scissors

Scheren
Forbici
Tijeras
Ciseaux

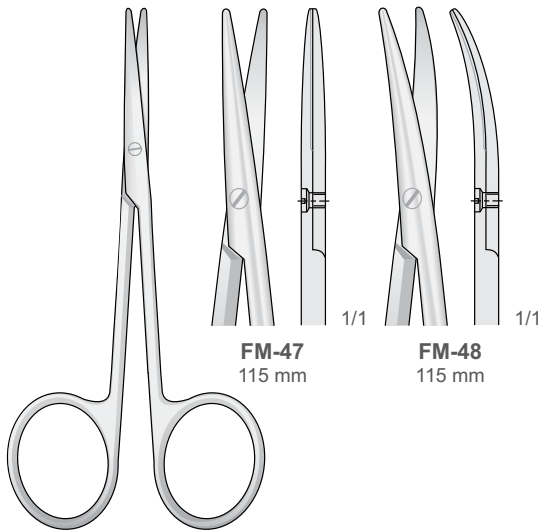

FM-47
115 mm

FM-48
115 mm

BABY - METZENBAUM
FM-47/FM-48
115 mm

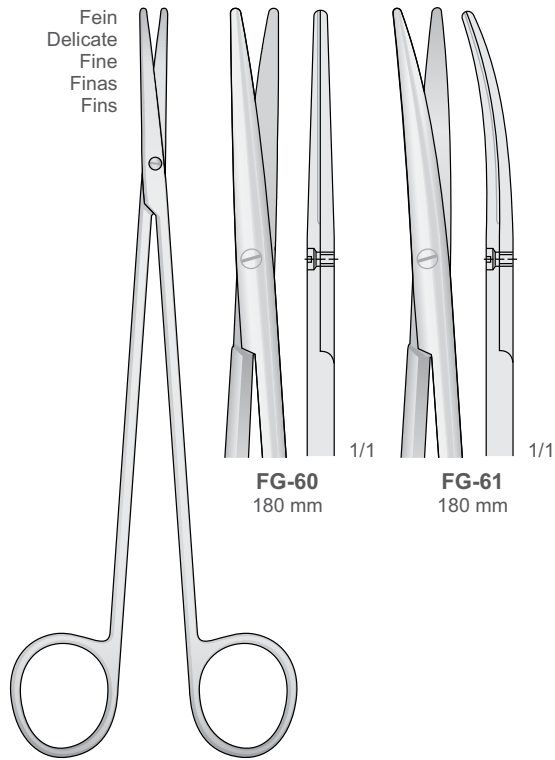

Fein
Delicate
Fine
Finas
Fins

FG-60
180 mm

FG-61
180 mm

TOENNIS-ADSON
FG-60/FG-61
180 mm

Präparierscheren - Dissecting Scissors
Forbici per dissezione - Tijeras de dissección - Ciseaux à dissection

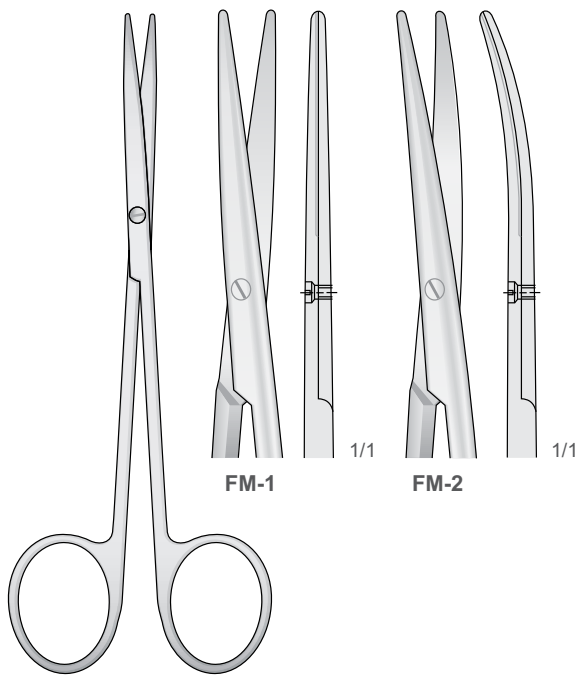

FM-1

FM-2

METZENBAUM
FM-1/FM-2
145 mm

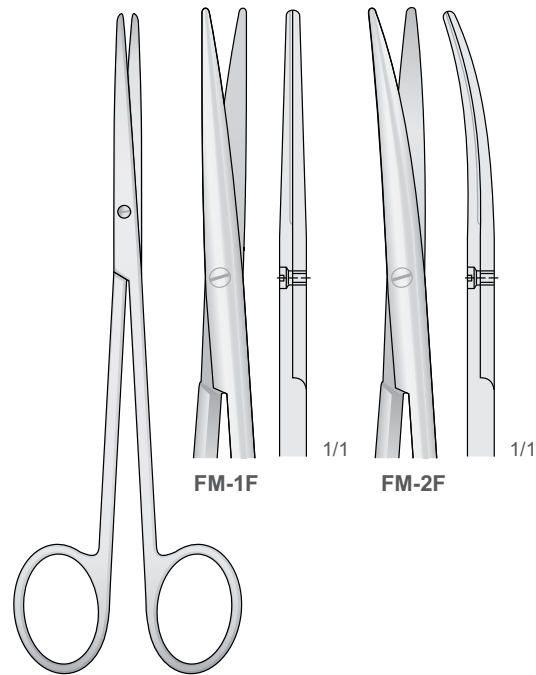

FM-1F

FM-2F

METZENBAUM-FINO
FM-1F/FM-2F
145 mm

Scissors

Scheren
Forbici
Tijeras
Ciseaux

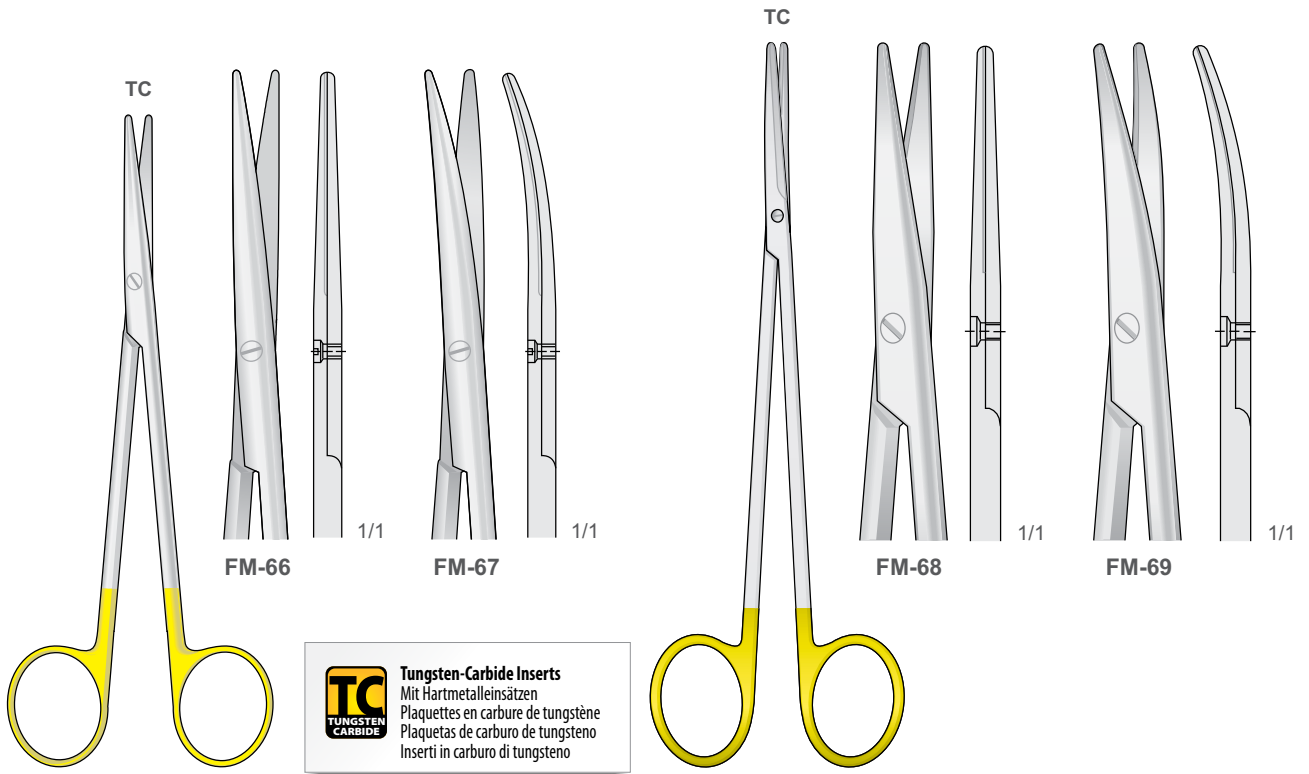

METZENBAUM
FM-66/FM-67
145 mm

METZENBAUM
FM-68/FM-69
185 mm

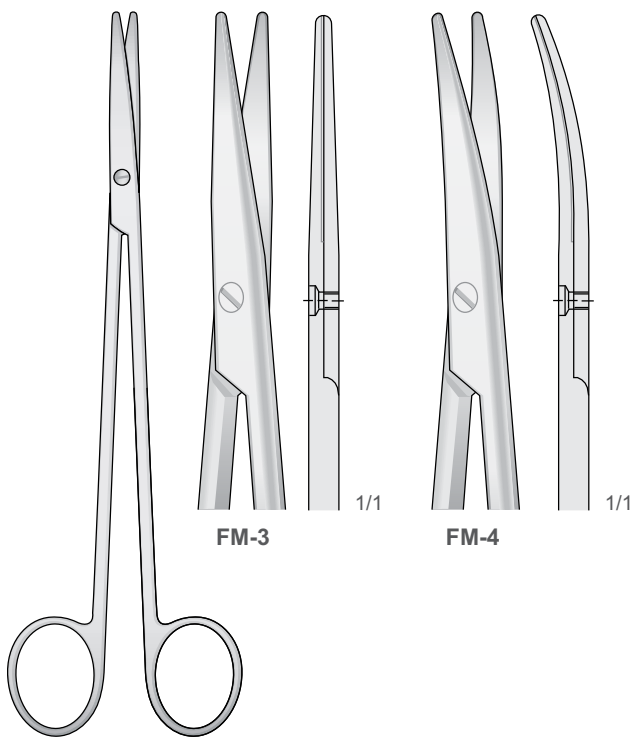

METZENBAUM
FM-3/FM-4
185 mm

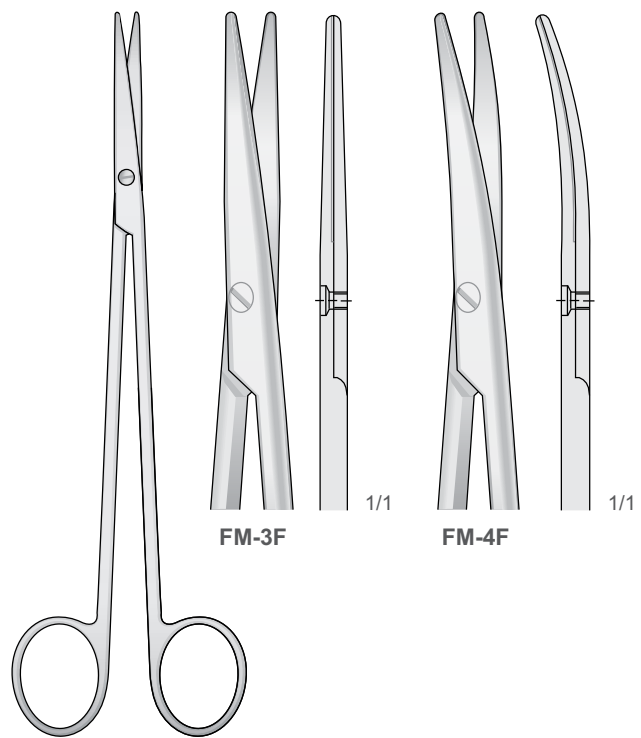

METZENBAUM-FINO
FM-3F/FM-4F
185 mm

Scissors

Scheren
Forbici
Tijeras
Ciseaux

Scissors

Scheren
Forbici
Tijeras
Ciseaux

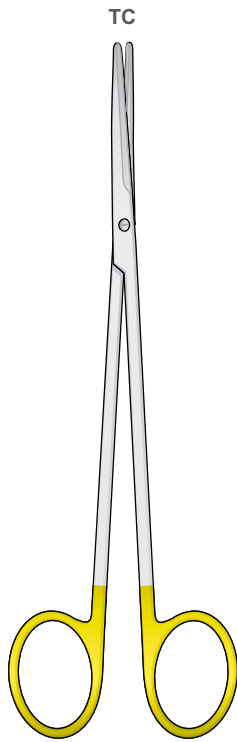

METZENBAUM-FINO
FM-201/FM-204

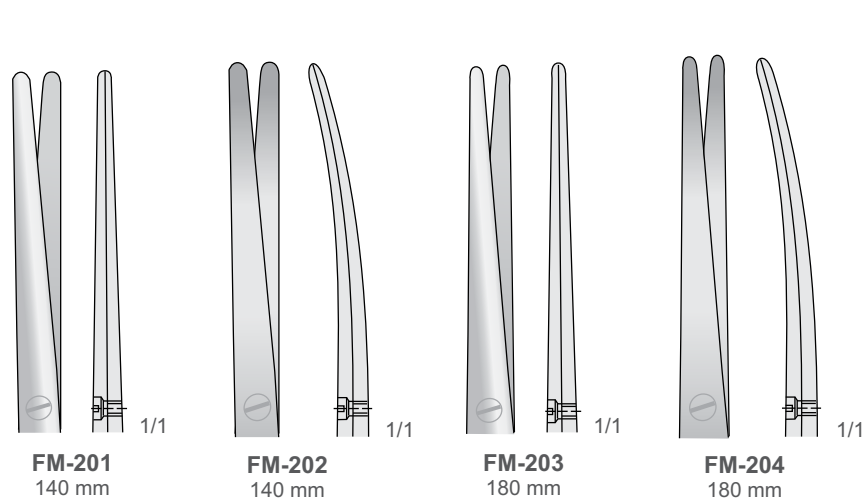

TC
TUNGSTEN
CARBIDE

Tungsten-Carbide Inserts
Mit Hartmetalleinsätzen
Plaquettes en carbure de tungstène
Plaquetas de carburo de tungsteno
Inserti in carburo di tungsteno

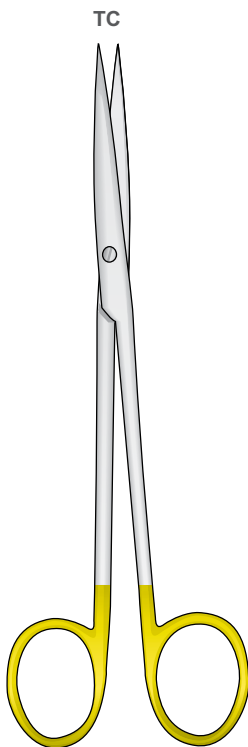

METZENBAUM-FINO
FM-96/FM-99

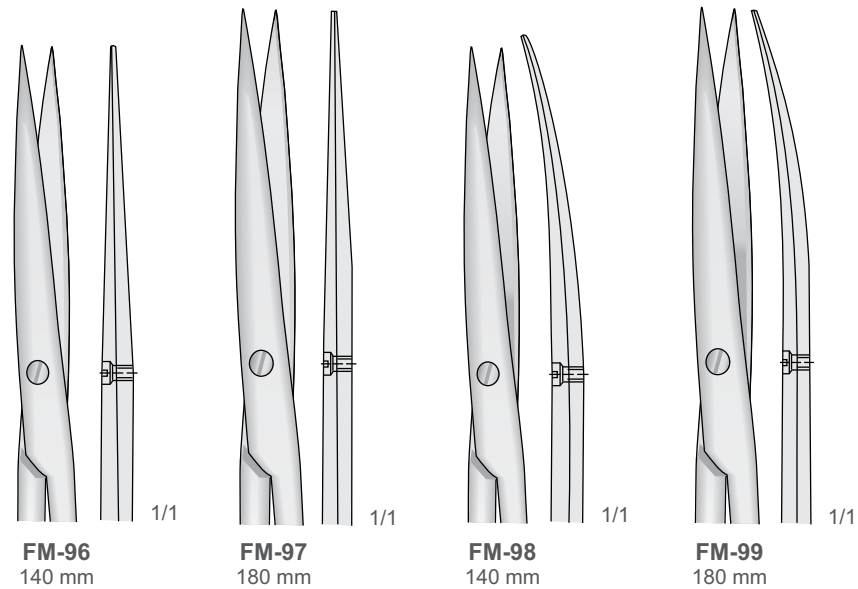

Scissors

Scheren
Forbici
Tijeras
Ciseaux

Scheren
Scissors
Forbici
Tijeras
Ciseaux



Tungsten-Carbide Inserts
Mit Hartmetalleinsätzen
Plaquettes en carbure de tungstène
Plaquetas de carburo de tungsteno
Inserti in carburo di tungsteno

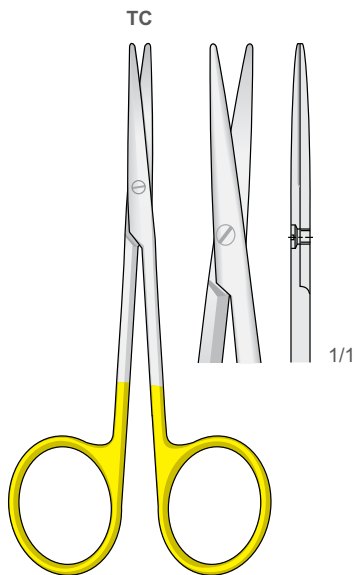

BABY-METZENBAUM
FM-118
115 mm

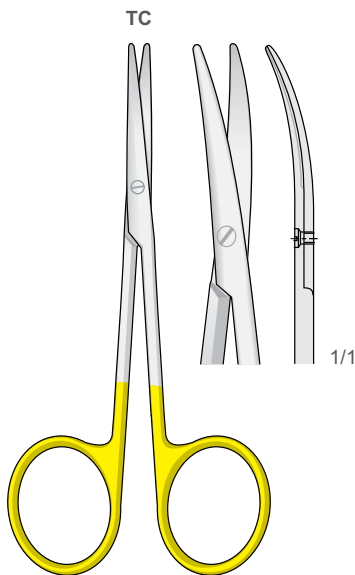

BABY-METZENBAUM
FM-119
115 mm

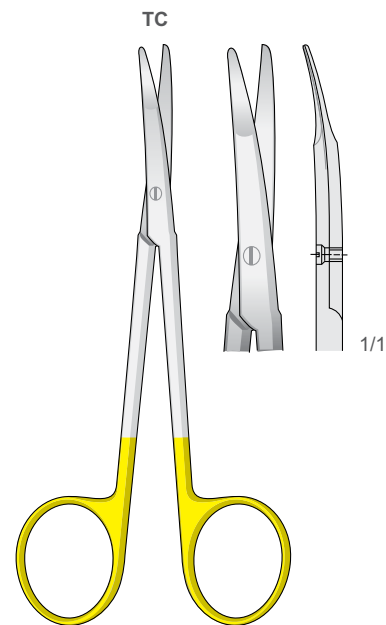

KILNER
FM-350
125 mm

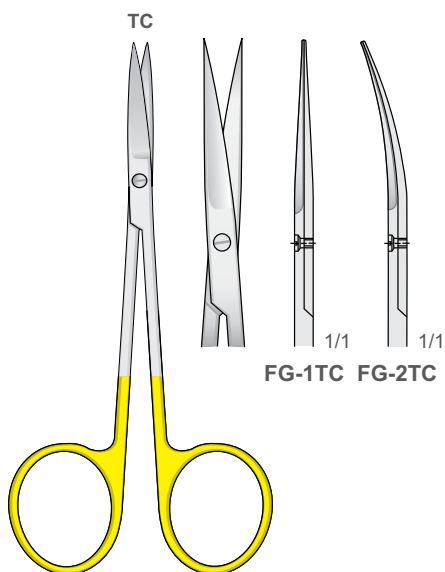

IRIS
FG-1TC/FG-2TC
115 mm

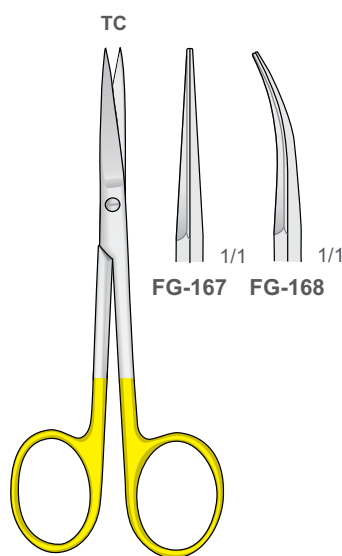

FG-167/FG-168
110 mm

Gebogen - Curved
Curva - Curvas
Courbes

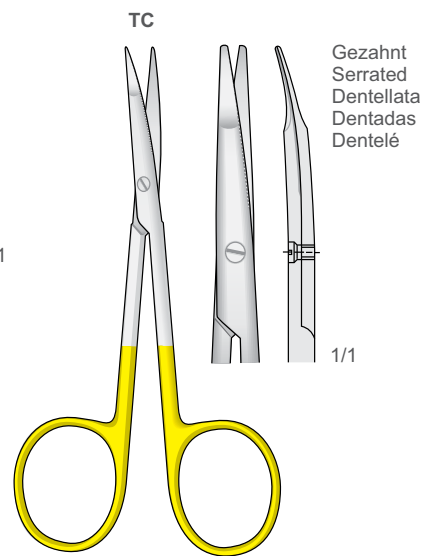

GREENBERG-PAR
FM-317
115 mm

Gezahnt
Serrated
Dentellata
Dentadas
Dentelé

Scissors

Scheren
Forbici
Tijeras
Ciseaux

Scissors

Scheren
Forbici
Tijeras
Ciseaux

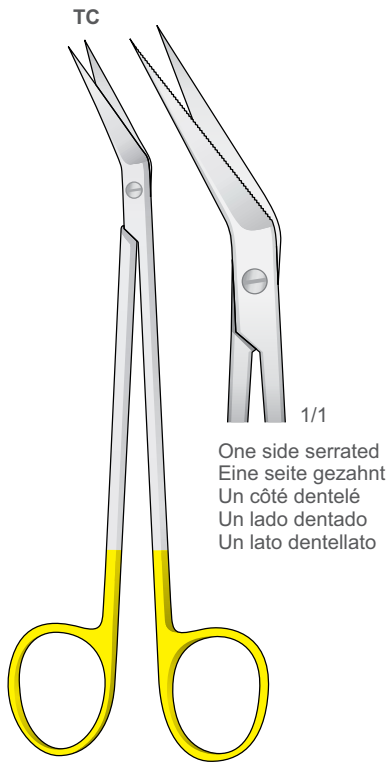

One side serrated
Eine seite gezahnt
Un côté dentelé
Un lado dentado
Un lato dentellato

LK-10
160 mm

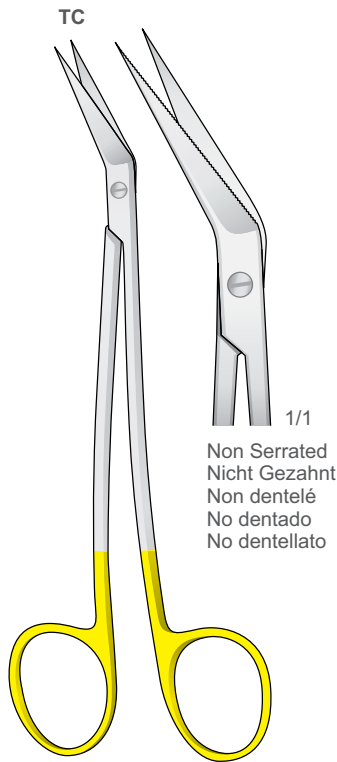

Non Serrated
Nicht Gezahnt
Non dentelé
No dentado
No dentellato

LK-12
160 mm



Tungsten-Carbide Inserts
Mit Hartmetalleinsätzen
Plaquettes en carbure de tungstène
Plaquetas de carburo de tungsteno
Inserti in carburo di tungsteno

Eine Schneide gezahnt S-förmig gebogen
One toothed cutting edge S-shaped
Una lama dentata curva a forma S
Una hoja dentada forma S
Une lame dentelée courbés en S

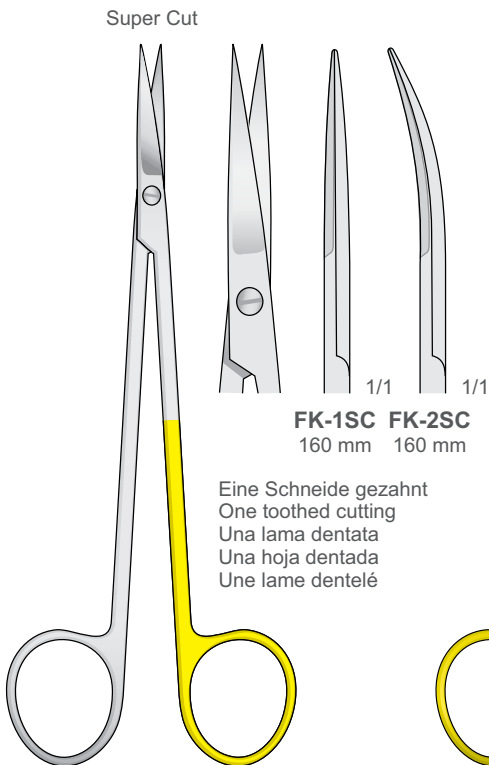

Eine Schneide gezahnt
One toothed cutting
Una lama dentata
Una hoja dentada
Une lame dentelé

KELLY
FK-1SC/FK-2SC
160 mm

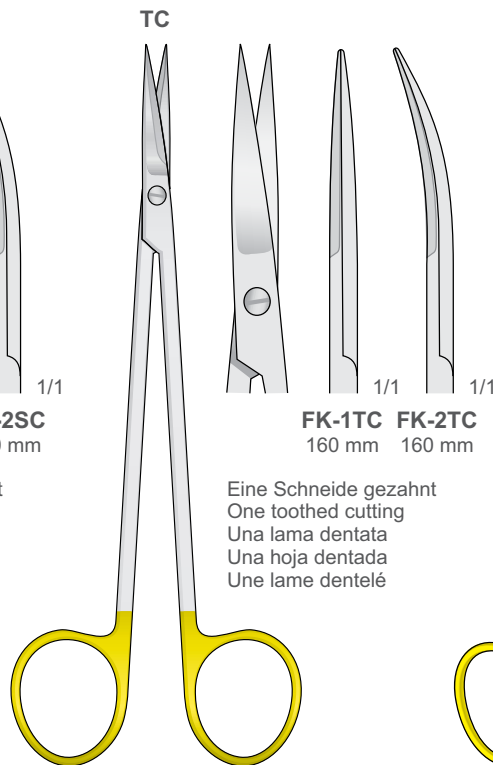

Eine Schneide gezahnt
One toothed cutting
Una lama dentata
Una hoja dentada
Une lame dentelé

KELLY
FK-1TC/FK-2TC
160 mm

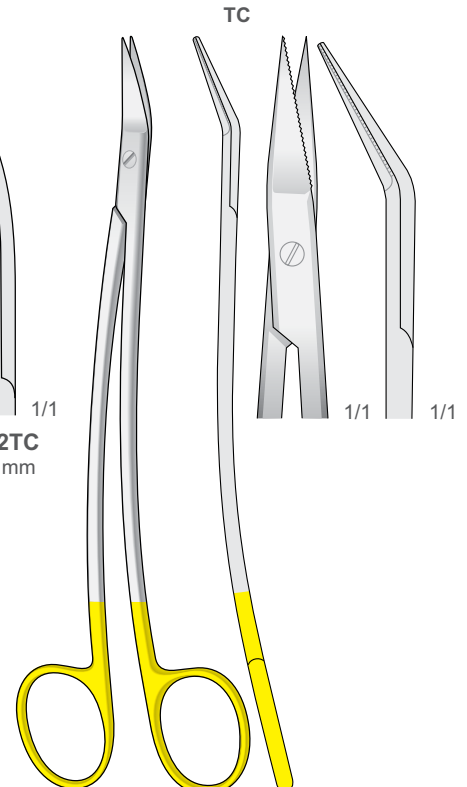

DEAN-TC
175 mm

Scissors

Scheren
Forbici
Tijeras
Ciseaux

Wellenschliff
TC

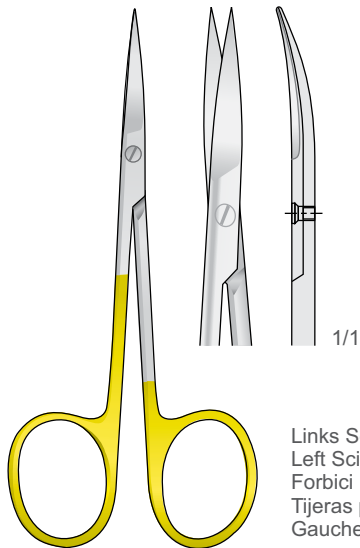

IRIS
FM-100L
110 mm

Links Scheren
Left Scissors
Forbici per mancini
Tijeras para zurdos
Gauche Ciseaux

TC
TUNGSTEN
CARBIDE

Tungsten-Carbide Inserts
Mit Hartmetalleinsätzen
Plaquettes en carbure de tungstène
Plaquetas de carburo de tungsteno
Inserti in carburo di tungsteno

Wellenschliff
TC

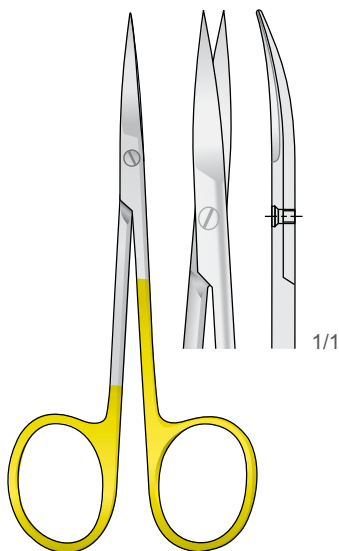

IRIS
FM-100
110 mm

Wellenschliff
TC

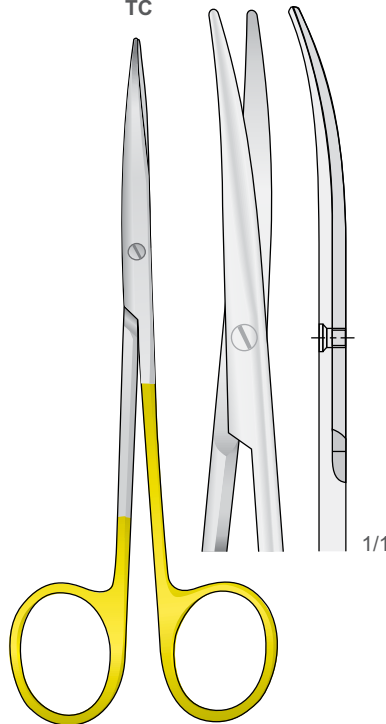

METZENBAUM
FM-102
145 mm

Wellenschliff
TC

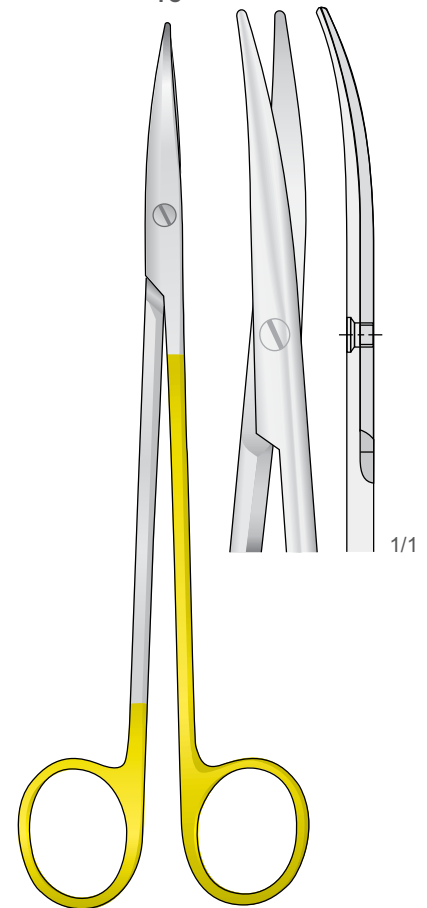

METZENBAUM
FM-104
185 mm

Scissors

Scheren
Forbici
Tijeras
Ciseaux

Scissors

Scheren
Forbici
Tijeras
Ciseaux



Extremely Sharp Razor Edge / Atraumatic
Extrem Scharfe Spitzer Beck / Atraumatische
Tranchant extrêmement aiguisée / Atraumatique
Borde extremadamente afilado / Atraumática
Taglio estremamente affilato / Atraumatica

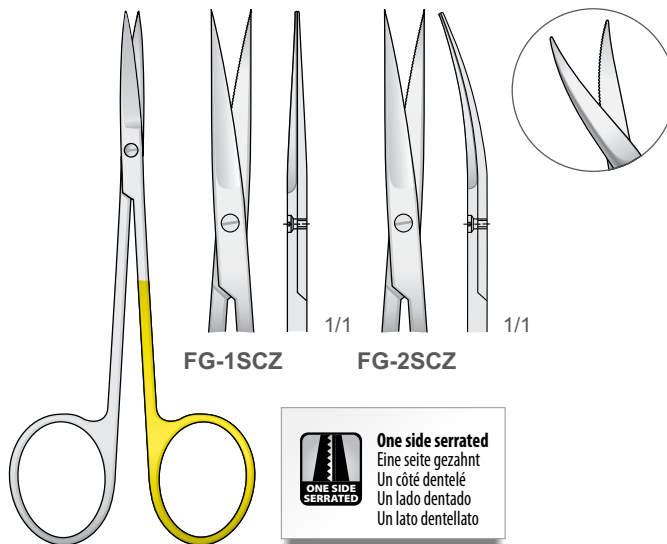

FG-1SCZ/FG-2SCZ
110 mm

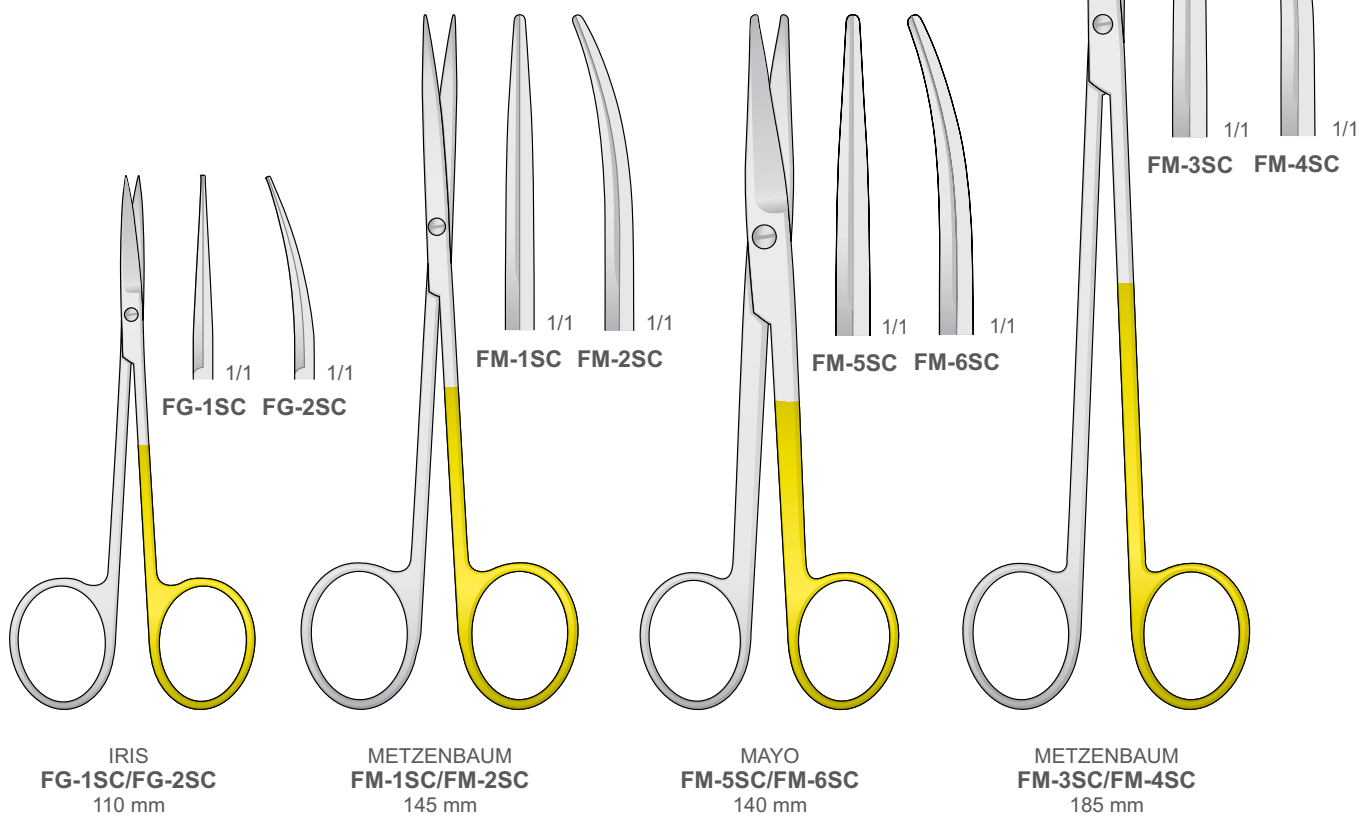

IRIS
FG-1SC/FG-2SC
110 mm

METZENBAUM
FM-1SC/FM-2SC
145 mm

MAYO
FM-5SC/FM-6SC
140 mm

METZENBAUM
FM-3SC/FM-4SC
185 mm

Scissors

Scheren
Forbici
Tijeras
Ciseaux

SUPER CUT



Super Cut Scissors have specially designed cutting edges.
One regular edge and **one sharp-knife edge.**



Extremely Sharp Razor Edge / Atraumatic
Extrem Scharfe Spitzer Beck / Atraumatische
Tranchant extrêmement aiguisée / Atraumatique
Borde extremadamente afilado / Atraumática
Taglio estremamente affilato / Atraumatica



One side serrated
Eine seite gezahnt
Un côté dentelé
Un lado dentado
Un lato dentellato

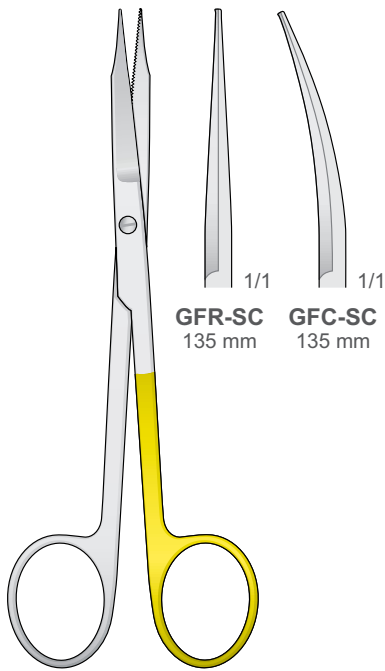

**GOLDMAN-FOX
GFR-SC/GFC-SC**
135 mm

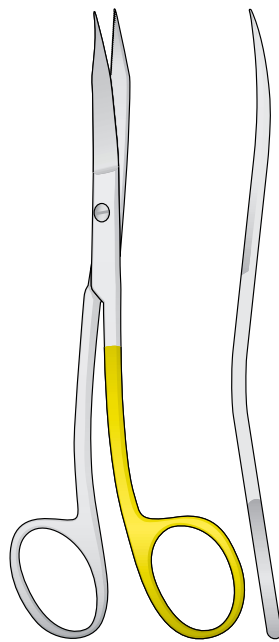

**GOLDMAN-FOX S FORM
GFS-SC**
130 mm

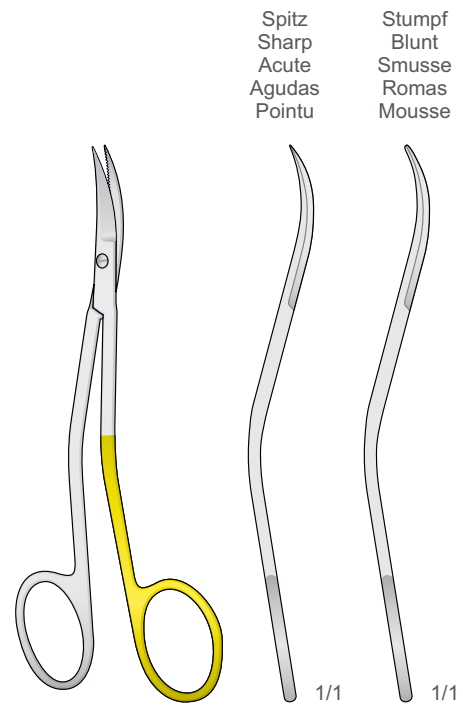

**LA GRANGE
LG-1SC/LG-2SC**
115 mm

**LA GRANGE
LA GRANGE
LG-1SC
LA GRANGE
LG-2SC**

Spitz
Sharp
Acute
Agudas
Pointu

Stumpf
Blunt
Smusse
Romas
Mousse

Scissors

Scheren
Forbici
Tijeras
Ciseaux

Scissors

Scheren
Forbici
Tijeras
Ciseaux

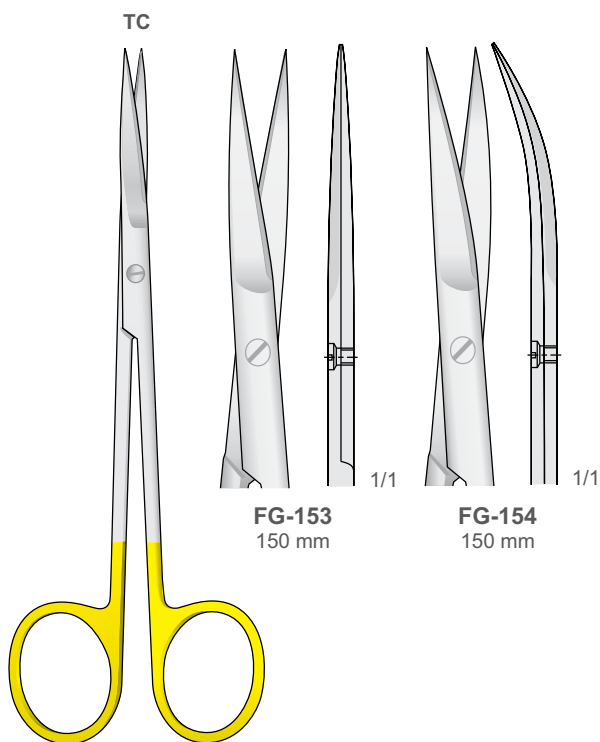

JOSEPH
FG-153/FG-154
150 mm

TC
TUNGSTEN
CARBIDE

Tungsten-Carbide Inserts
Mit Hartmetalleinsätzen
Plaquettes en carbure de tungstène
Plaquetas de carburo de tungsteno
Inserti in carburo di tungsteno

**ONE SIDE
SERRATED**

One side serrated
Eine seite gezahnt
Un côté dentelé
Un lado dentado
Un lato dentellato

**ONE SIDE
SERRATED**

One side serrated
Eine seite gezahnt
Un côté dentelé
Un lado dentado
Un lato dentellato

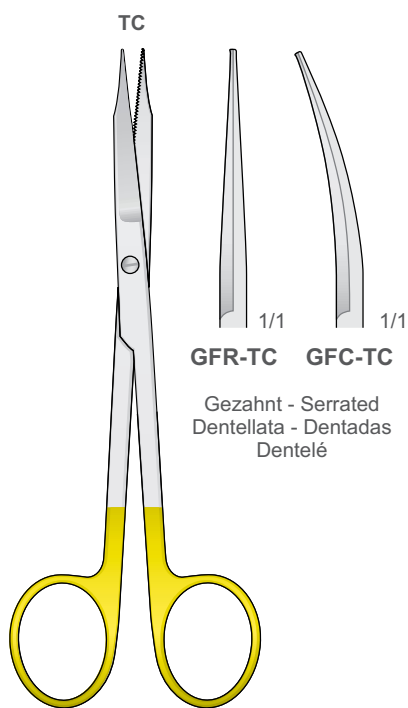

GOLDMAN-FOX
GFC-TC/GFR-TC
135 mm

GFR-TC GFC-TC
Gezahnt - Serrated
Dentellata - Dentadas
Dentelé

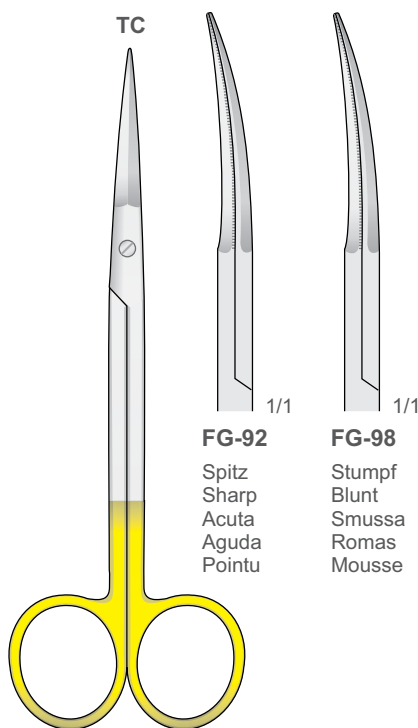

PECK-JOSEPH
FG-92/FG-98
140 mm

FG-92 FG-98
Spitz
Sharp
Acuta
Aguda
Pointu
Stumpf
Blunt
Smussa
Romass
Mousse

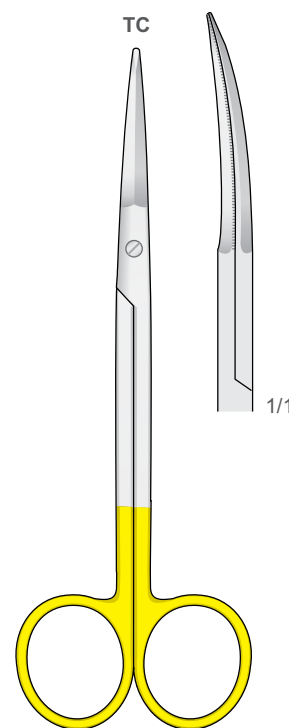

GREGORY
FM-339
140 mm

Scissors

Scheren
Forbici
Tijeras
Ciseaux

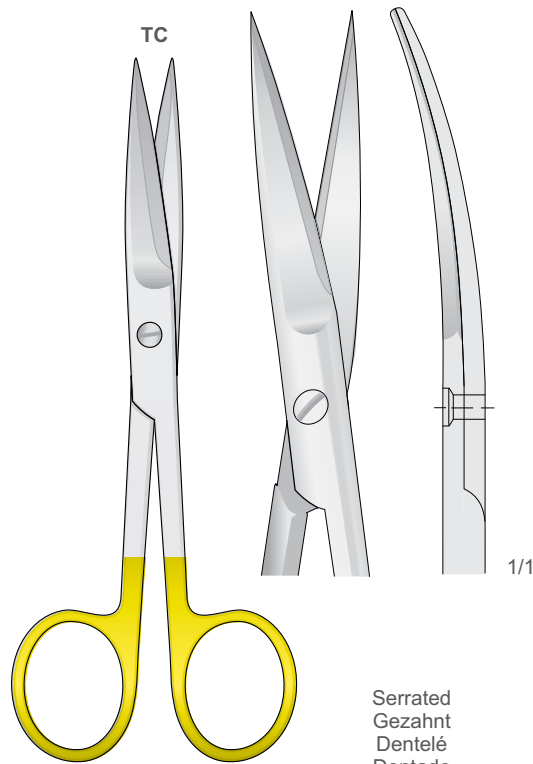

FM-146
145 mm

Serrated
Gezahnt
Dentelé
Dentado
Dentellato

Tungsten-Carbide Inserts
Mit Hartmetalleinsätzen
Plaquettes en carbure de tungstène
Plaquetas de carburo de tungsteno
Inserti in carburo di tungsteno

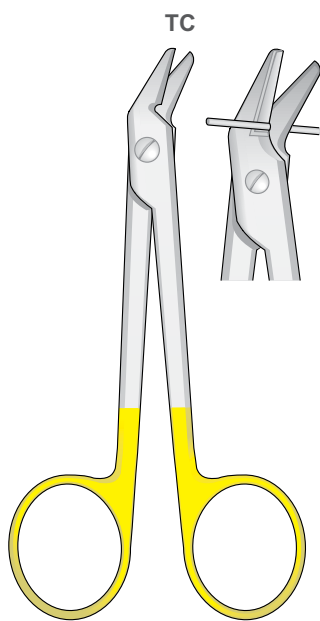

DP-120
120 mm

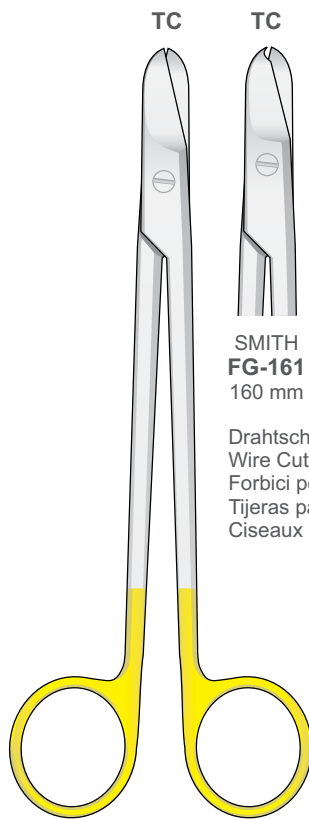

**SMITH
FG-160**
160 mm

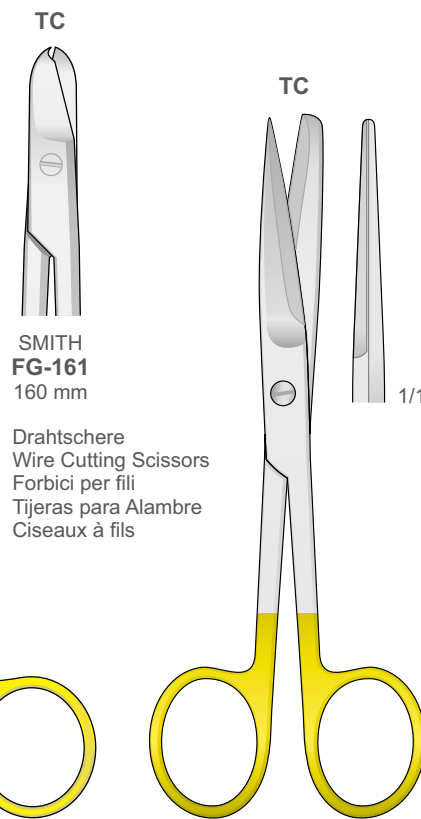

FM-51
145 mm

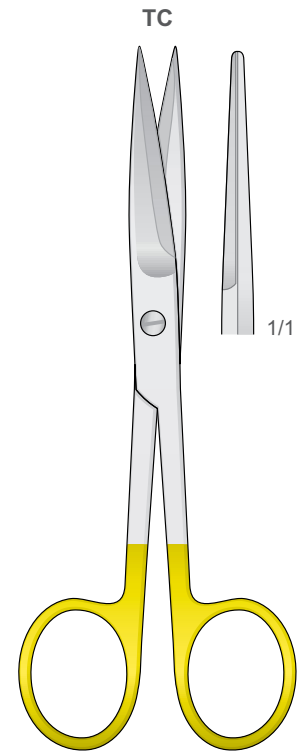

FM-59
145 mm

**SMITH
FG-161**
160 mm

Drahtschere
Wire Cutting Scissors
Forbici per fili
Tijeras para Alambre
Ciseaux à fils

Ligature Scissors

Ligatur Scheren
Forbici per legature
Tijeras para ligaduras
Ciseaux à ligatures

Scissors

Scheren
Forbici
Tijeras
Ciseaux

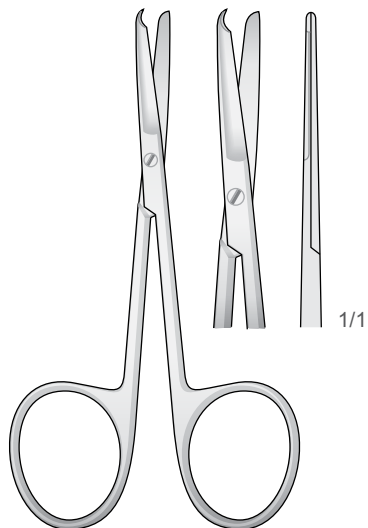

SPENCER
SC-9
90 mm

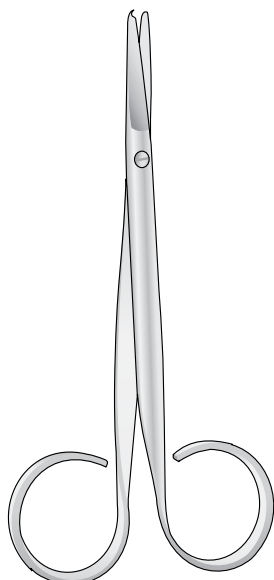

SPENCER
SC-1
110 mm

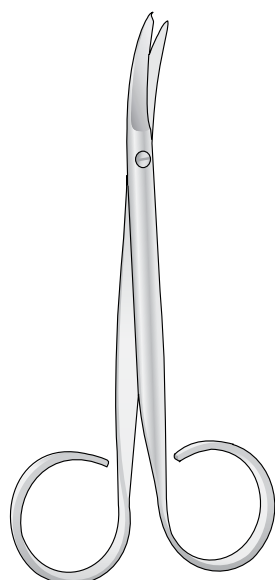

SPENCER
SC-5
110 mm

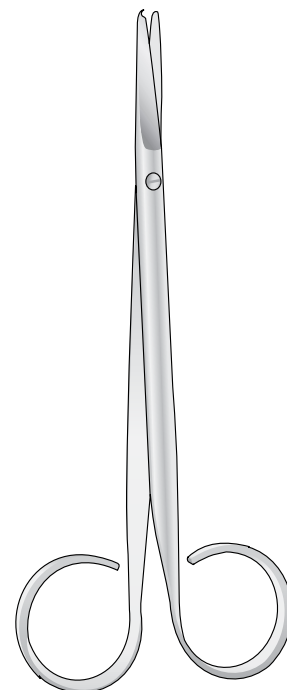

SPENCER
SC-2
145 mm

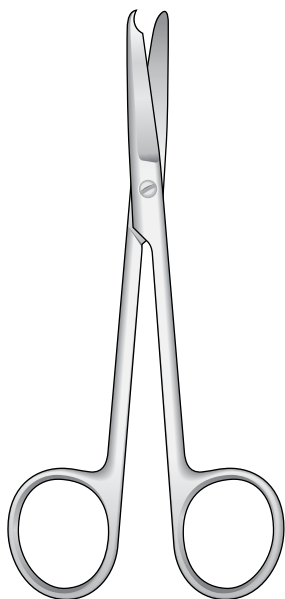

SPENCER
SC-14
120 mm

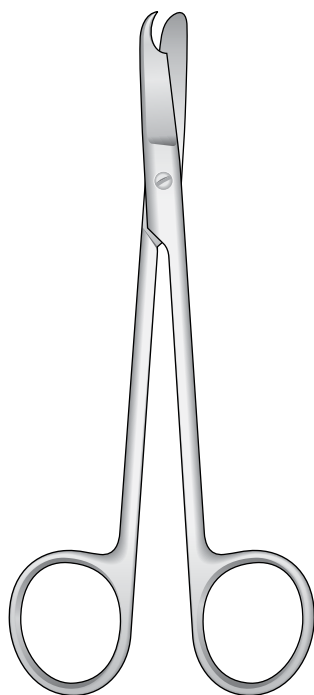

LITTAUER
SC-15
140 mm

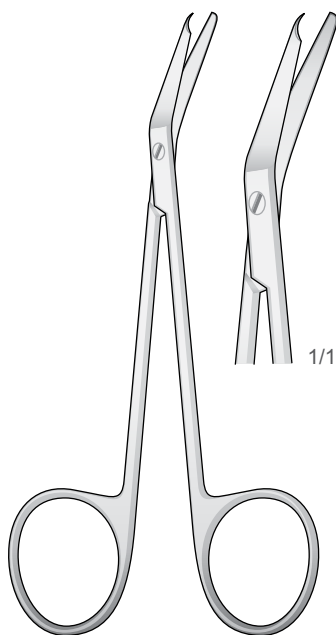

SPENCER
SC-13
130 mm

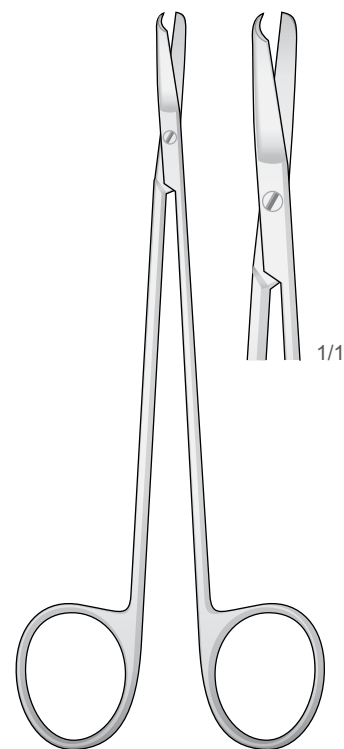

KELLY
SC-16
150 mm

Wire and plate cutting scissors

Draht und blechscheren
 Forbici per fili metallici
 Tijeras para cortar alambre
 Ciseaux coupe-fils métalliques

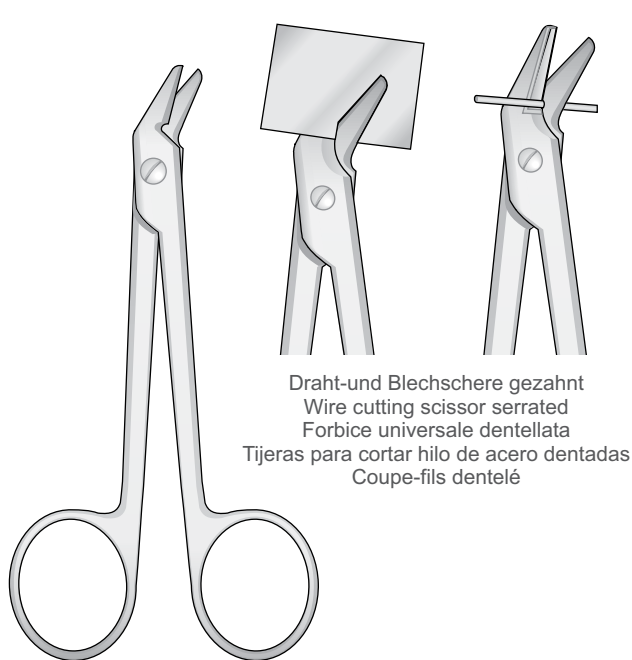

Draht- und Blechschere gezahnt
 Wire cutting scissor serrated
 Forbice universale dentellata
 Tijeras para cortar hilo de acero dentadas
 Coupe-fils dentelé

DP-90
 120 mm

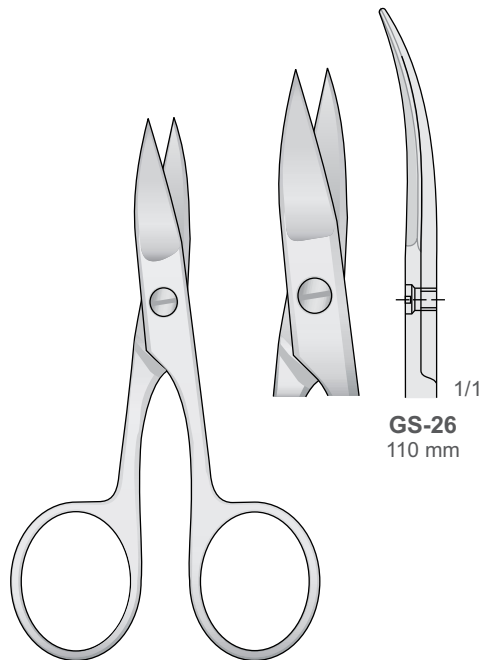

GS-26
 110 mm

GS-26
 110 mm

Spitz
 Sharp
 Acute
 Agudas
 Pointu



BEEBE
DP-91/DP-101
 110 mm

Stumpf
 Blunt
 Smusse
 Romas
 Mousse

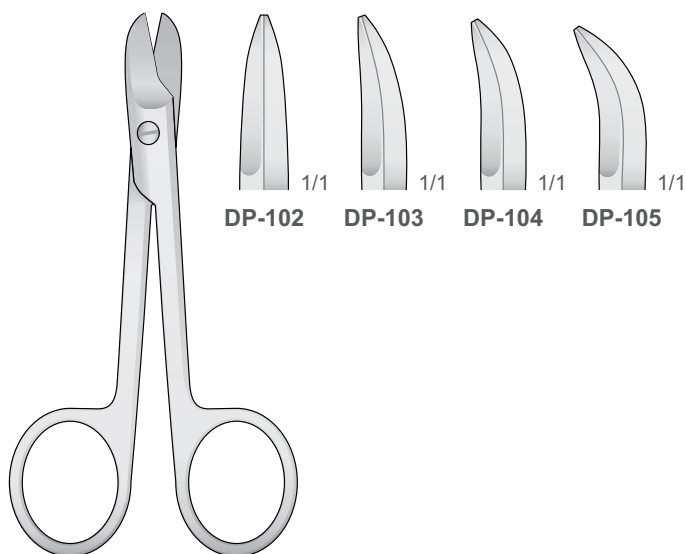

BEEBE
DP-102/DP-105
 110 mm

MSD



TWEEZERS

Delicate Forceps

Mikro Pinzetten
Micro Pinzette
Pinzas finas
Micro Pincers

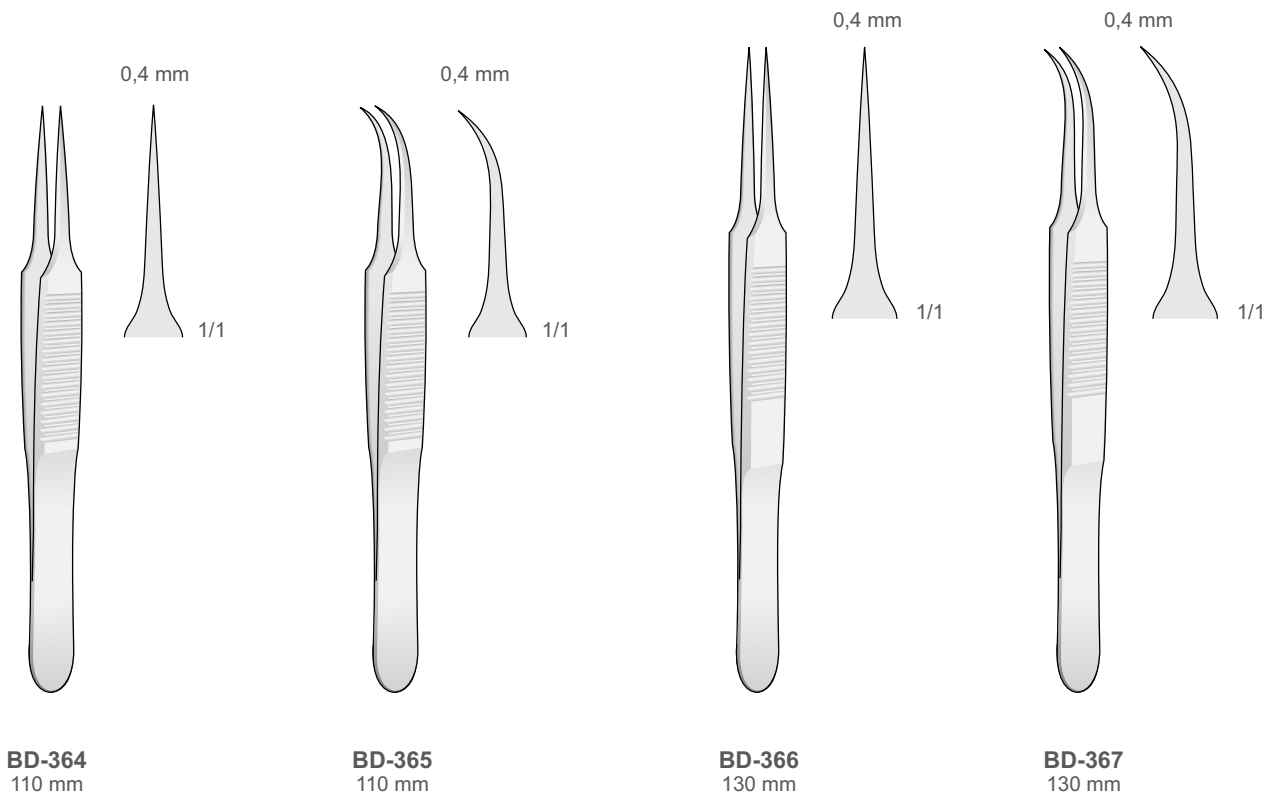
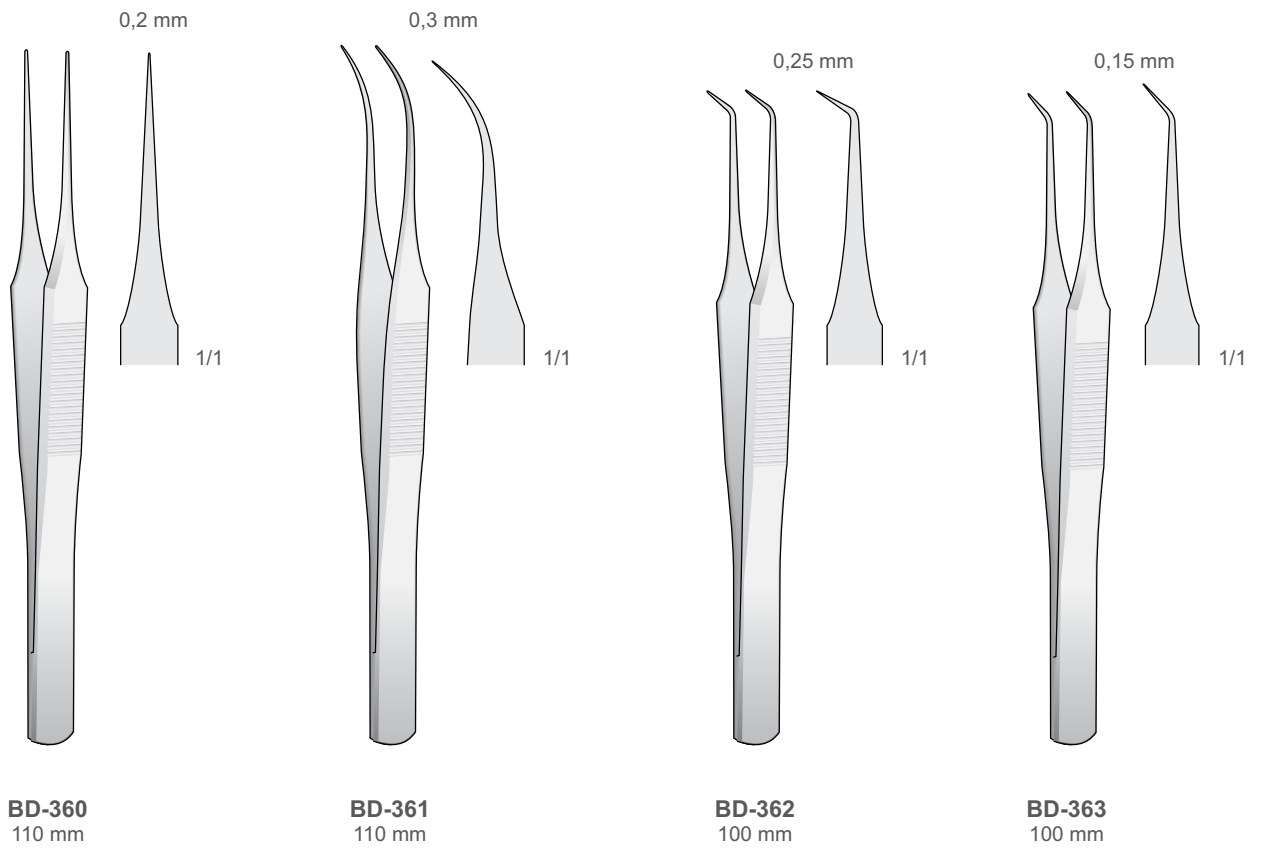

Delicate Forceps

Mikro Pinzetten
Micro Pinzette
Pinzas finas
Micro Pincas

Tweezers

Pinzette
Pince À Épiler
Pinzette
Pintset



Diamond Tip
Diamantiert
Punta diamantata
Punta de diamante
Pointe de diamant

Tissue Forceps
1x2 Teeth

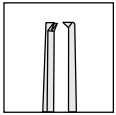

BISHOP-HARMON
MF-177 1,2 mm
85 mm

Dressing Forceps
criss-cross serrated tips

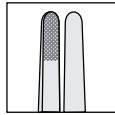

BISHOP-HARMON
MF-249 1,2 mm
85 mm

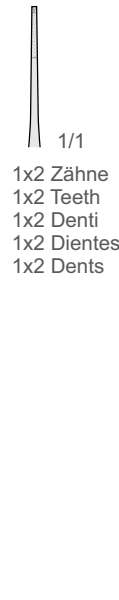

CASTROVIEJO
BD-348 0.9 mm
120 mm

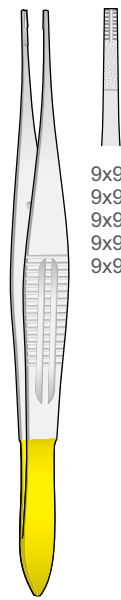

BROWN
BD-349
120 mm

1,2 mm

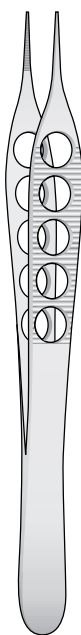

ADSON
BD-207
120 mm

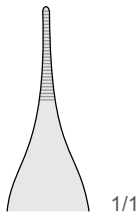

1/1

1,2 mm

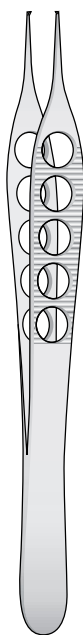

ADSON
BD-208
120 mm

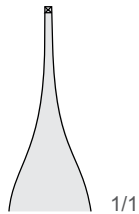

1/1

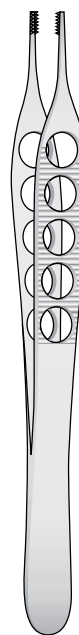

ADSON-BROWN
BD-209
120 mm

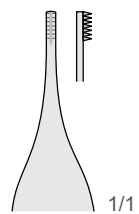

7x7 Zähne
7x7 Teeth
7x7 Denti
7x7 Dientes
7x7 Dents

TC



ADSON-BROWN
BD-253
120 mm

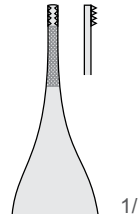

1/1

Delicate Forceps

Mikro Pinzetten
Micro Pinzette
Pinzas finas
Micro Pincers

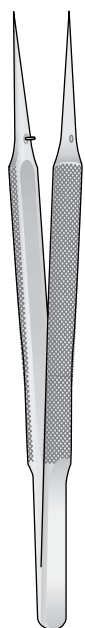
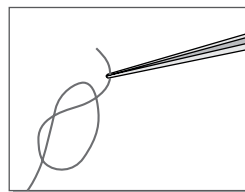

MF-110/MF-111
120 mm

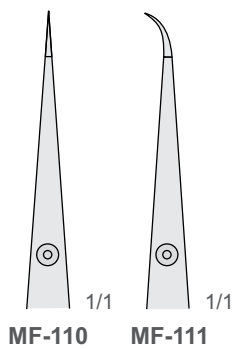

MF-110 1/1 **MF-111** 1/1

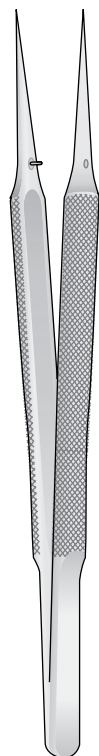

MF-112/MF-113
150 mm

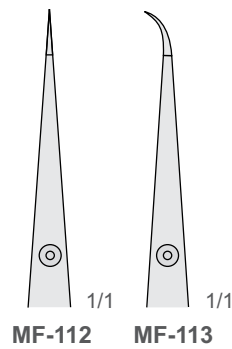

MF-112 1/1 **MF-113** 1/1

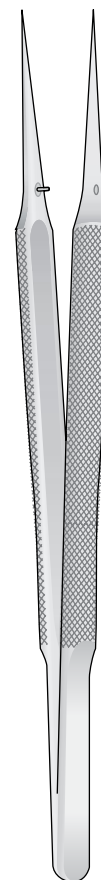

MF-114/MF-115
180 mm

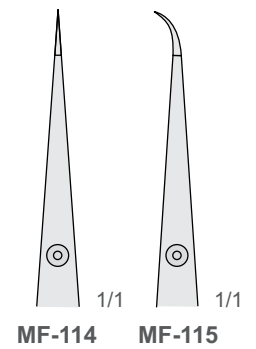

MF-114 1/1 **MF-115** 1/1

Micro Forceps

Mikro Pinzetten
Micro Pinzette
Micro Pinzas
Micro Pinces

Tweezers

Pinzette
Pince À Épiler
Pinzette
Pintset

Mikro Pinzette - Rundgriff Ø 8 mm
Mit Führungsstift diamantiert
Fadenplatte 6x0,7 mm

Micro Forceps
Micro Pinzette
Micro Pinzas
Micro Pinces

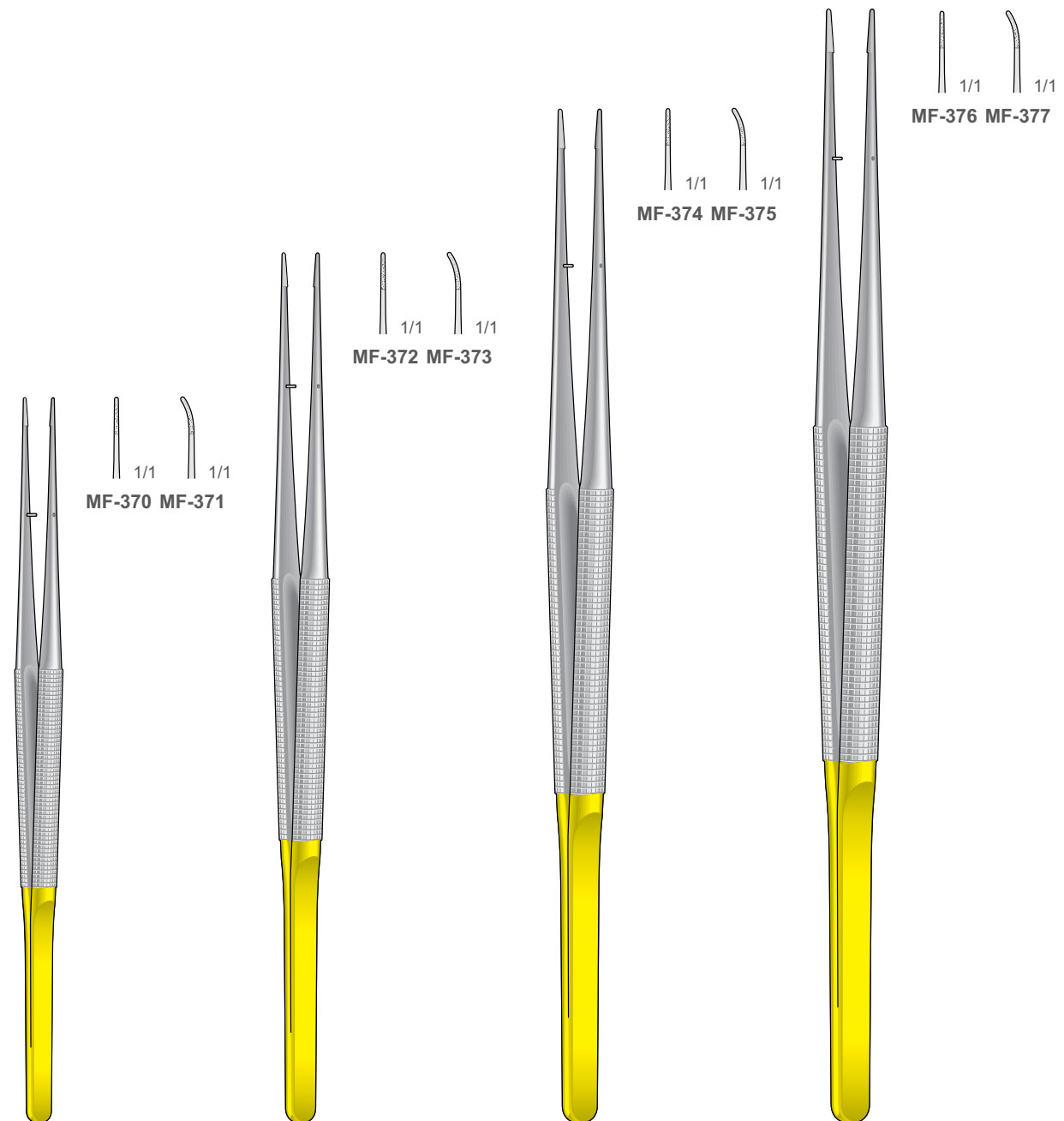

MF-370/MF-371
150 mm

MF-372/MF-373
180 mm

MF-374/MF-375
210 mm

MF-376/MF-377
230 mm

Micro Forceps

Mikro Pinzetten
 Micro Pinzette
 Micro Pinzas
 Micro Pinces

Mikro Pinzette - Rundgriff Ø 8 mm
 Mit Führungsstift diamantiert
 Fadenplatte 6x0,7 mm



<p>1x2 Zähne 1x2 Teeths 1x2 Denti 1x2 Dientes 1x2 Dents</p> <p>MF-378 MF-379</p>	<p>1x2 Zähne 1x2 Teeths 1x2 Denti 1x2 Dientes 1x2 Dents</p> <p>MF-380 MF-381</p>	<p>1x2 Zähne 1x2 Teeths 1x2 Denti 1x2 Dientes 1x2 Dents</p> <p>MF-382 MF-383</p>	<p>1x2 Zähne 1x2 Teeths 1x2 Denti 1x2 Dientes 1x2 Dents</p> <p>MF-384 MF-385</p>
<p>MF-378/MF-379 150 mm</p>	<p>MF-380/MF-381 180 mm</p>	<p>MF-382/MF-383 210 mm</p>	<p>MF-384/MF-385 230 mm</p>

Titanium Tissue Forceps

Titan-Pinzetten
Pinzette in titanio
Pinzas de titanio
Pincas en titane

Tweezers

Pinzette
Pince À Épiler
Pinzette
Pintset

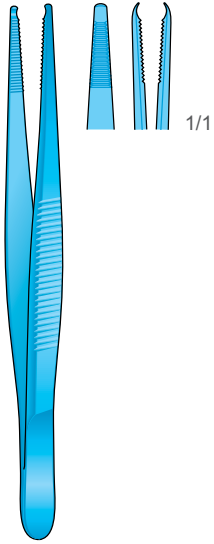

BD-285T
90 mm

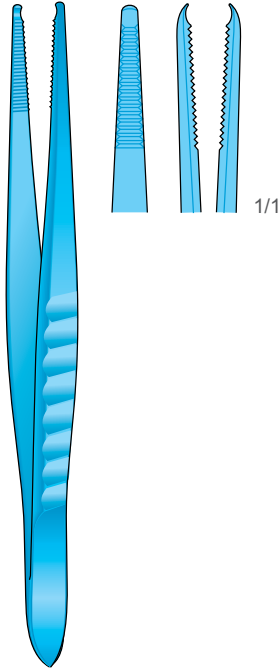

BD-270T
130 mm

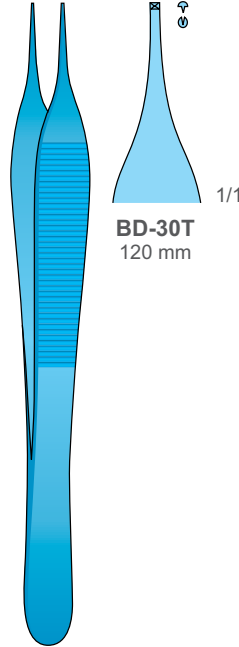

ADSON
BD-30T
120 mm

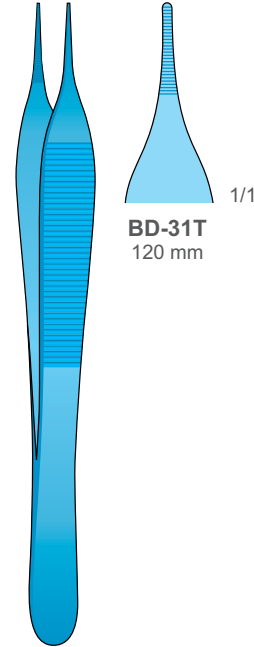

ADSON
BD-31T
120 mm

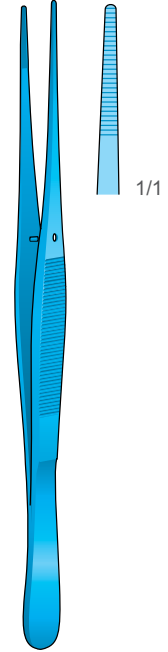

BD-09T
130 mm

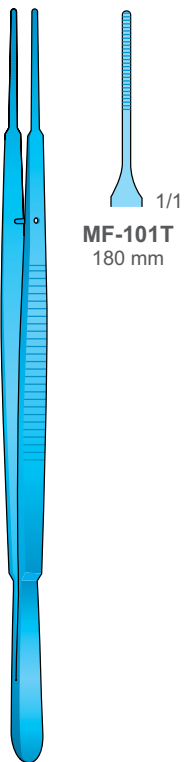

GERALD
MF-101T/MF-102T
180 mm

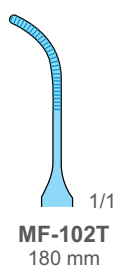

MF-102T
180 mm

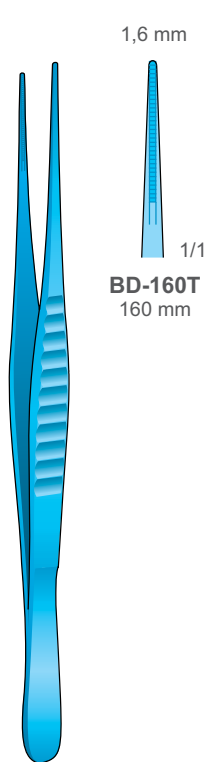

DE BAKEY
BD-80T/BD-160T

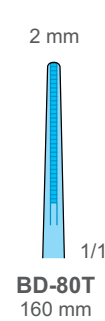

1,6 mm
BD-160T
160 mm

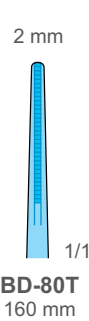

2 mm
BD-80T
160 mm



COLLEGE
TT-01
150 mm

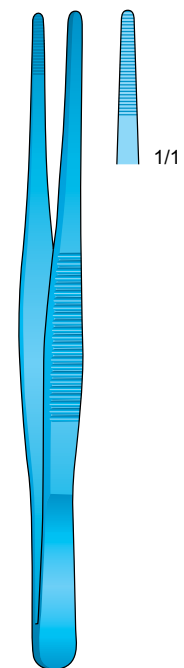

BD-75T
145 mm

Delicate Forceps

Mikro Pinzetten
Micro Pinzette
Pinzas finas
Micro Pinces

Rund-Griffe Ø 8 mm
Round handle Ø 8 mm
Manico rotondo Ø 8 mm
Mango redondo Ø 8 mm
Manche rond Ø 8 mm

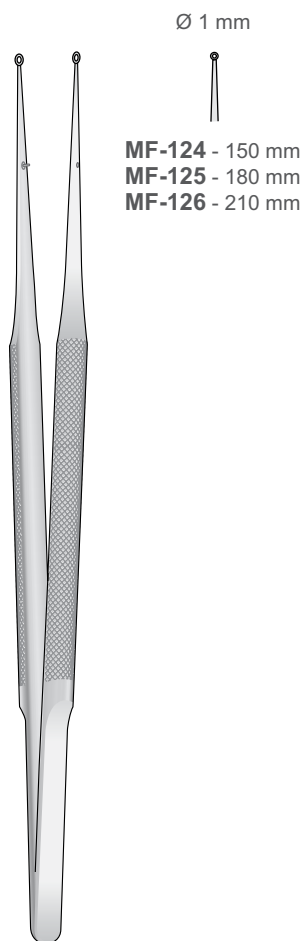

MF-124/MF-129

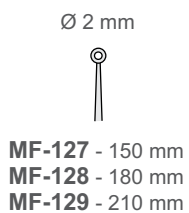

Titan
Titanium
Titanio
Titane

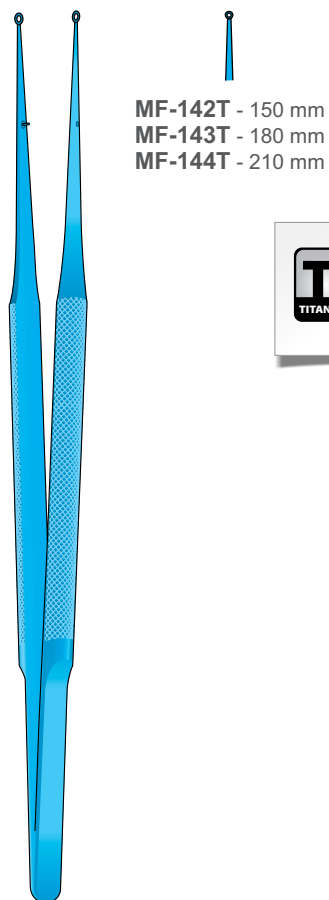

MF-142T/MF-147T

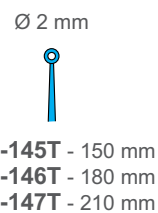

Cotton and Dressing Pliers

Zahnpinzetten
 Pinzette per medicazione
 Pinzas para vendajes
 Précelles pour coton

Tweezers

Pinzette
 Pince À Épiler
 Pinzette
 Pintset

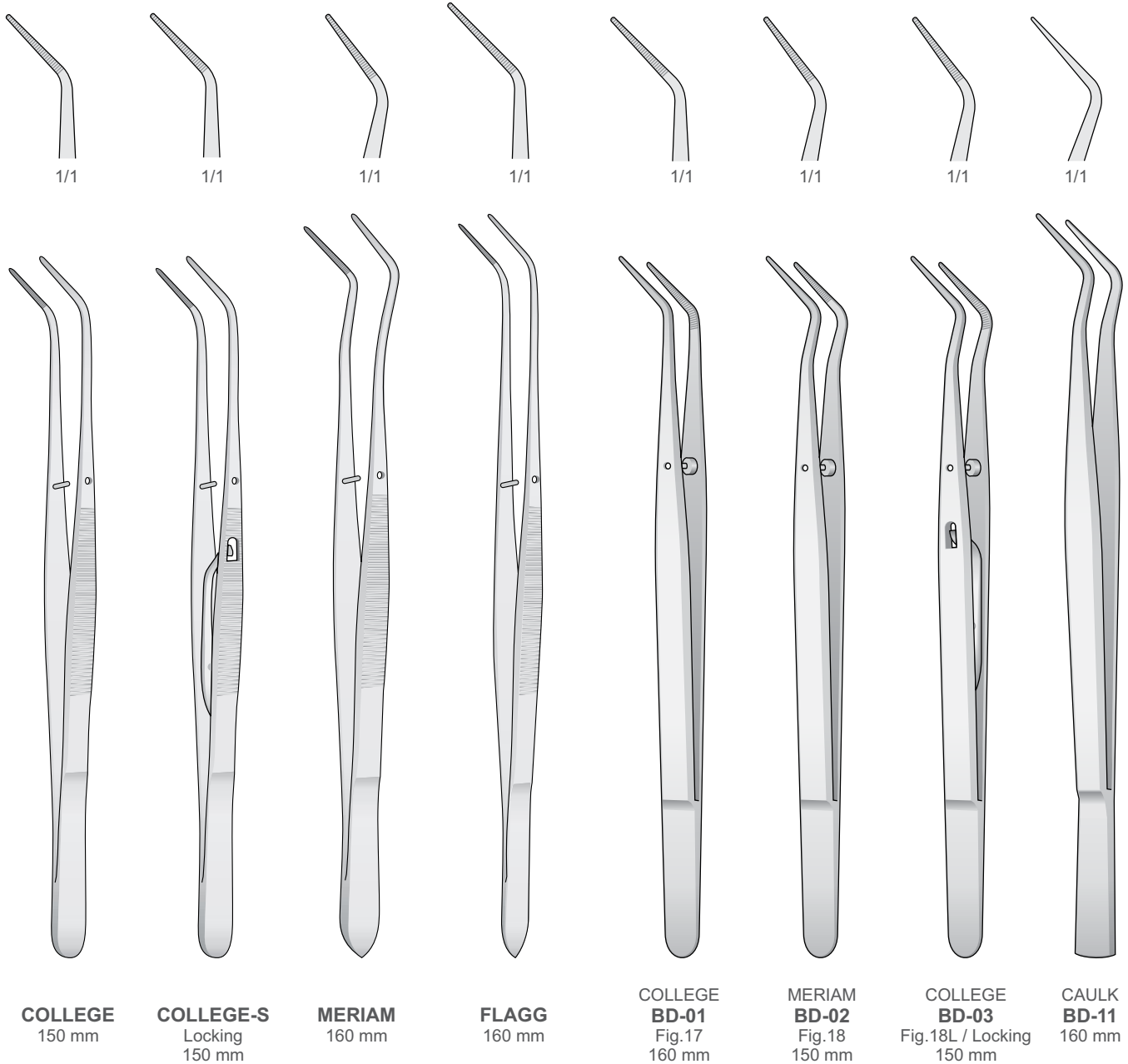

Endodontic Forceps

Pinzette für Endodontie
Pinzette per endodonzia
Pinzas para endodoncia
Pinces pour endodontie

Endo Forceps

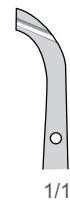
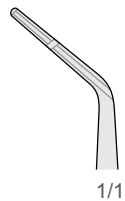
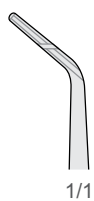
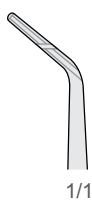

DA-04
Endo
150 mm

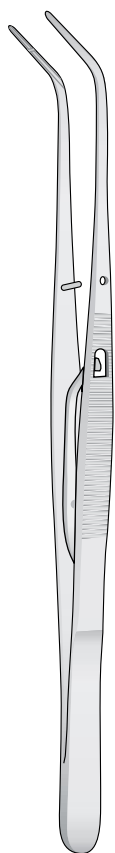

DA-05
Endo / Locking
150 mm

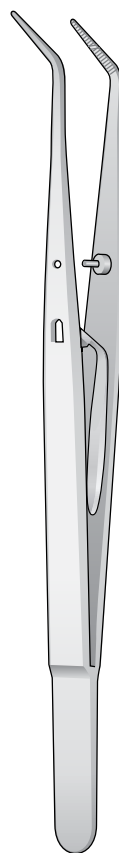

DA-09
Endo / Locking
150 mm



DA-11
Endo / Locking
155 mm

Tissue and Dressing Forceps

Chirurgische und Anatomische Pinzetten
 Pinzette anatomiche e chirurgiche
 Pinzas de diseccion y chirùrgicas
 Pincas anatomiques chirurgicales

Tweezers

Pinzette
 Pince À Épiler
 Pinzette
 Pintset

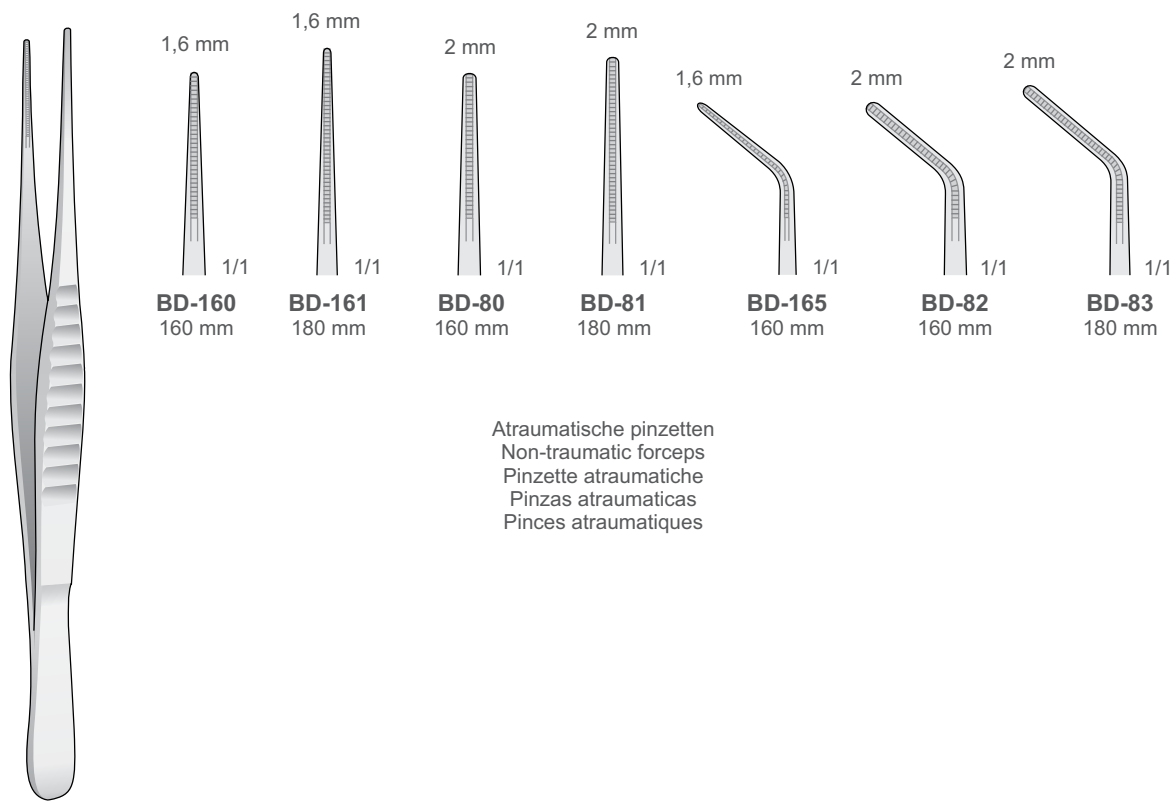

Atraumatische pinzetten
 Non-traumatic forceps
 Pinzette atraumatiche
 Pinzas atraumaticas
 Pincas atraumatiques

DE BAKEY
 BD-80/BD-165

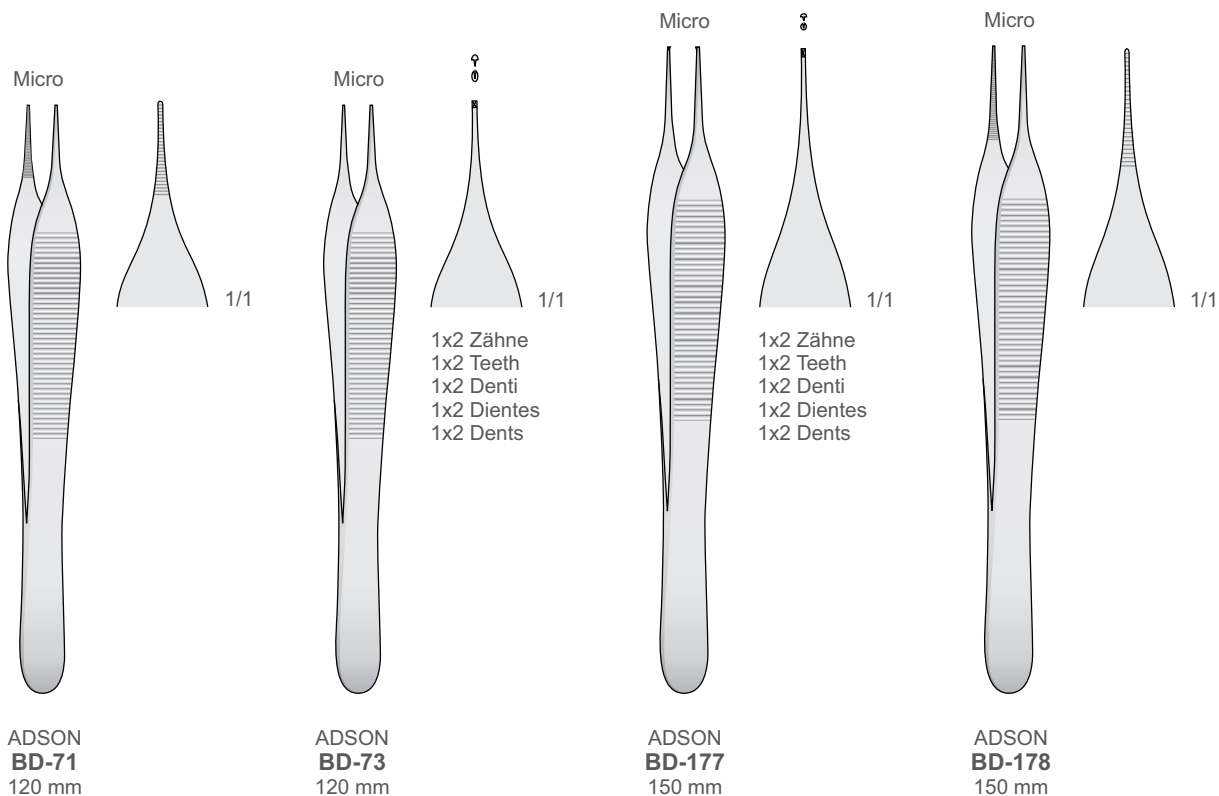

ADSON
 BD-71
 120 mm

ADSON
 BD-73
 120 mm

ADSON
 BD-177
 150 mm

ADSON
 BD-178
 150 mm

Tissue Forceps

Chirurgische Pinzetten
Pinzette chirurgiche
Pinzas quirùrgicas
Pincas quirurgicales

Taschenmarkierungspinzetten
Pocket markers
Pinzette segnatasche
Pinzas para marcar el sulco periodontal
Pincas à marquer la poche

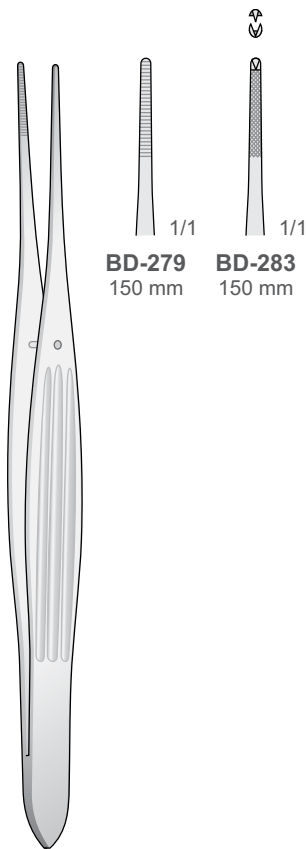

BD-279
150 mm

BD-283
150 mm

McINDOE
BD-279/BD-283
150 mm

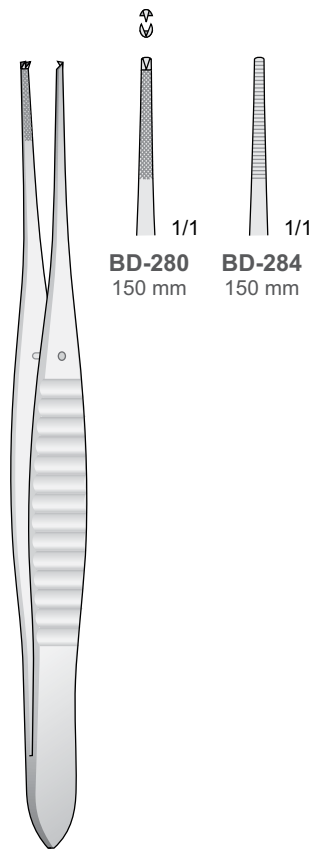

BD-280
150 mm

BD-284
150 mm

GILLIES
BD-280/BD-284
150 mm

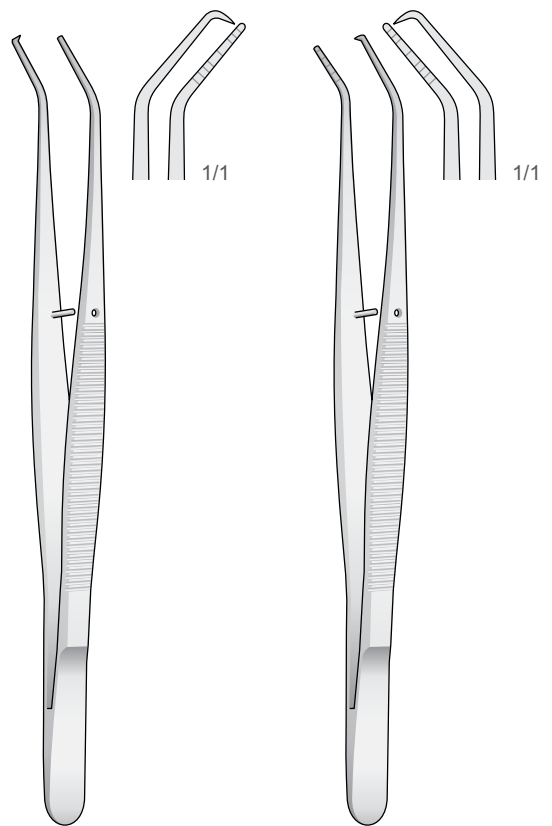

CRANE-CAPLAN
DB-01
150 mm

CRANE-CAPLAN
DB-02
150 mm

Tissue Forceps

Chirurgische Pinzetten
Pinzette chirurgiche
Pinzas chirùrgicas
Pincas chirùrgicas

Tweezers

Pinzette
Pince À Épiler
Pinzette
Pintset

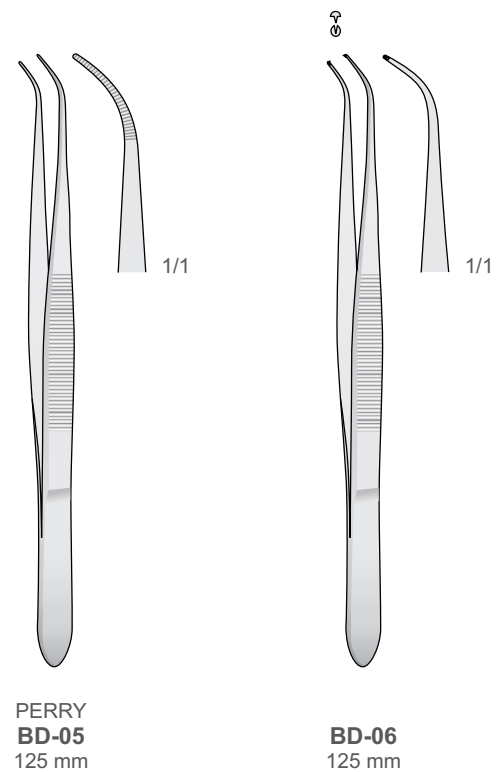
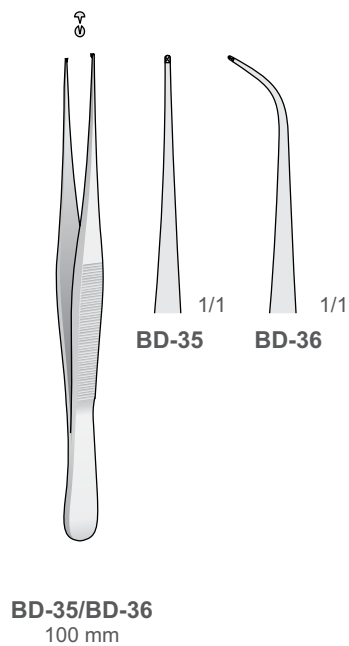
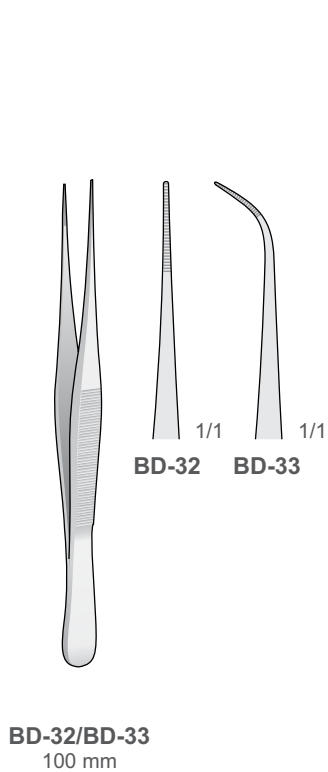
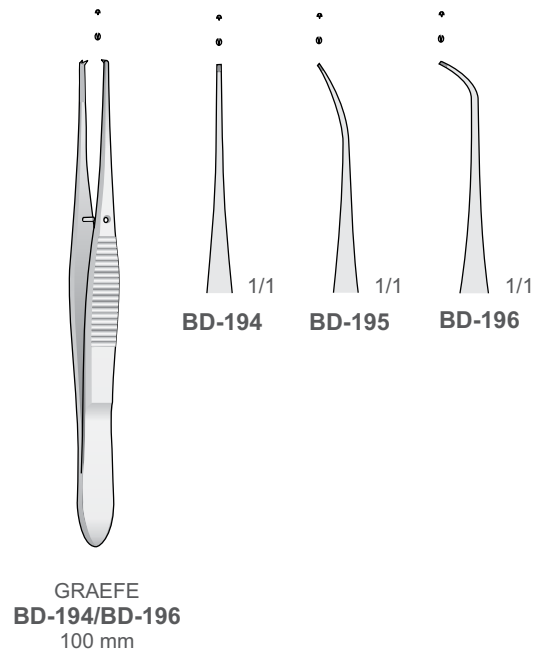
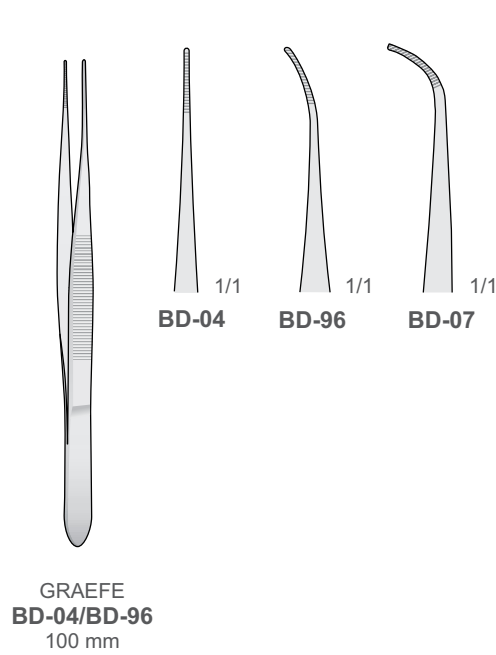

Dressing Forceps

Anatomische Pinzetten
 Pinzette anatomiche
 Pinzas de diseccion
 Pincas anatomiques



BD-270
 130 mm

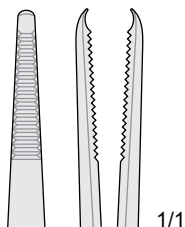

BD-145
 130 mm



BD-16
 160 mm

BD-148
 160 mm

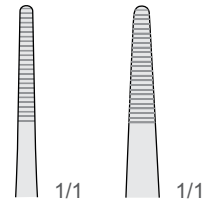

BD-10/BD-76



BD-10
 145 mm

BD-75
 145 mm

BD-76
 200 mm



BD-97/BD-99

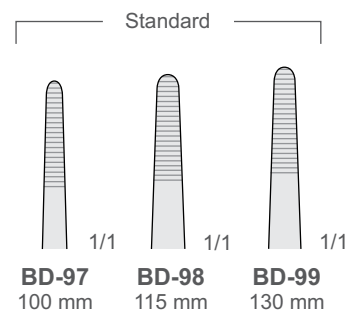

BD-97
 100 mm

BD-98
 115 mm

BD-99
 130 mm

Tissue Forceps

Chirurgische Pinzetten
 Pinzette chirurgiche
 Pinzas quirùrgicas
 Pincas quirùrgicas

Tweezers

Pinzette
 Pince À Épiler
 Pinzette
 Pintset

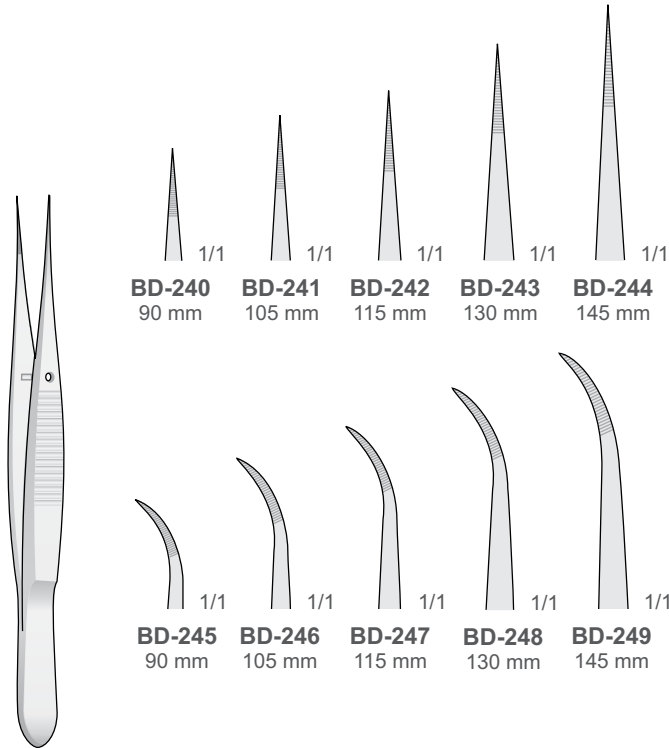

BD-240/BD-249

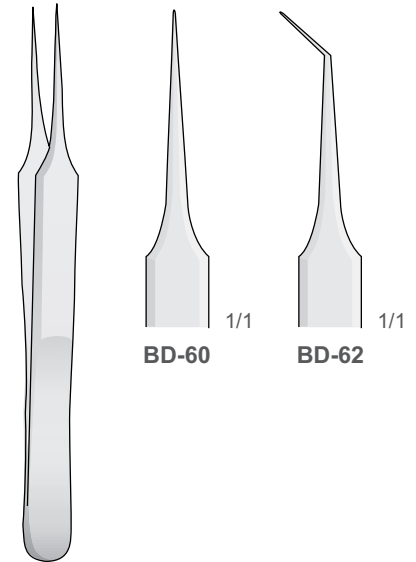

BD-60/BD-62
110 mm

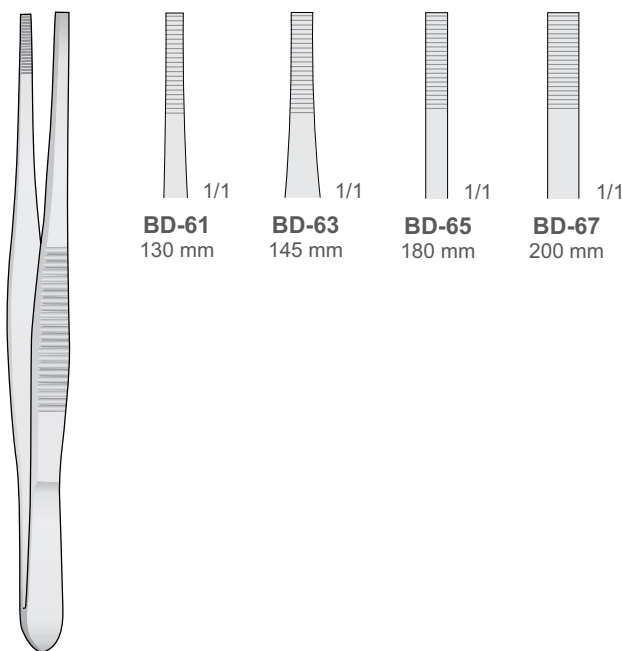

STILLE
BD-61/BD-67

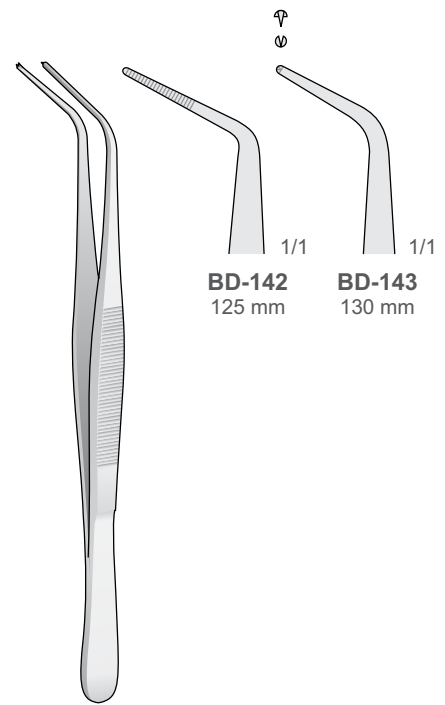

BD-142/BD-143

Tissue Forceps

Chirurgische Pinzetten
 Pinzette chirurgiche
 Pinzas quirúrgicas
 Pincas quirúrgicas

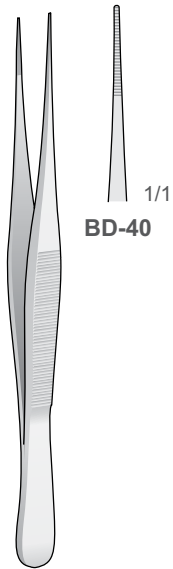

BD-40

BD-40
 110 mm

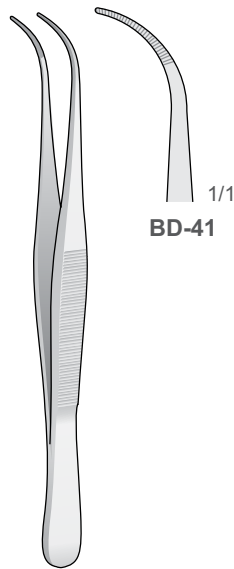

BD-41

BD-41
 110 mm

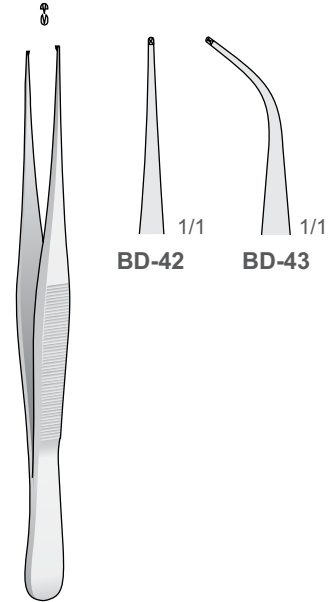

BD-42

BD-43

BD-42/BD-43
 110 mm

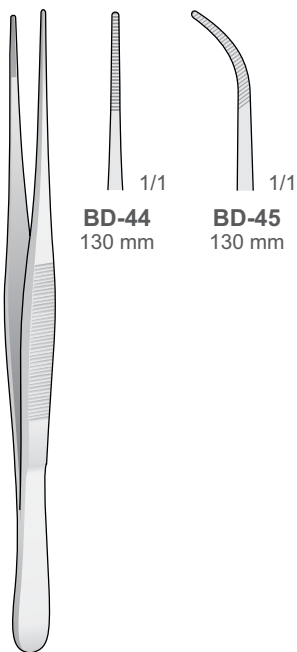

BD-44

BD-45

SEMKEN
BD-44/BD-45
 130 mm

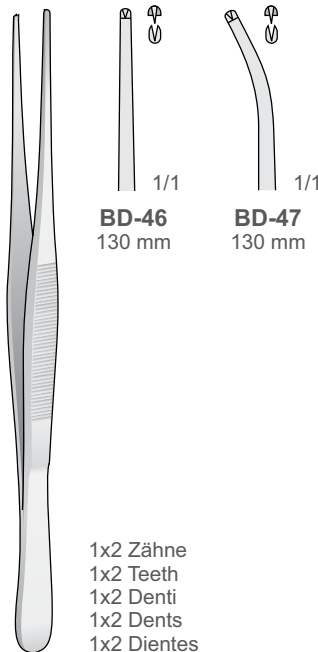

BD-46

BD-47

1x2 Zähne
 1x2 Teeth
 1x2 Denti
 1x2 Dents
 1x2 Dientes

SEMKEN
BD-46/BD-47
 130 mm

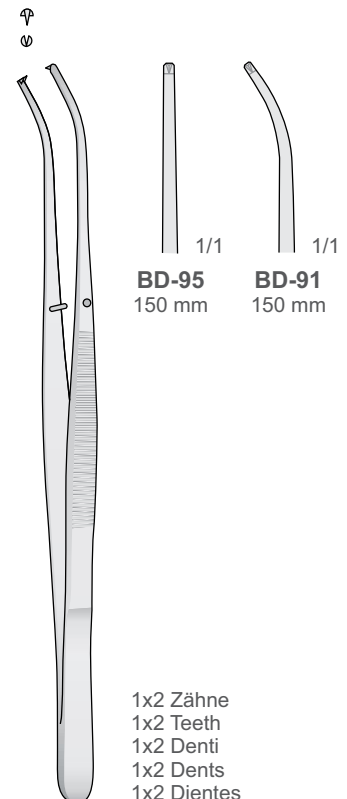

BD-95

BD-91

150 mm

150 mm

SEMKEN
BD-91/BD-95
 150 mm

1x2 Zähne
 1x2 Teeth
 1x2 Denti
 1x2 Dents
 1x2 Dientes

Tissue Forceps

Chirurgische Pinzetten
Pinzette chirurgische
Pinzas quirúrgicas
Pincas quirúrgicas

Tweezers

Pinzette
Pince À Épiler
Pinzette
Pintset

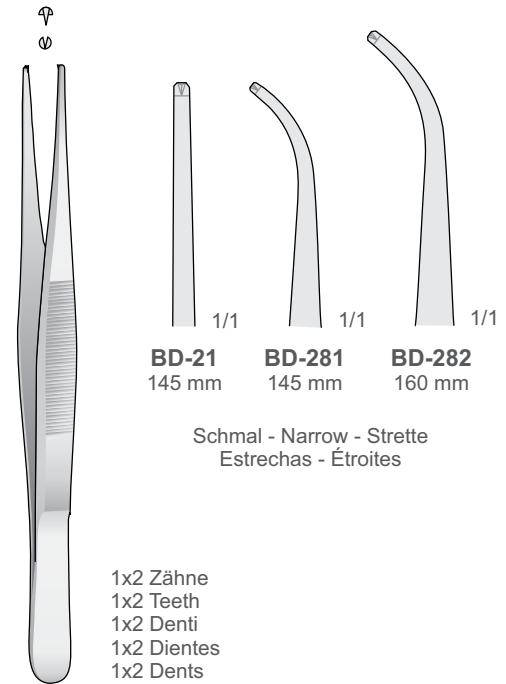
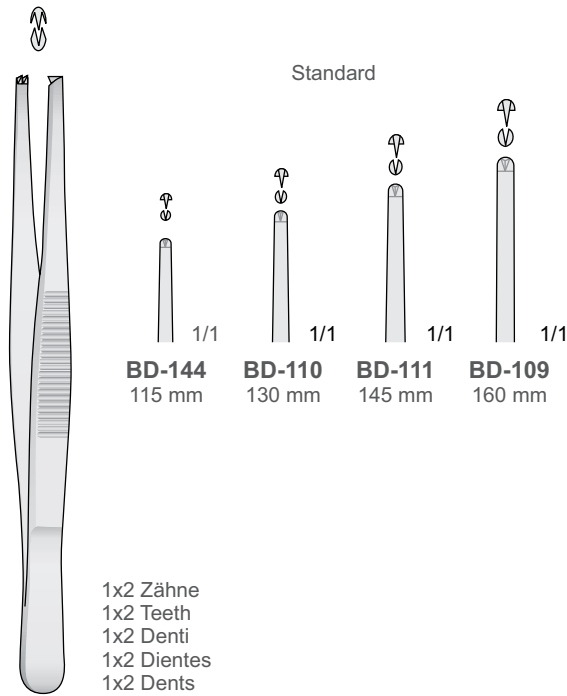

BD-109/BD-144

BD-21/BD-282

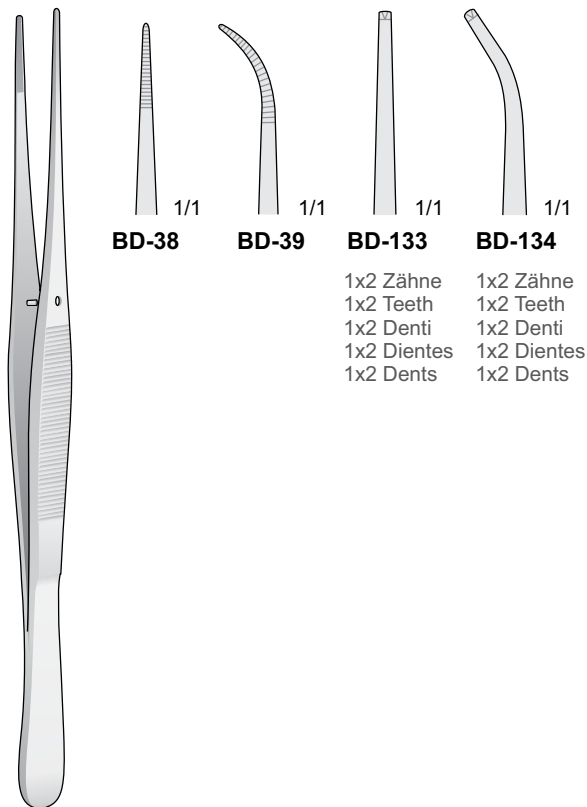

BD-38/BD-134
200 mm

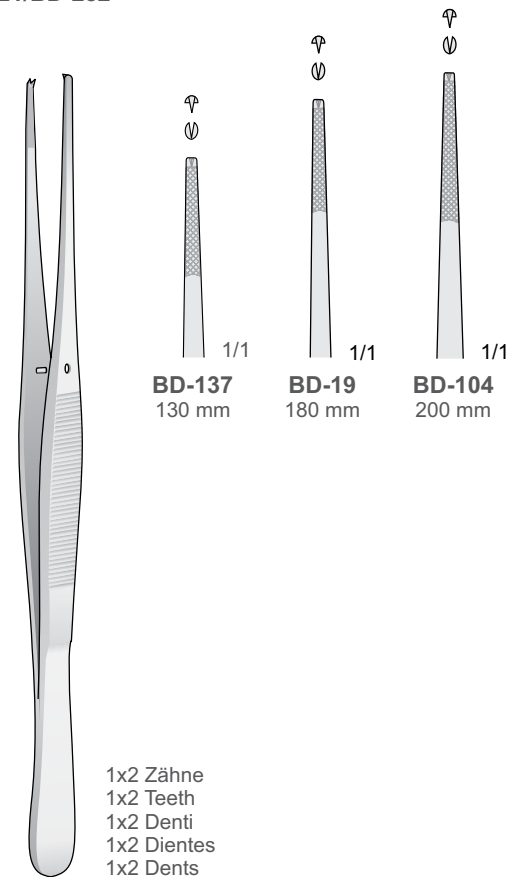

BD-19/BD-137

Tissue Forceps

Chirurgische Pinzetten

Pinzette chirurgiche

Pinzas quirùrgicas

Pinces quirurgicales

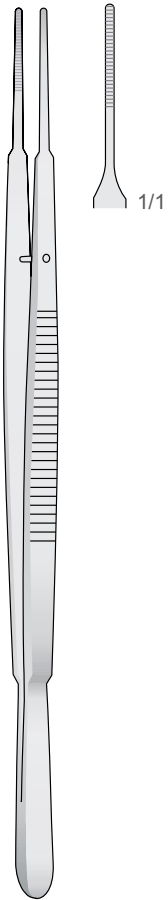

GERALD
MF-101
180 mm

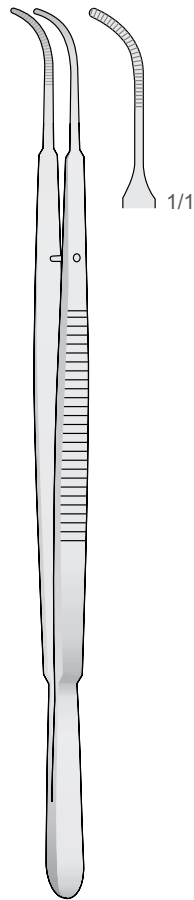

GERALD
MF-102
180 mm

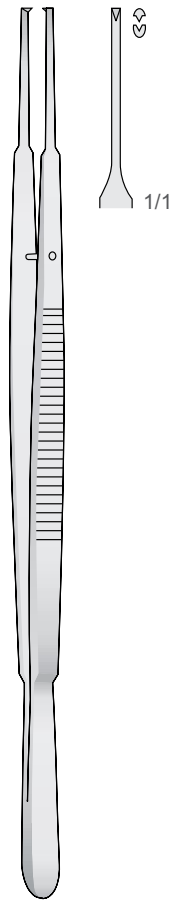

GERALD
MF-103
180 mm

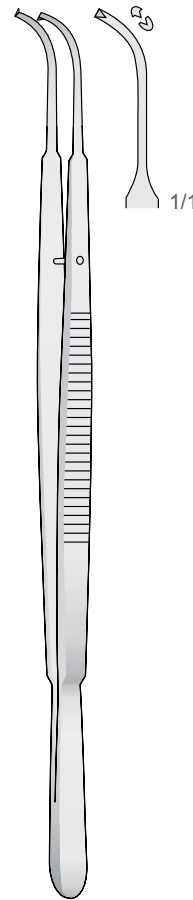

GERALD
MF-104
180 mm

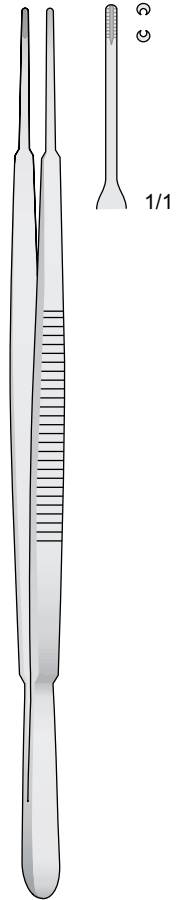

GERALD-BROWN
MF-105
180 mm

Tissue Forceps

Chirurgische Pinzetten
Pinzette chirurgiche
Pinzas quirùrgicas
Pincas quirurgicas

Tweezers

Pinzette
Pince À Épiler
Pinzette
Pintset

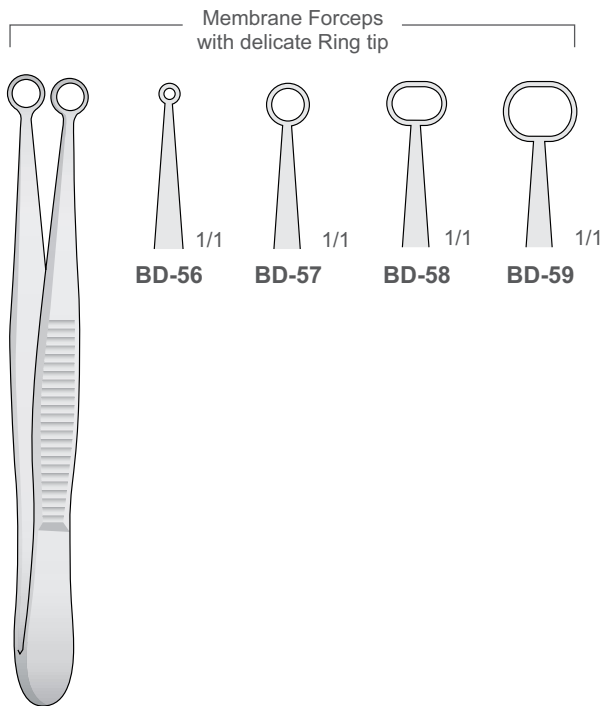

BD-56/BD-59
100 mm

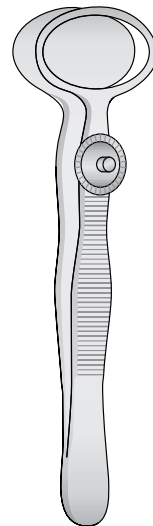

DESMARRES
BD-130/BD-131
90 mm

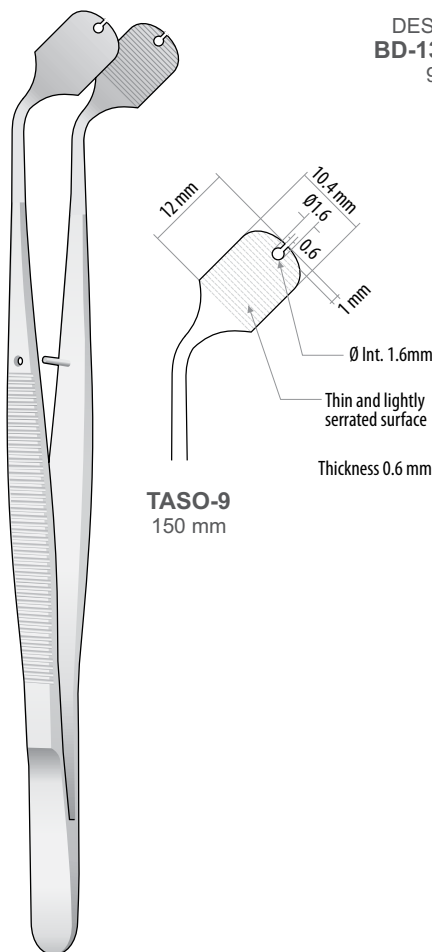
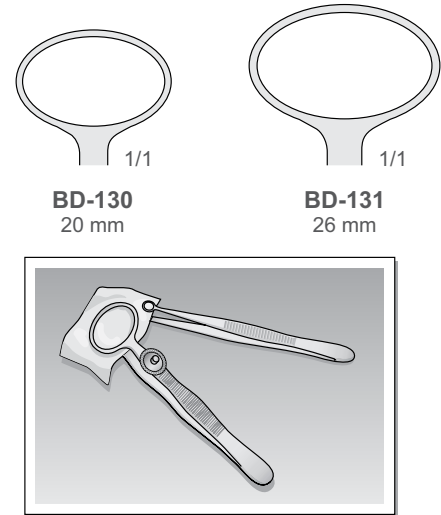

TASO-9
150 mm

Pinzetten zum Halten Membranen
Membrane Holding forceps
Pinza per fissaggio membrane
Pinza para sostener membranas
Pince pour le maintien membranes

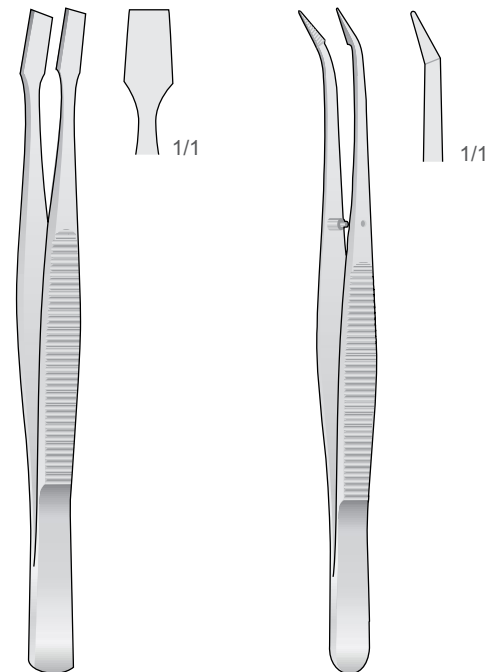

KÜHNE
ES-44
105 mm

BARRAQUER
ES-65
105 mm

Tissue Forceps

Chirurgische Pinzetten
Pinzette chirurgische
Pinzas quirúrgicas
Pincas quirúrgicas

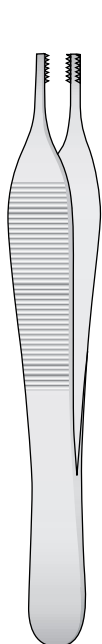

ADSON-BROWN
BD-92/BD-141
120 mm

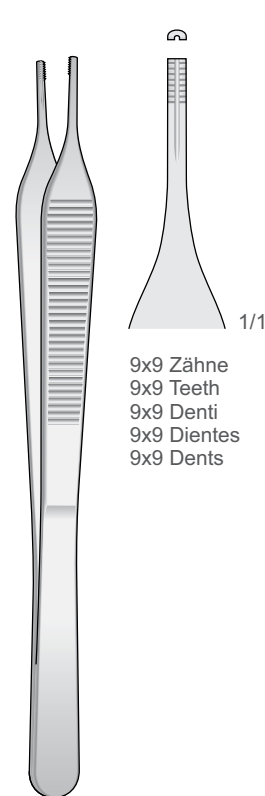
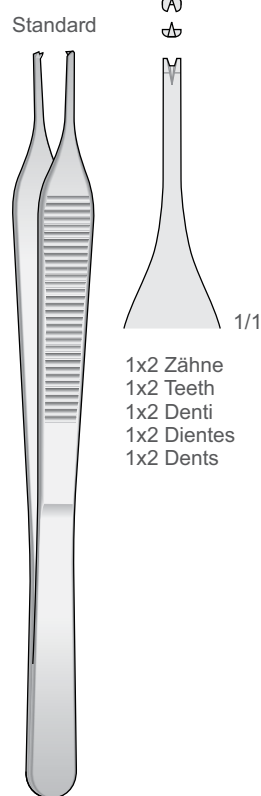
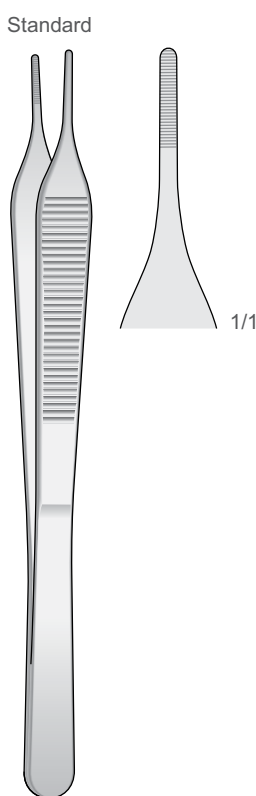
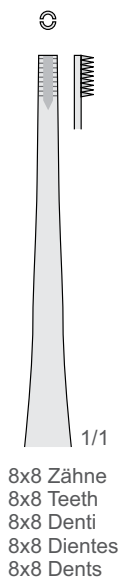
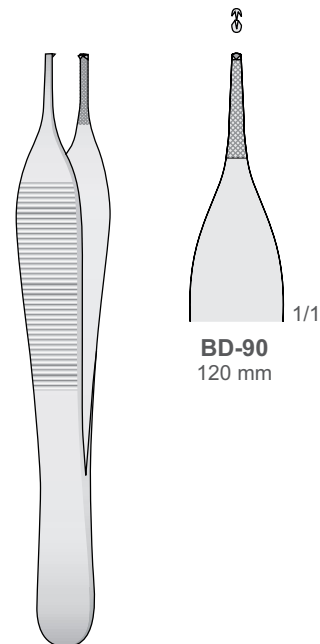
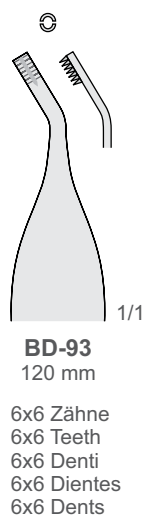
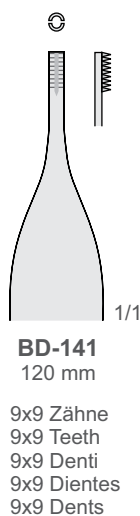
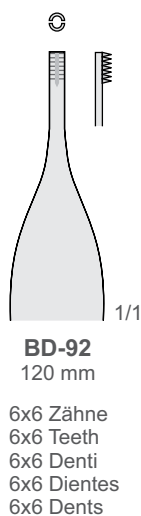

Tissue Forceps

Chirurgische Pinzetten
Pinzette chirurgiche
Pinzas quirùrgicas
Pincas quirurgicales

Tweezers

Pinzette
Pince À Épiler
Pinzette
Pintset

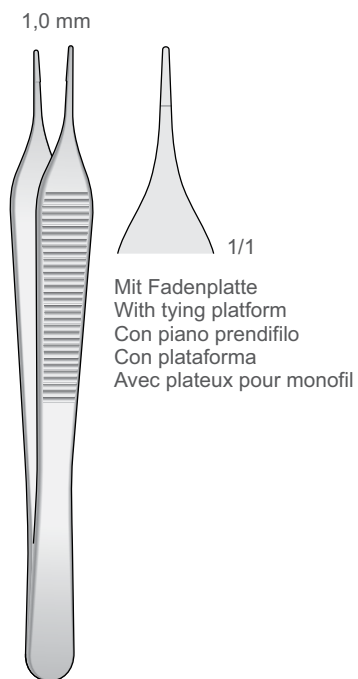

Mit Fadenplatte
With tying platform
Con piano prendifilo
Con plataforma
Avec plateau pour monofil

ADSON
BD-370
120 mm

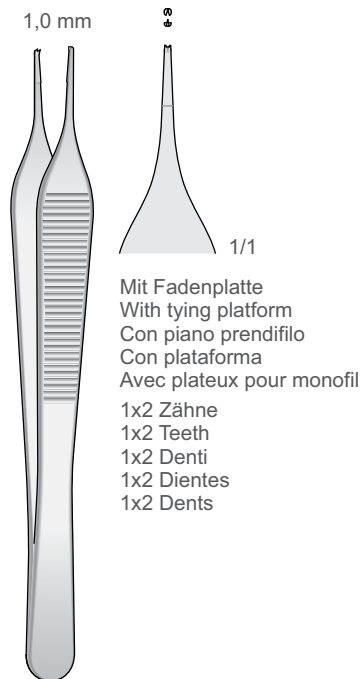

Mit Fadenplatte
With tying platform
Con piano prendifilo
Con plataforma
Avec plateau pour monofil
1x2 Zähne
1x2 Teeth
1x2 Denti
1x2 Dientes
1x2 Dents

ADSON
BD-371
120 mm

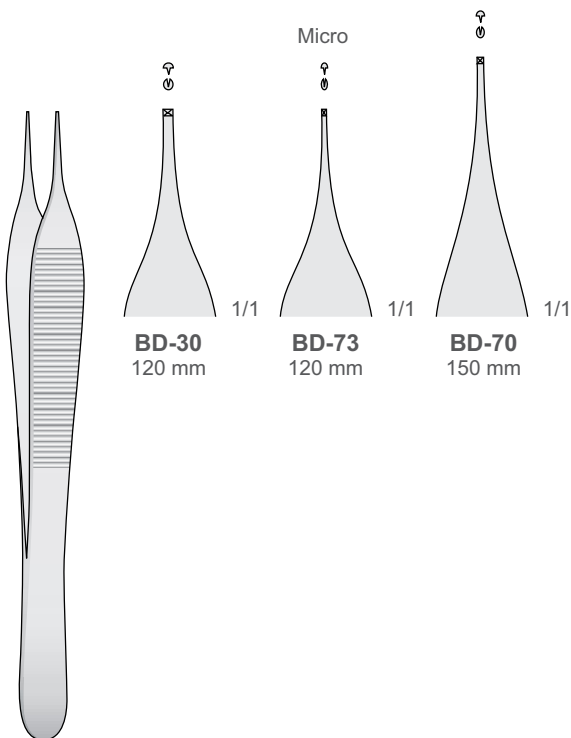

BD-30
120 mm

BD-73
120 mm

BD-70
150 mm

ADSON
BD-30/BD-73

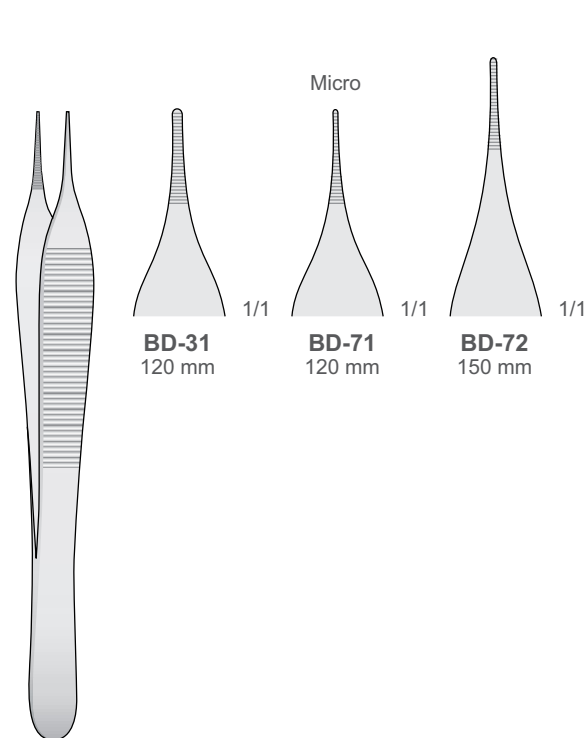

BD-31
120 mm

BD-71
120 mm

BD-72
150 mm

ADSON
BD-31/BD-72

Tissue Forceps - Dressing forceps

Chirurgische Pinzetten - Anatomische Pinzetten
 Pinzette chirurgische - Pinzette anatomiche
 Pinzas quirúrgicas - Pinzas de diseccion
 Pincas chirurgicales - Pincas anatomiques

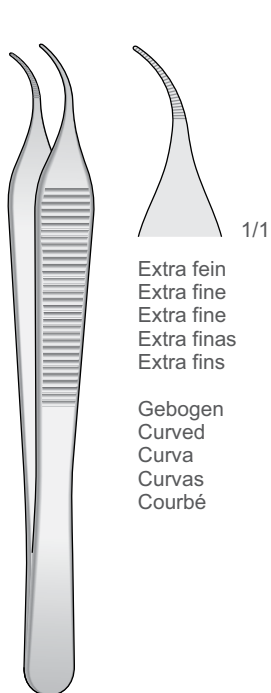

Extra fein
 Extra fine
 Extra fine
 Extra finas
 Extra fins

Gebogen
 Curved
 Curva
 Curvas
 Courbé

MICRO-ADSON
BD-372
 120 mm

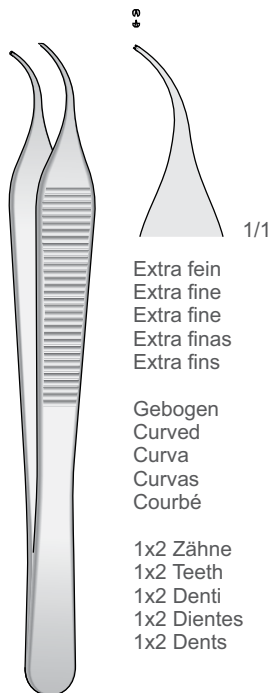

Extra fein
 Extra fine
 Extra fine
 Extra finas
 Extra fins

Gebogen
 Curved
 Curva
 Curvas
 Courbé

1x2 Zähne
 1x2 Teeth
 1x2 Denti
 1x2 Dientes
 1x2 Dents

MICRO-ADSON
BD-373
 120 mm

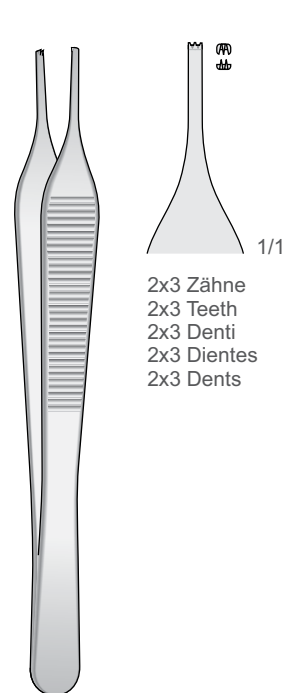

2x3 Zähne
 2x3 Teeth
 2x3 Denti
 2x3 Dientes
 2x3 Dents

ADSON
BD-377
 120 mm

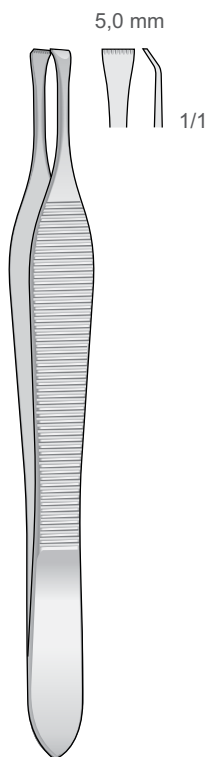

BEASLEY-BABCOCK
BD-51
 120 mm

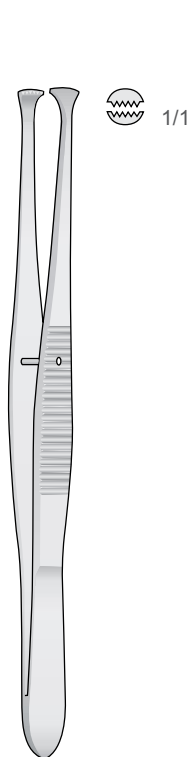

GRAEFE
BD-135
 110 mm

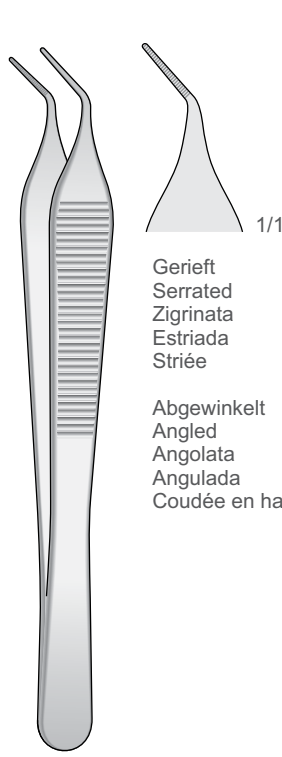

Gerieft
 Serrated
 Zigrinata
 Estriada
 Striée

Abgewinkelt
 Angled
 Angolata
 Angulada
 Coudée en haut

ADSON
BD-378
 120 mm

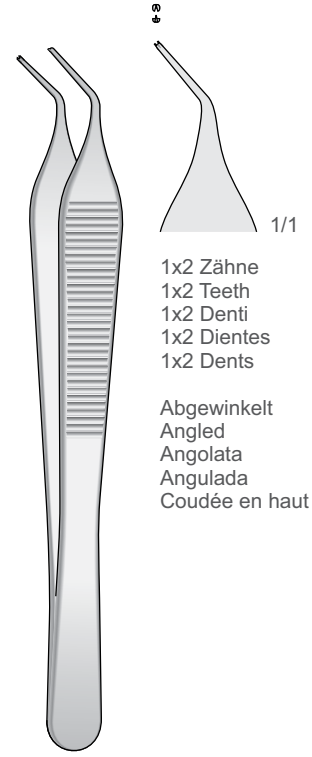

1x2 Zähne
 1x2 Teeth
 1x2 Denti
 1x2 Dientes
 1x2 Dents

Abgewinkelt
 Angled
 Angolata
 Angulada
 Coudée en haut

ADSON
BD-379
 120 mm

Tissue Forceps - Dressing forceps

Chirurgische Pinzetten - Anatomische Pinzetten
 Pinzette chirurgische - Pinzette anatomiche
 Pinzas quirùrgicas - Pinzas de diseccion
 Pincas quirurgicales - Pincas anatomiques

Tweezers

Pinzette
 Pince À Épiler
 Pinzette
 Pintset

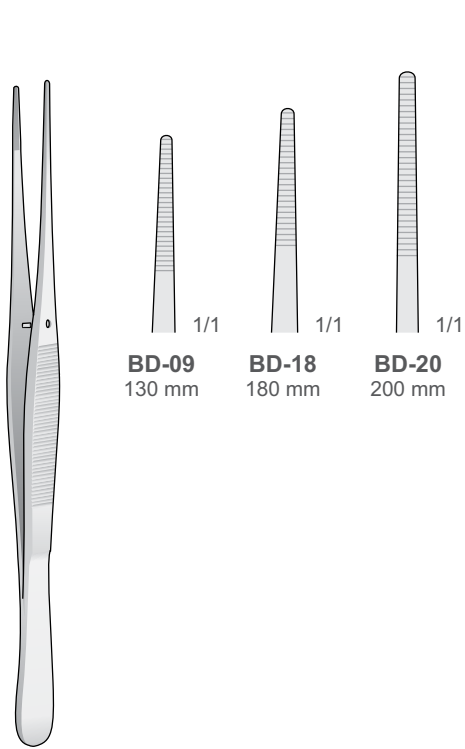

BD-09
130 mm

BD-18
180 mm

BD-20
200 mm

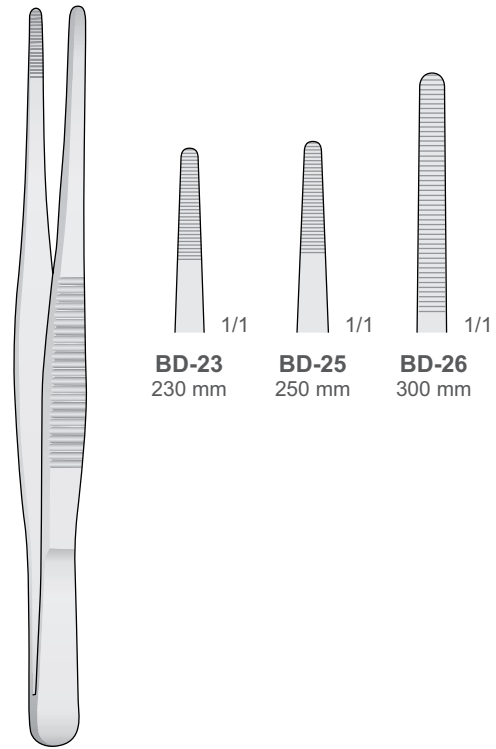

BD-23
230 mm

BD-25
250 mm

BD-26
300 mm

BD-09/BD-20

BD-23/BD-26



1x2 Zähne
 1x2 Teeth
 1x2 Denti
 1x2 Dientes
 1x2 Dents

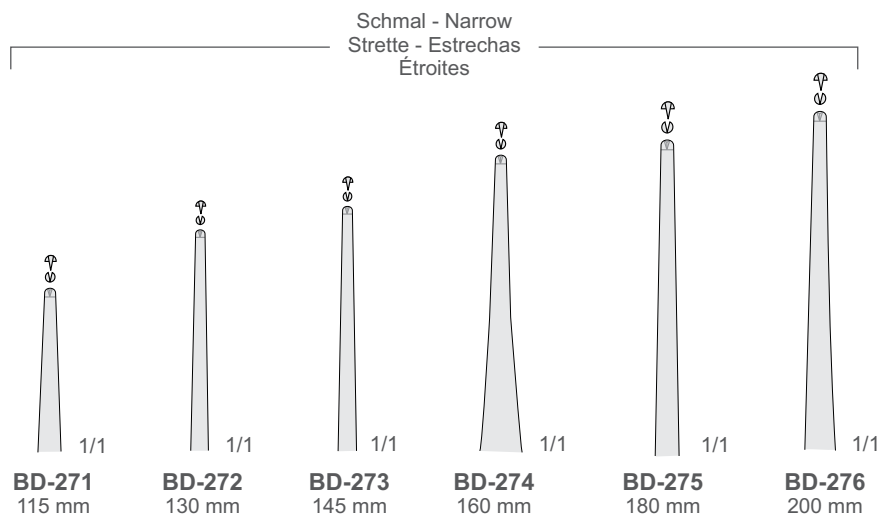

BD-271
115 mm

BD-272
130 mm

BD-273
145 mm

BD-274
160 mm

BD-275
180 mm

BD-276
200 mm

BD-271/BD-276

Tissue Forceps

Chirurgische Pinzetten
 Pinzette chirurgiche
 Pinzas quirùrgicas
 Pincas quirurgicales

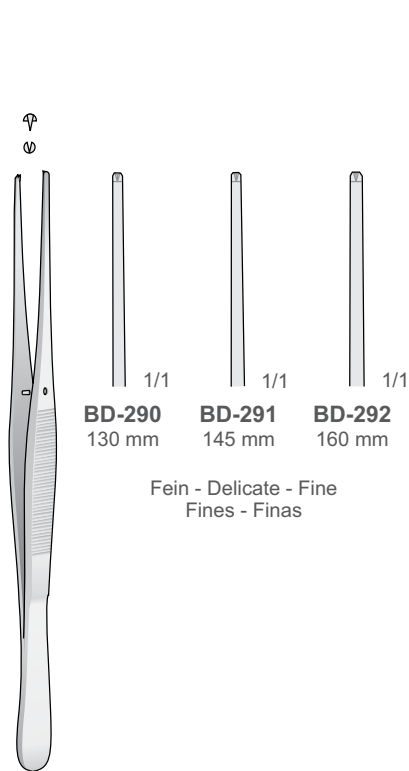

BD-290 130 mm
BD-291 145 mm
BD-292 160 mm

Fein - Delicate - Fine
 Fines - Finas

BD-290/BD-292

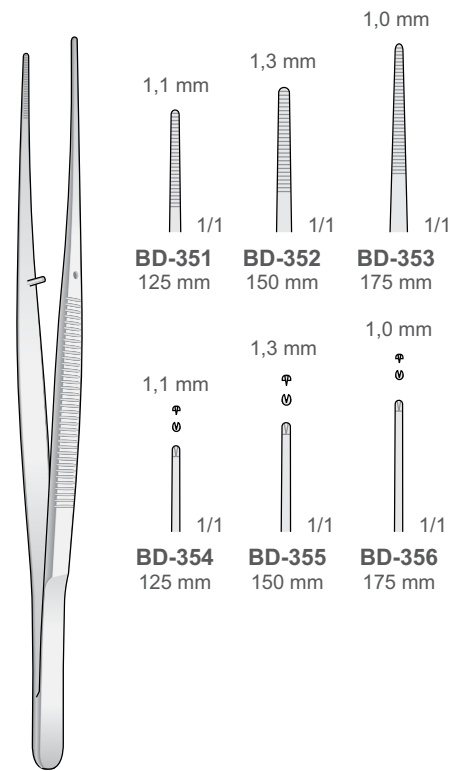

BD-351 125 mm
BD-352 150 mm
BD-353 175 mm

BD-354 125 mm
BD-355 150 mm
BD-356 175 mm

BD-351/BD-356

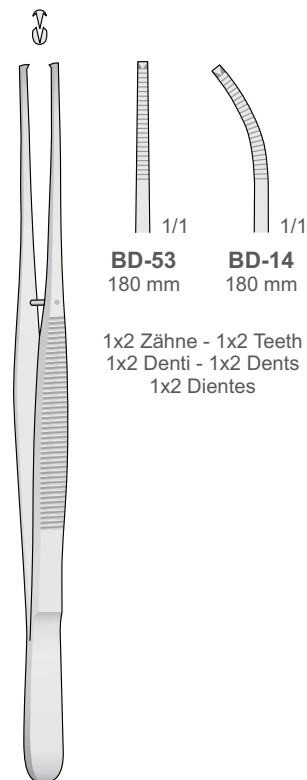

BD-53 180 mm
BD-14 180 mm

1x2 Zähne - 1x2 Teeth
 1x2 Denti - 1x2 Dents
 1x2 Dientes

POTTS-SMITH
BD-14/BD-53
 180 mm

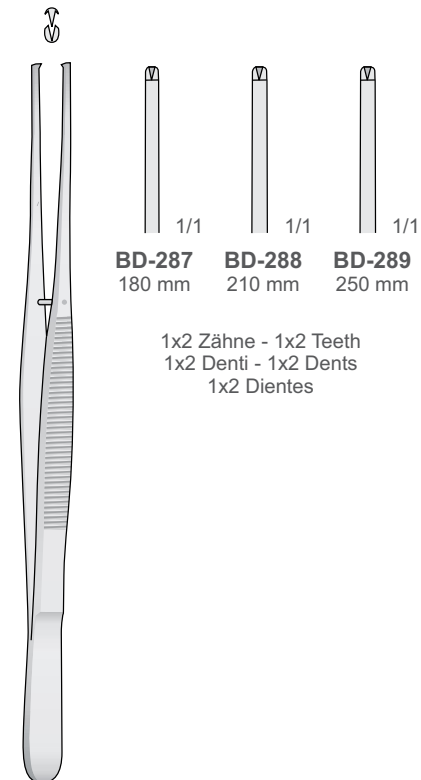

BD-287 180 mm
BD-288 210 mm
BD-289 250 mm

1x2 Zähne - 1x2 Teeth
 1x2 Denti - 1x2 Dents
 1x2 Dientes

POTTS-SMITH
BD-287/BD-289

Tissue Forceps, Non-traumatic Forceps

Chirurgische Pinzetten, Atraumatische Pinzetten
 Pinzette chirurgische, Pinzette atraumatice
 Pinzas quirùrgicas, Pinzas atraumàticas
 Pincas chirurgicales, Pincas atraumatiques

Tweezers

Pinzette
 Pince À Épiler
 Pinzette
 Pintset

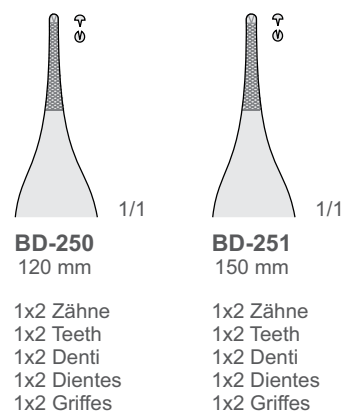
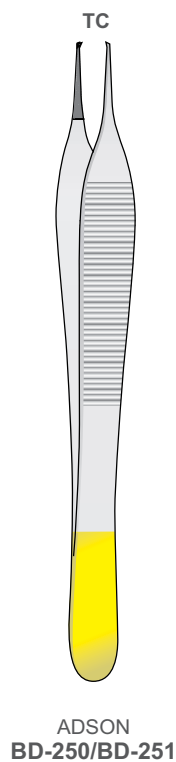
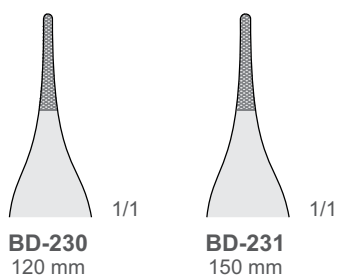
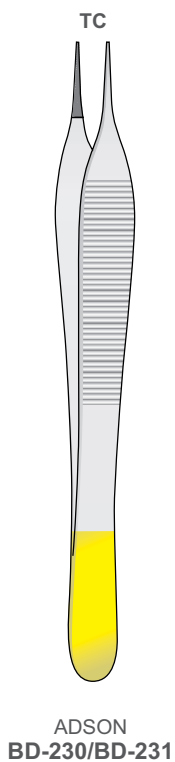
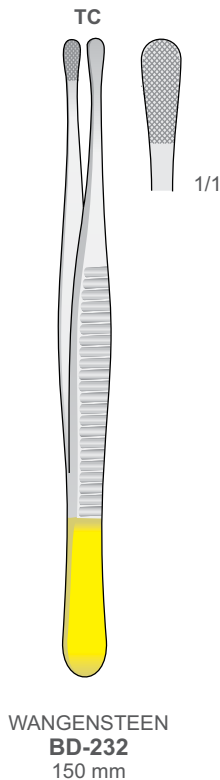
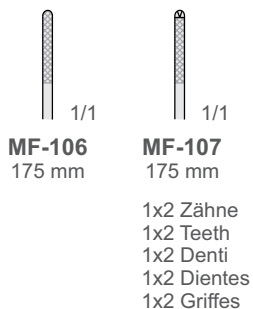
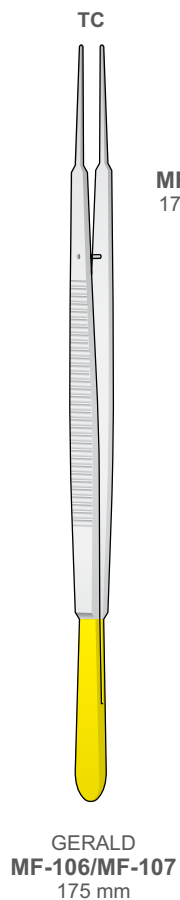

Tissue Forceps, Non-traumatic Forceps

Chirurgische Pinzetten, Atraumatische Pinzetten
 Pinzette chirurgische, Pinzette atraumatiche
 Pinzas quirùrgicas, Pinzas atraumàticas
 Pincès chirurgicales, Pincès atraumatiques



BD-210/BD-213

Standard

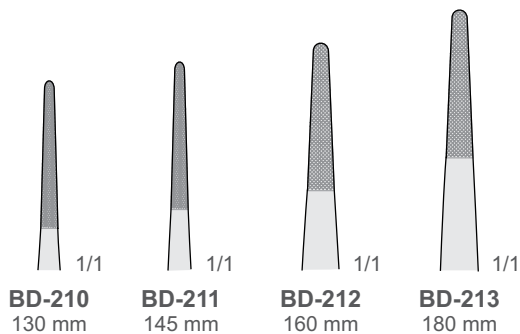

TC
TUNGSTEN
CARBIDE
Tungsten-Carbide Inserts
 Mit Hartmetalleinsätzen
 Plaquettes en carbure de tungstène
 Plaquetas de carburo de tungsteno
 Inserti in carburo di tungsteno



SEMKEN
 BD-216/BD-217

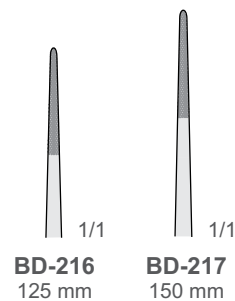

BD-221/BD-224

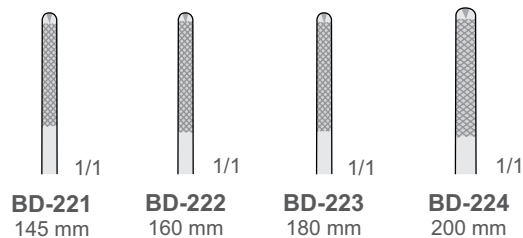

TC

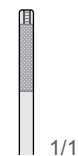

Mikroprofil
 Micro profile
 Profilo micro
 Perfil micro
 Profil micro
 2.0 mm

DE BAKEY
 BD-267
 160 mm

Tissue Forceps, Non-traumatic Forceps

Chirurgische Pinzetten, Atraumatische Pinzetten
 Pinzette chirurgiche, Pinzette atraumatiche
 Pinzas quirùrgicas, Pinzas atraumàticas
 Pincès chirurgicales, Pincès atraumatiques

Tweezers

Pinzette
 Pince À Épiler
 Pinzette
 Pintset

Naht-und Membranpinzette - Suture and membrane Forceps Pinzette per suture e membrane - Pinzas para suturas y membranas Pincettes à suture et à membrane

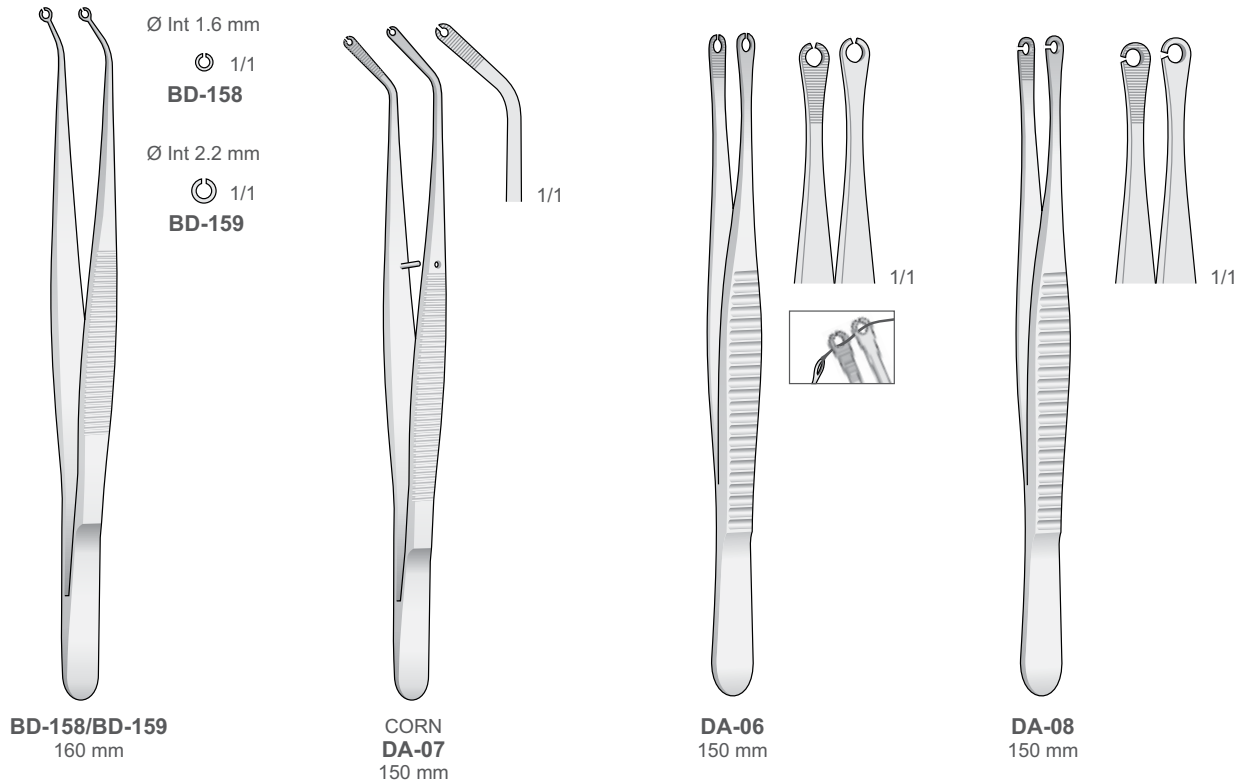

Artikulationspapier-Pinzetten - Articulating Paper Forceps Pinza per carta articolazione - Pinzas para papel de articular Pince pour papier à articuler

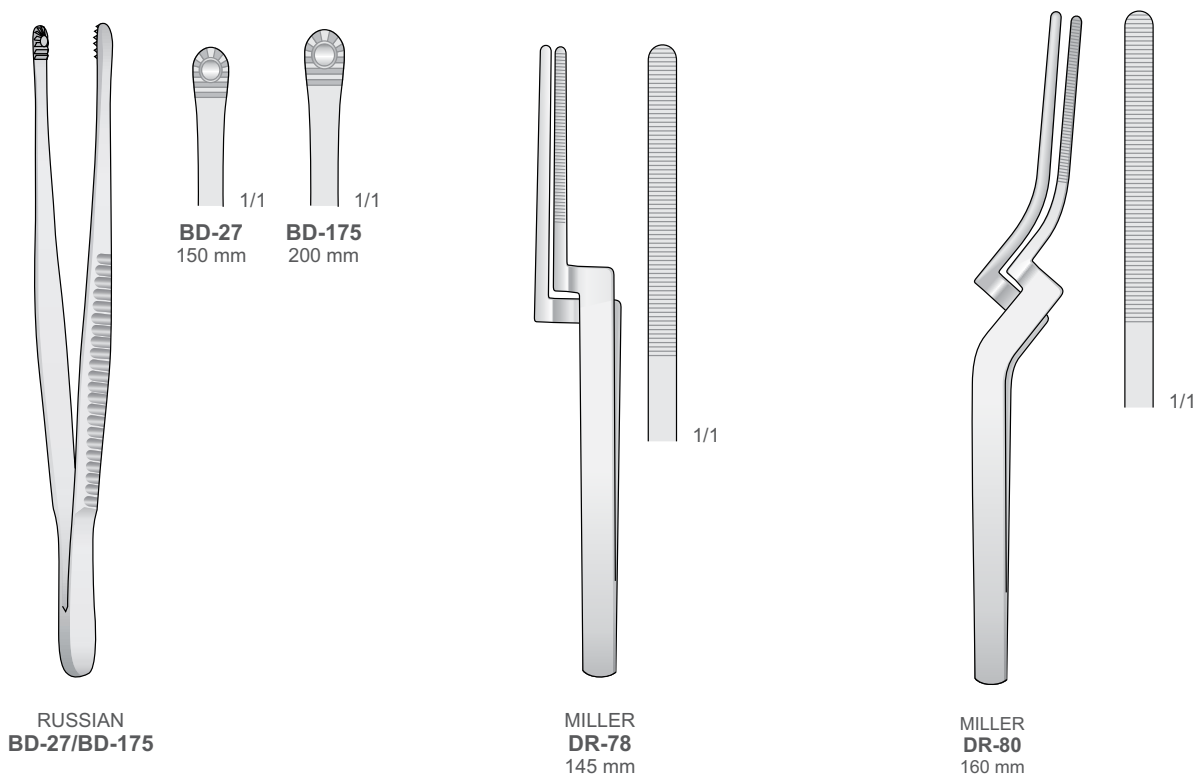

MSD

DRIVERS



Needle Holders

Nadelhalter
Port'aghi
Portaagujas
Porte aiguilles

Drivers

Treiber
Conductrices
Autiste
Drayvery

Mit Scheren
With Scissor
Con forbice
Con tijeras
Avec ciseaux

Glattes Maul
Smooth Jaw
Morso liscio
Mandibula lisa
Mors lisse

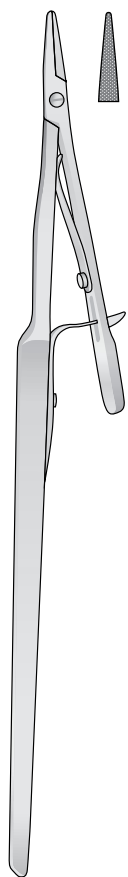

1/1

STEVENS
FD-38
160 mm

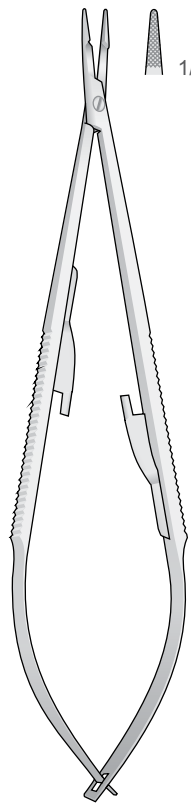

1/1

FD-26
140 mm

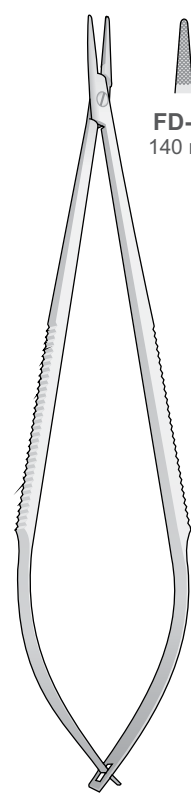

1/1

FD-14
140 mm

1/1

FD-16
140 mm

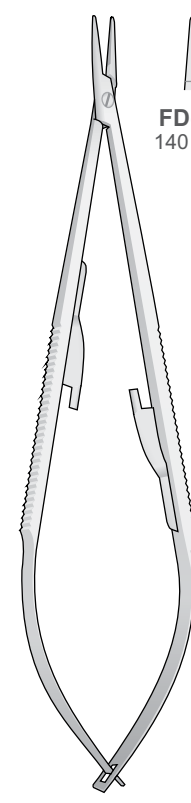

1/1

FD-17
140 mm

1/1

FD-19
140 mm

CASTROVIEJO
FD-17/FD-19
140 mm

Needle Holders

Nadelhalter
Port'aghi
Portaagujas
Porte aiguilles

Mit Locking-System
With Locking System (stop)
Con sistema di bloccaggio
Con sistema de bloqueo
Avec système de verrouillage

Glattes Maul
Smooth Jaw
Morso liscio
Mandíbula lisa
Mors lisse

Feingeriefes Maul
Fine serrated jaws
Morso zigrinato fine
Mandíbula estriada fina
Mors strié fin

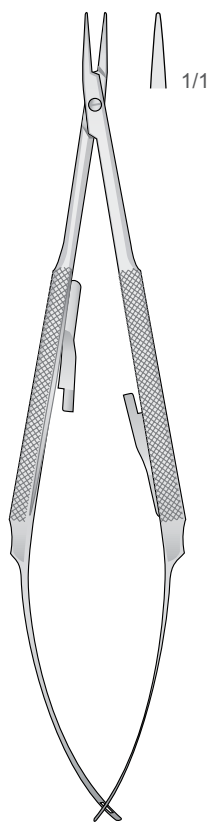

**BARRAQUER
FD-216**
150 mm

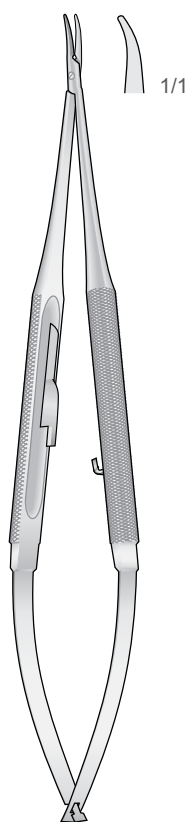

**BARRAQUER
FD-217**
150 mm

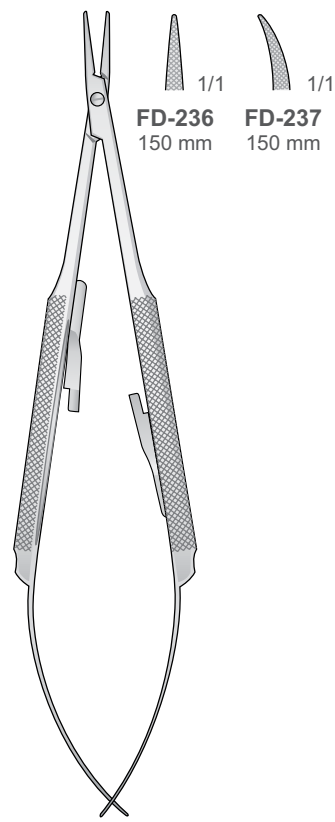

**BARRAQUER
FD-236/FD-237**
150 mm

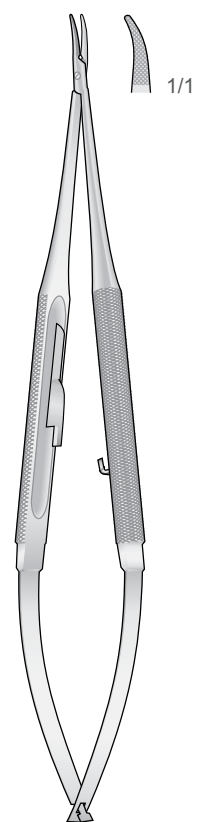

**BARRAQUER
FD-24**
150 mm

Needle Holders

Nadelhalter
Port'aghi
Portaagujas
Porte aiguilles

Drivers

Treiber
Conductrices
Autiste
Drayvery



Tungsten-Carbide Inserts
Mit Hartmetalleinsätzen
Plaquettes en carbure de tungstène
Plaquetas de carburo de tungsteno
Inserti in carburo di tungsteno

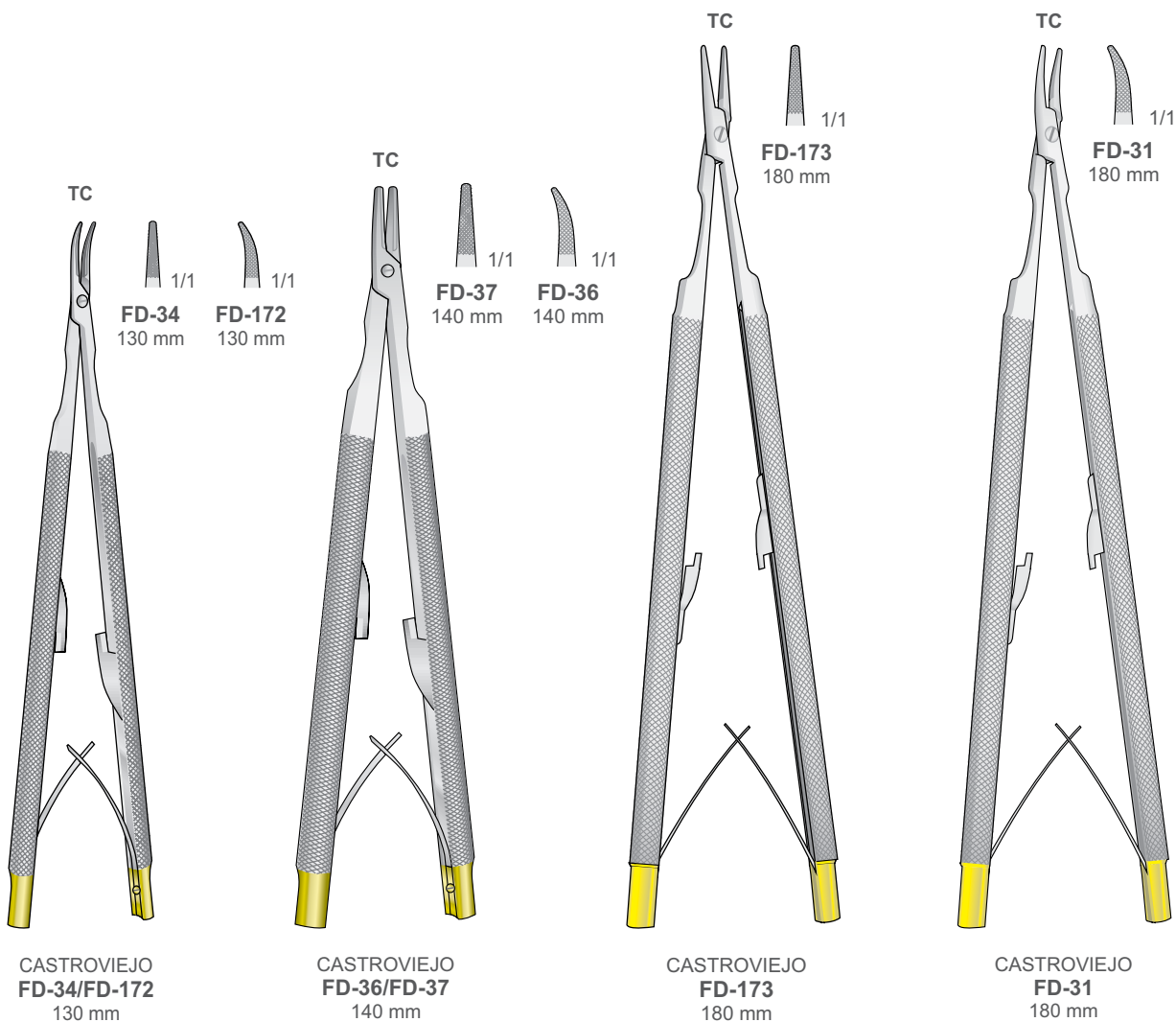

Needle Holders

Nadelhalter
Port'aghi
Portaagujas
Porte aiguilles



Tungsten-Carbide Inserts
Mit Hartmetalleinsätzen
Plaquettes en carbure de tungstène
Plaquetas de carburo de tungsteno
Inserti in carburo di tungsteno

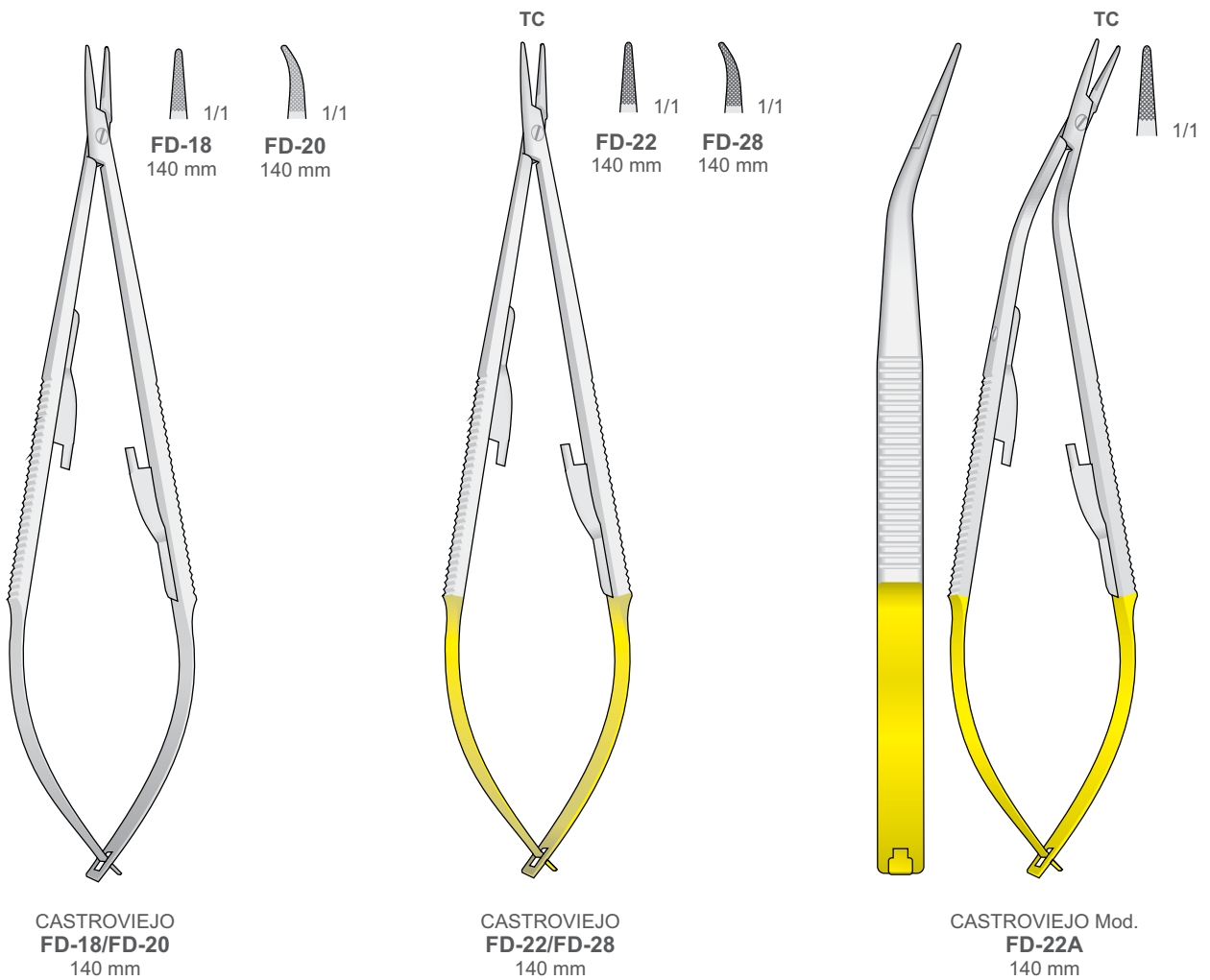

Needle Holders

Nadelhalter
Port'aghi
Portaagujas
Porte aiguilles

Drivers

Treiber
Conductrices
Autiste
Drayvery



Tungsten-Carbide Inserts
Mit Hartmetalleinsätzen
Plaquettes en carbure de tungstène
Plaquetas de carburo de tungsteno
Inserti in carburo di tungsteno

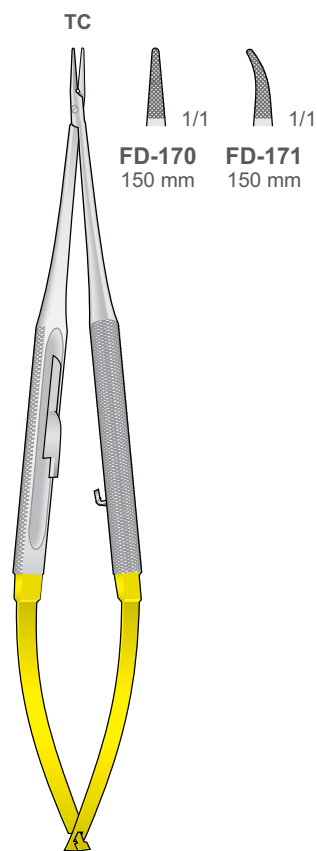

JACOBSON
FD-170/FD-171
150 mm

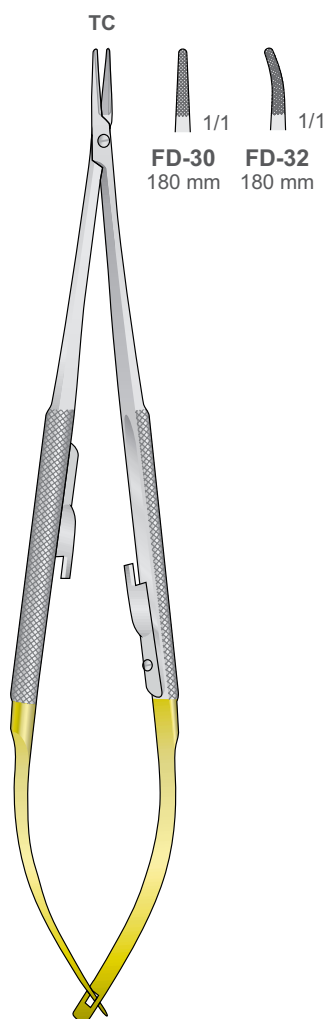

JACOBSON
FD-30/FD-32
180 mm

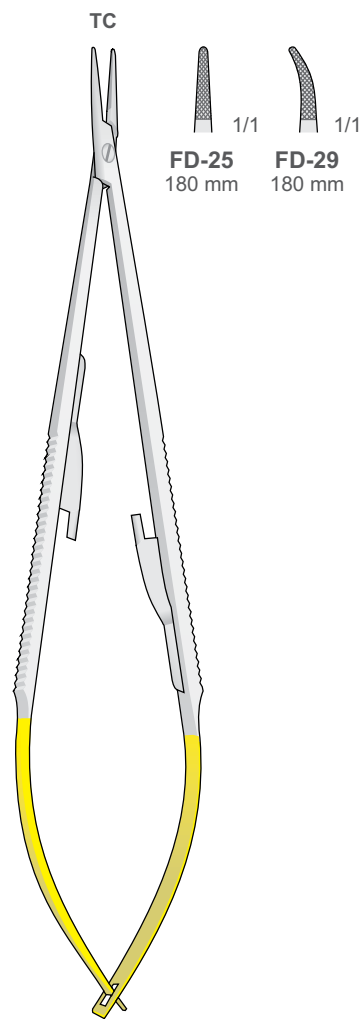

CASTROVIEJO
FD-25/FD-29
180 mm

Needle Holders

Nadelhalter
Port'aghi
Portaagujas
Porte aiguilles



Tungsten-Carbide Inserts
Mit Hartmetalleinsätzen
Plaquettes en carbure de tungstène
Plaquetas de carburo de tungsteno
Inserti in carburo di tungsteno

Glattes Maul
Smooth jaws
Con morso liscio
Mandibula lisa
A' mors lisse

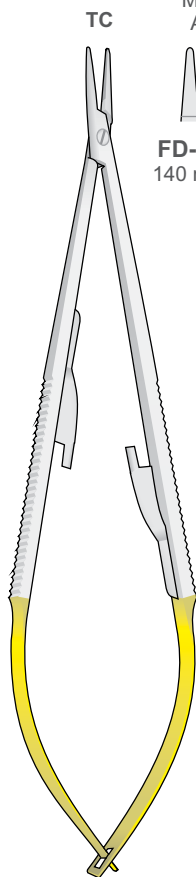

CASTROVIEJO
FD-21/FD-23
140 mm

TC
1/1
1/1
FD-21
140 mm
FD-23
140 mm

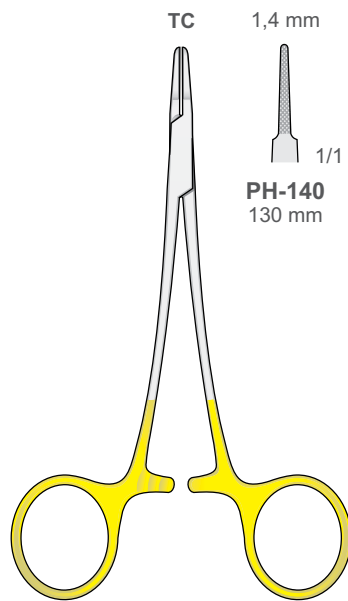

MICRO-RYDER
PH-140/PH-142

TC
1,4 mm
1,4 mm
1,4 mm
1/1
1/1
1/1
PH-140
130 mm
PH-141
150 mm
PH-142
180 mm

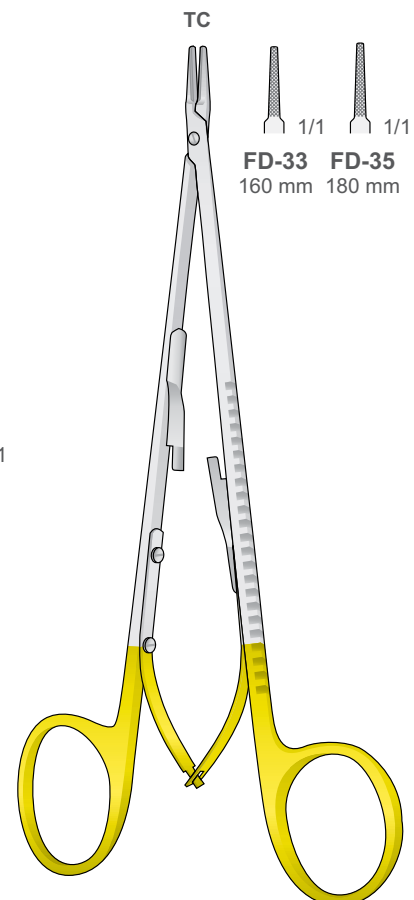

DIETRICH
FD-33/FD-35

TC
1/1
1/1
FD-33
160 mm
FD-35
180 mm

Micro Needle Holders - Micro Scissors

Mikro Nadelhalter - Mikro Scheren
 Micro Port'aghi - Micro Forbici
 Micro Portaagujas - Micro Tijeras
 Micro Porte aiguilles - Micro Ciseaux

Drivers

Treiber
 Conduccrives
 Autiste
 Drayvery



Rund-Griffe Ø 8 mm
 Round handle Ø 8 mm
 Manico rotondo Ø 8 mm
 Mango redondo Ø 8 mm
 Manche rond Ø 8 mm

Mikro Nadelhalter
 Micro Needle Holders
 Micro port'aghi
 Micro portaagujas
 Micro porte aiguilles

Mikro Scheren
 Micro Scissors
 Micro forbici
 Micro tijeras
 Micro ciseaux

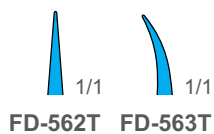
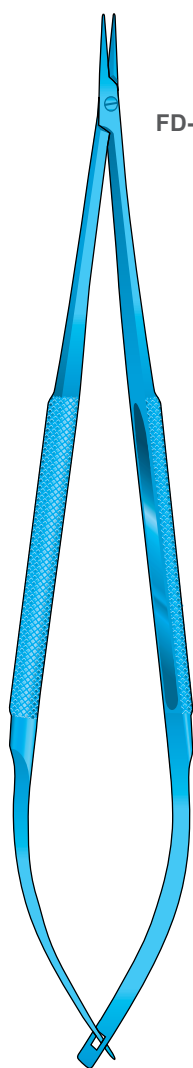

FD-562T/FD-563T
 180 mm

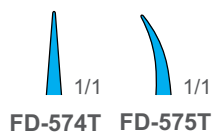
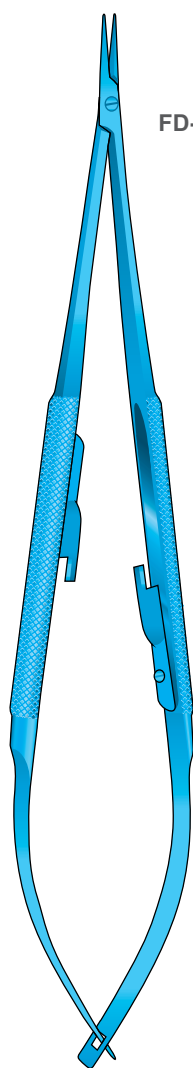

Mit Sperre
 With Lock
 Con arresto
 Con cierre
 Avec Arrêt

FD-574T/FD-575T
 180 mm

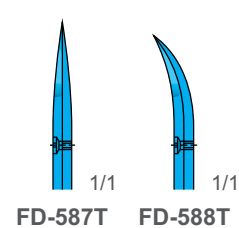
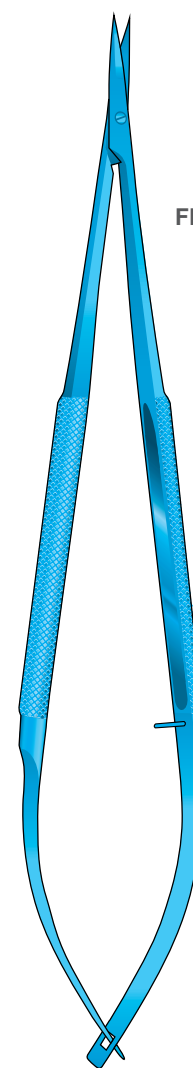

FD-587T/FD-588T
 180 mm

Needle Holders

Nadelhalter
Port'aghi
Portaagujas
Porte aiguilles

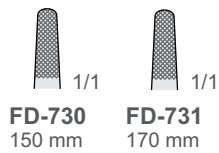
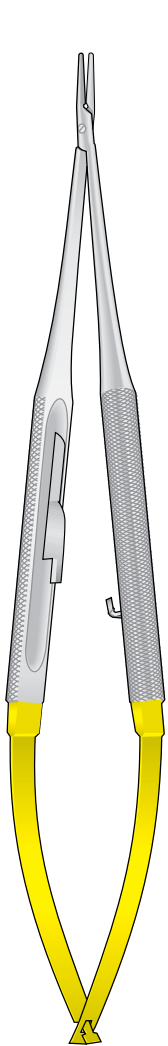

CASTROVIEJO
Fine
Straight
Locking
Thick Jaw
Round Handle

CASTROVIEJO
FD-730 / FD-731
150 / 170 mm

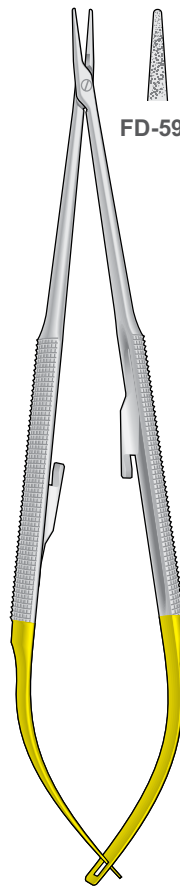

FD-599/FD-600
150 mm

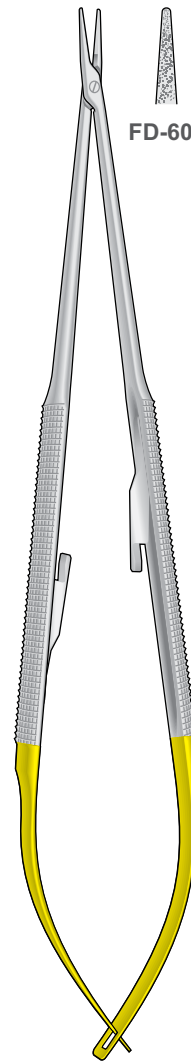

FD-601/FD-602
180 mm

Needle Holders

Nadelhalter
Port'aghi
Portaagujas
Porte aiguilles

Drivers

Treiber
Conductrices
Autiste
Drayvery

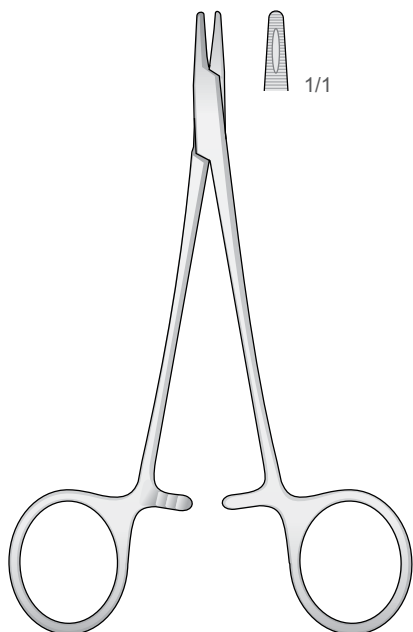

DERF
PH-39
125 mm

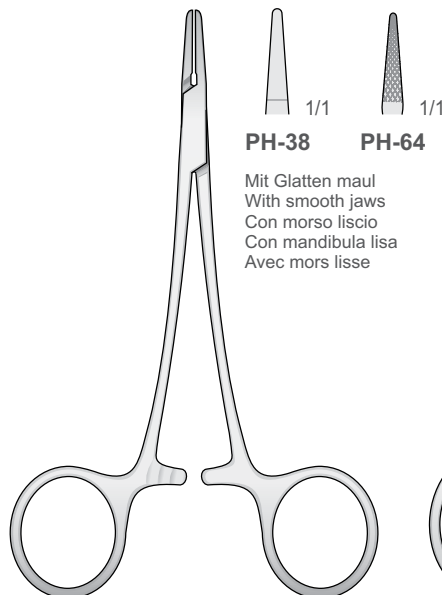

PH-38 PH-64

Mit Glatten maul
With smooth jaws
Con morso liscio
Con mandibula lisa
Avec mors lisse

PH-38/PH-64
120 mm

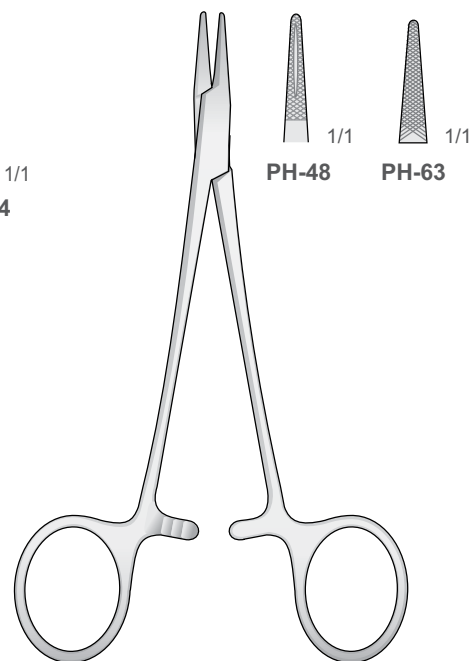

PH-48 PH-63

HALSEY
PH-48/PH-63
130 mm

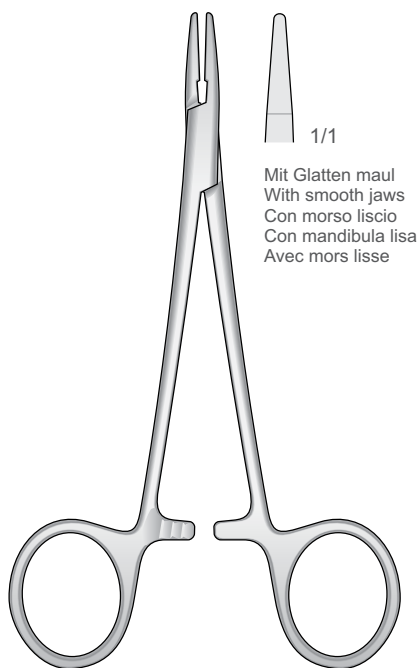

Mit Glatten maul
With smooth jaws
Con morso liscio
Con mandibula lisa
Avec mors lisse

HALSEY
PH-37
130 mm

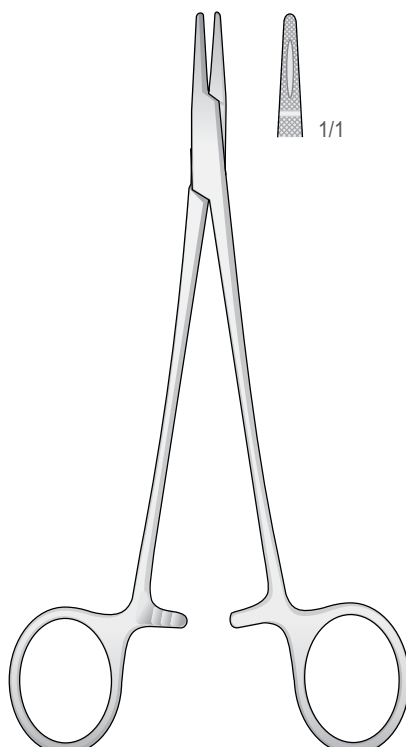

CRILE-WOOD
PH-61
150 mm

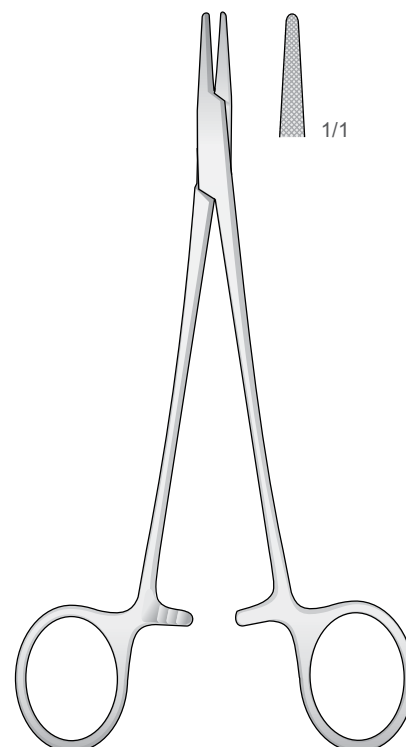

CRILE-MURRAY
PH-62
150 mm

Needle Holders

Nadelhalter
Port'aghi
Portaagujas
Porte aiguilles

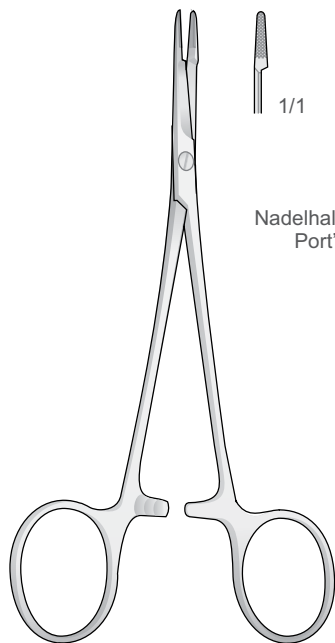

MINI-OLSEN-HEGAR
BM-61
120 mm

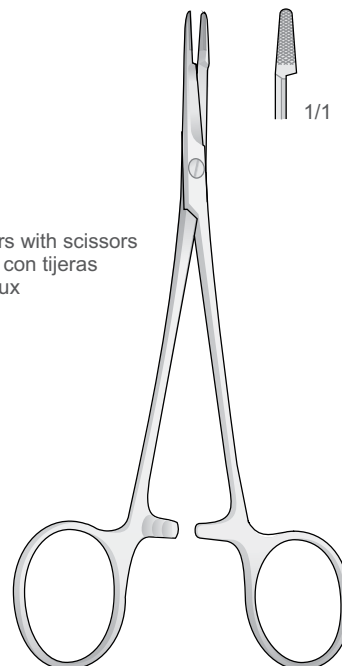

OLSEN-HEGAR
BM-62
140 mm

Nadelhalter mit Schere - Needle holders with scissors
Port'aghi con forbici - Portaagujas con tijeras
Porte aiguilles avec ciseaux

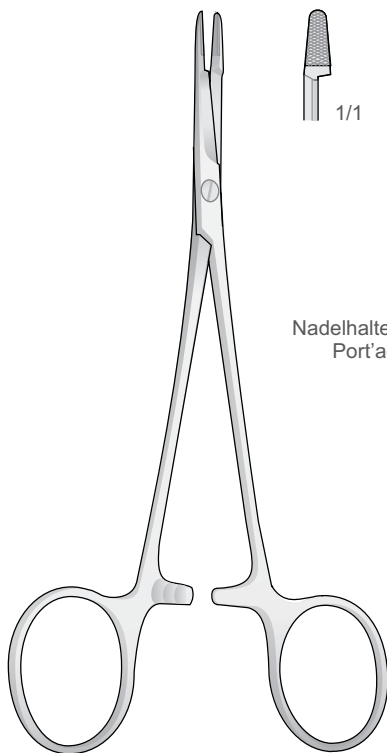

OLSEN-HEGAR
BM-63
170 mm

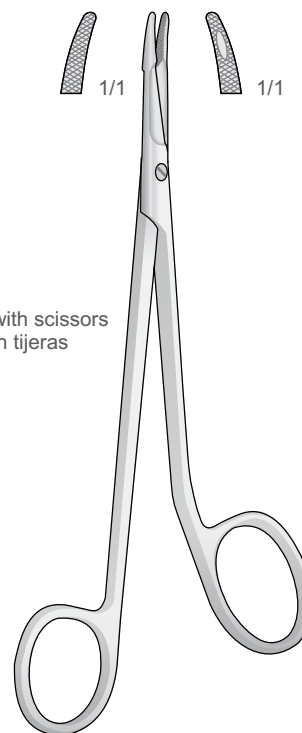

MINI-GILLIES
PO-59
145 mm

Nadelhalter mit Schere - Needle holders with scissors
Port'aghi con forbici - Portaagujas con tijeras
Porte aiguilles avec ciseaux

Needle Holders

Nadelhalter
Port'aghi
Portaagujas
Porte aiguilles

Drivers

Treiber
Conductrices
Autiste
Drayvery

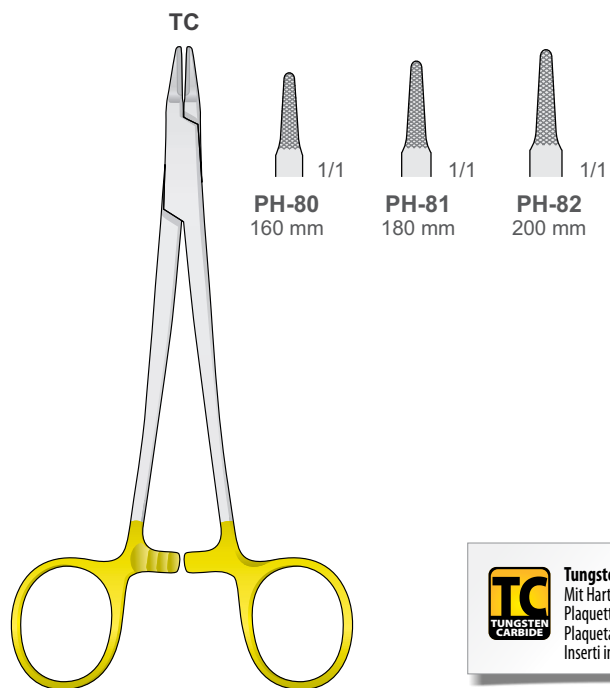

RYDER
PH-80/PH-82

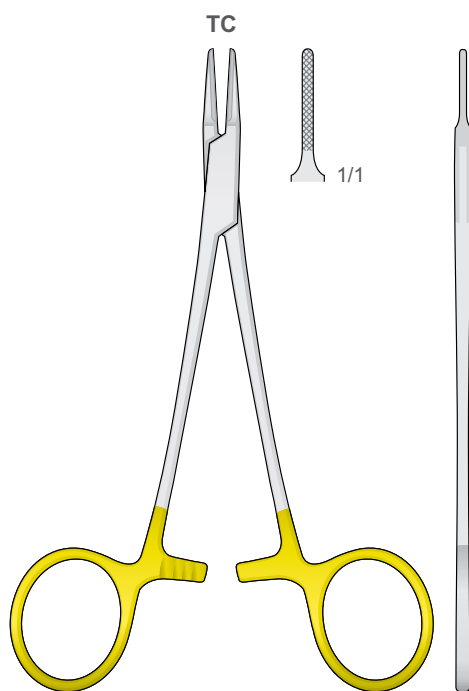

RYDER
PH-83
140 mm

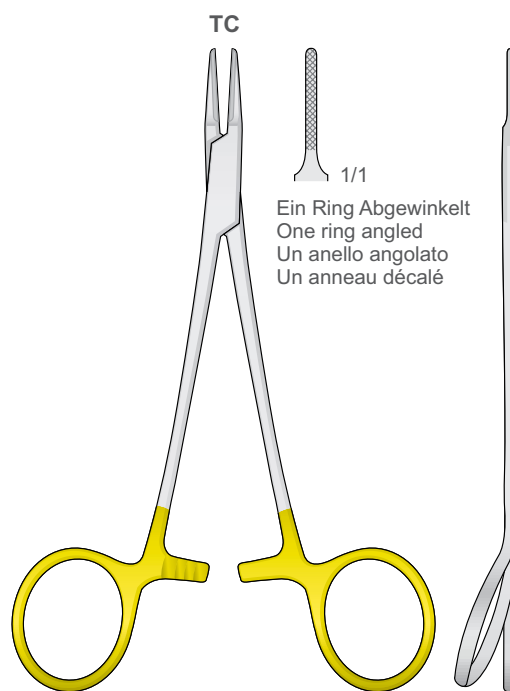

PH-84
140 mm

Needle Holders

Nadelhalter
Port'aghi
Portaagujas
Porte aiguilles

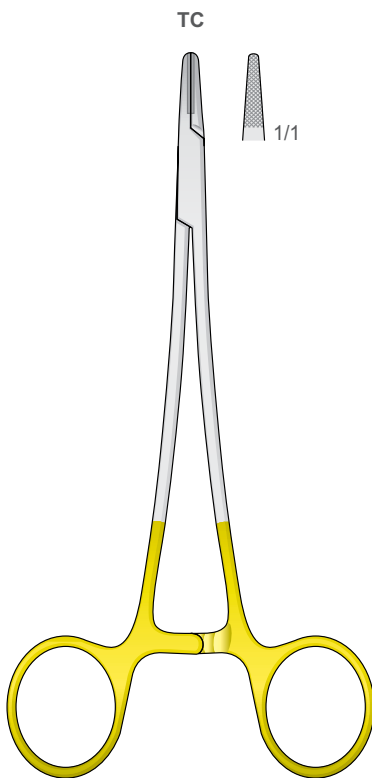

CRILE-WOOD
PH-79
145 mm

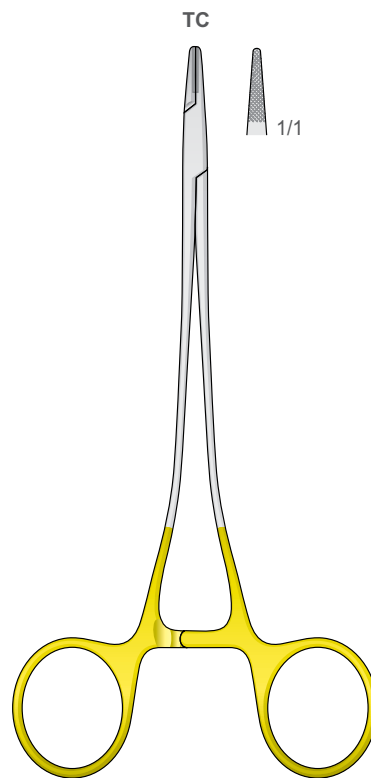

FINE SWEDISH PATTERN
PH-85
150 mm

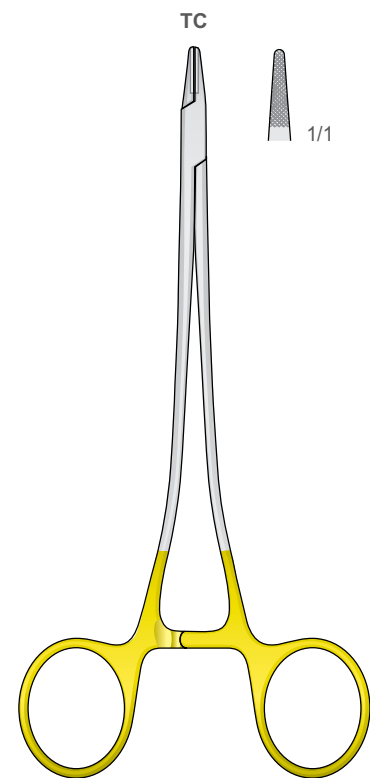

SWEDISH MOD.
PH-106
150 mm

Needle Holders

Nadelhalter
Port'aghi
Portaagujas
Porte aiguilles

Drivers

Treiber
Conductrices
Autiste
Drayvery

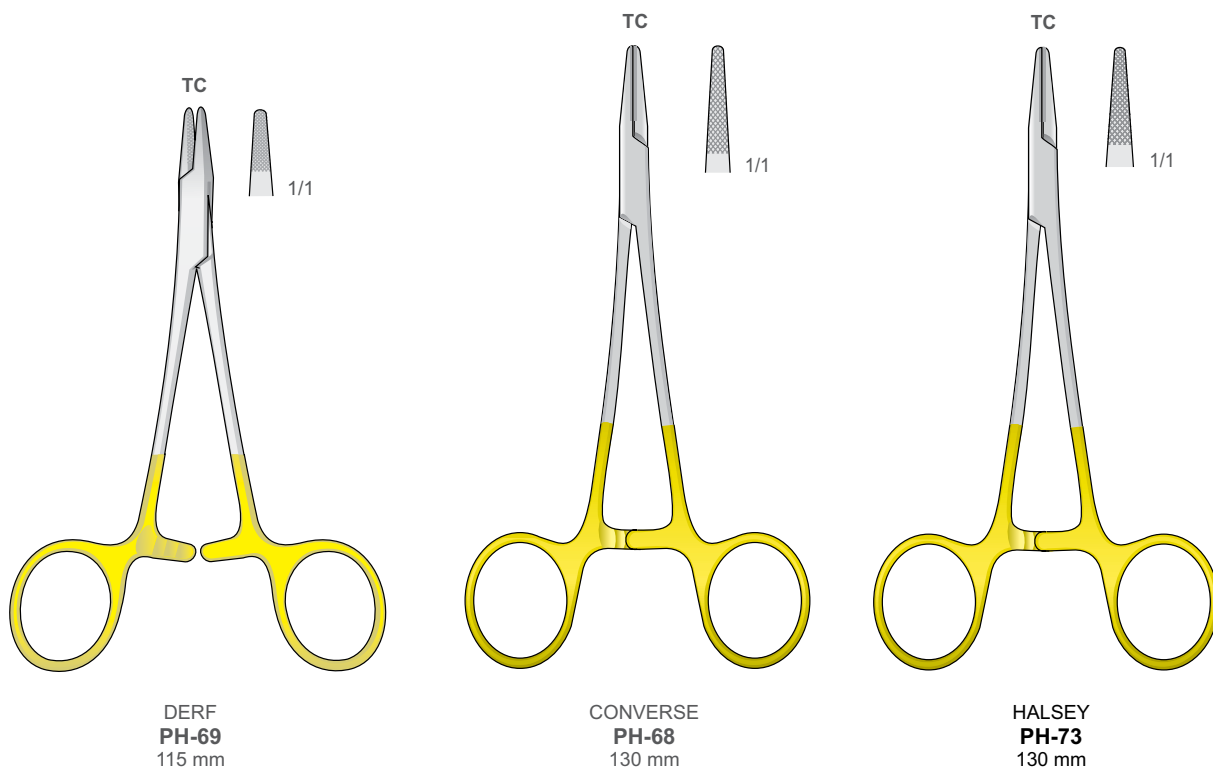
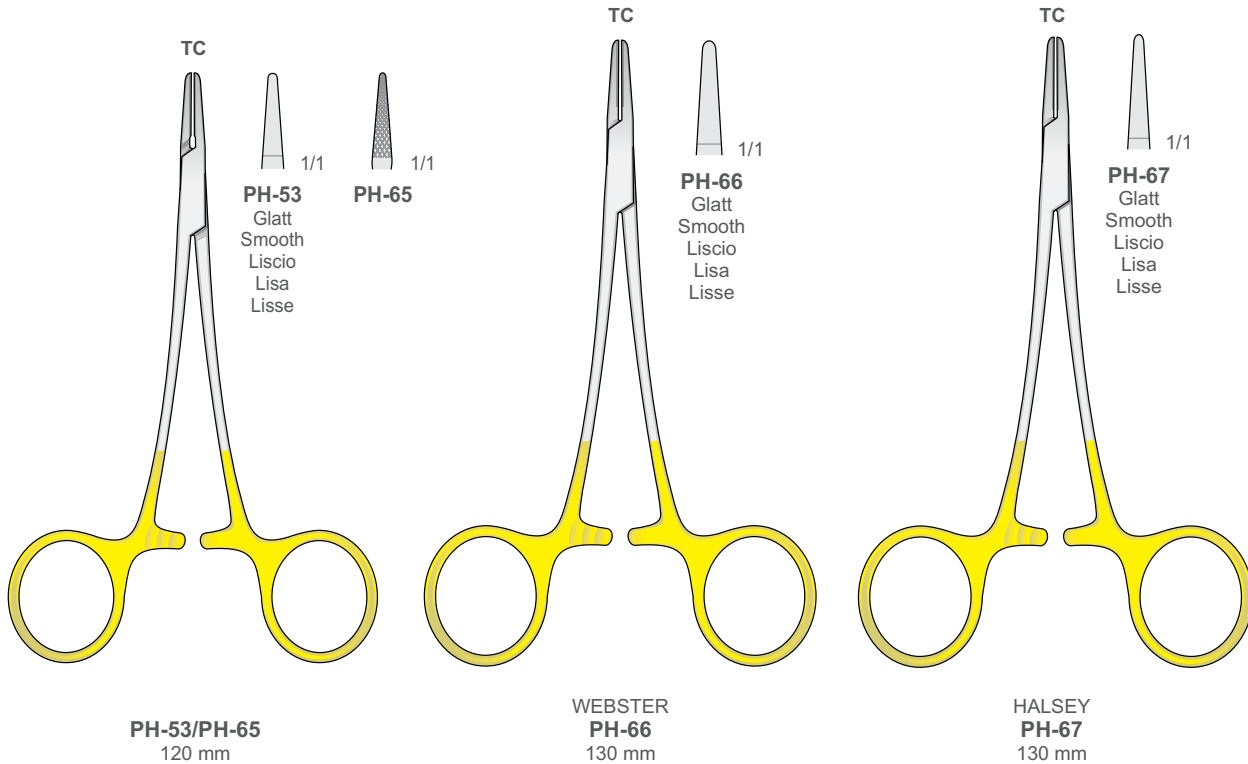

Needle Holders

Nadelhalter
Port'aghi
Portaagujas
Porte aiguilles



Tungsten-Carbide Inserts
Mit Hartmetalleinsätzen
Plaquettes en carbure de tungstène
Plaquetas de carburo de tungsteno
Inserti in carburo di tungsteno

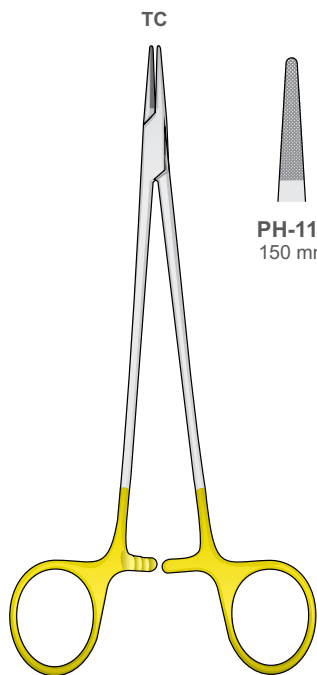

DE BAKEY
PH-110/PH-111

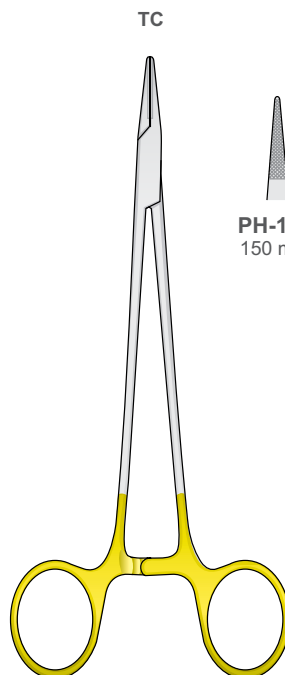
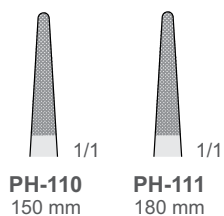

MICRO-VASCULAR
PH-101/PH-102/PH-103

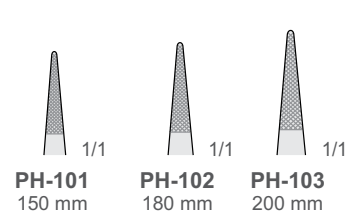

Vascular
Vaskuläre
Vasculaire
Vasculares
Vascolari

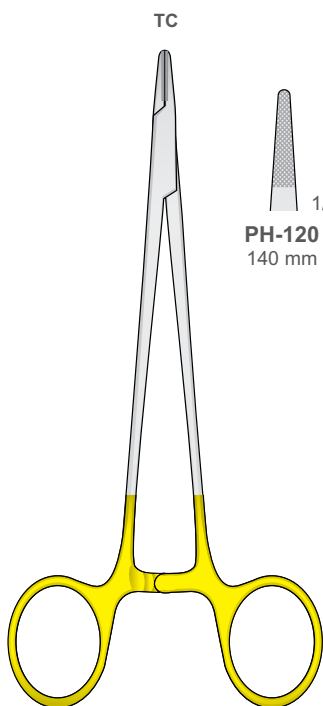

HEGAR
PH-120/PH-121/PH-122

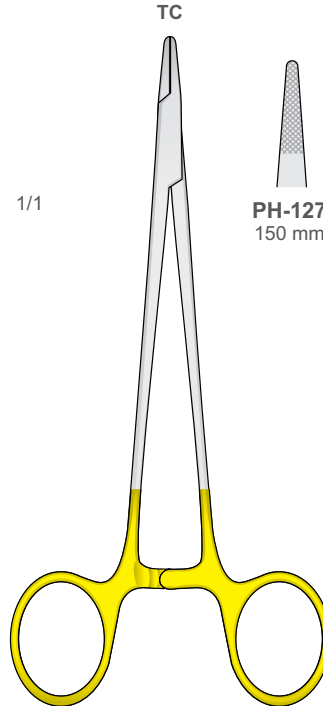
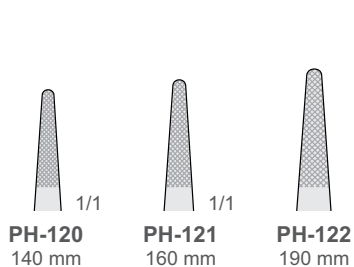

MAYO-HEGAR-FINO
PH-127/PH-128/PH-129

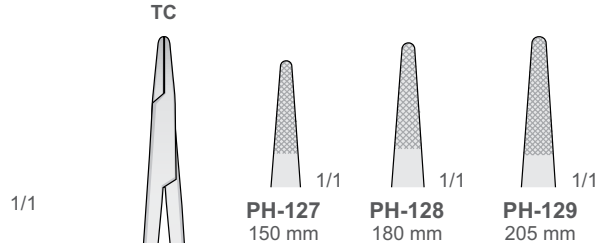

Needle Holders

Nadelhalter
Port'aghi
Portaagujas
Porte aiguilles

Drivers

Treiber
Conductrices
Autiste
Drayvery

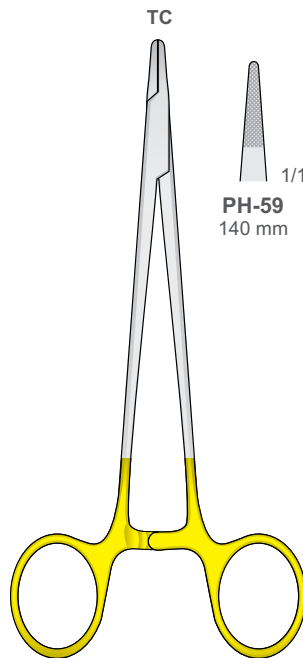

HEGAR
PH-59/PH-72/PH-75/PH-76

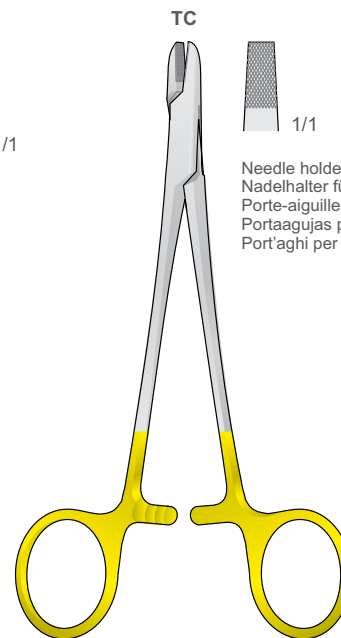
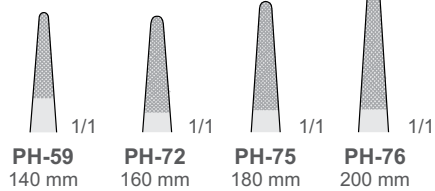

PH-58
150 mm

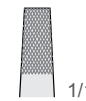

Needle holders for wire
Nadelhalter für drähte
Porte-aiguilles pour fil métallique
Portaagujas para hilo metálico
Port'aghi per fili metallici

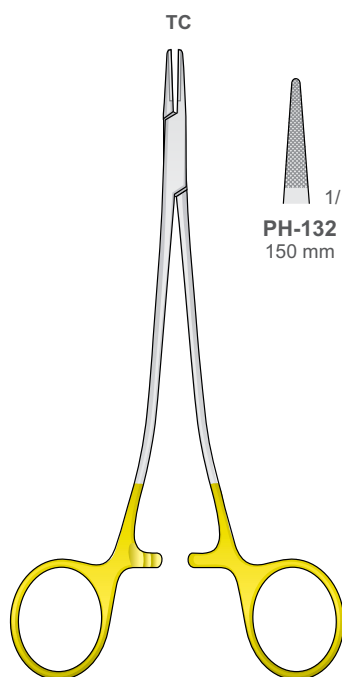

SAROT
PH-132/PH-133/PH-134

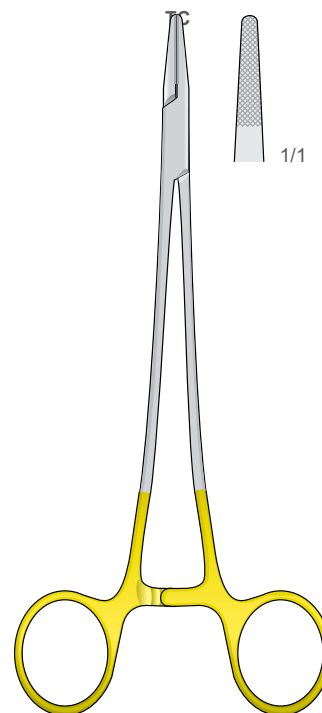
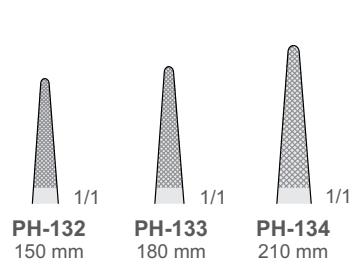

CRILE-WOOD
PH-77
180 mm

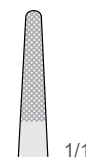

Needle Holders

Nadelhalter
Port'aghi
Portaagujas
Porte aiguilles



Tungsten-Carbide Inserts
Mit Hartmetalleinsätzen
Plaquettes en carbure de tungstène
Plaquetas de carburo de tungsteno
Inserti in carburo di tungsteno

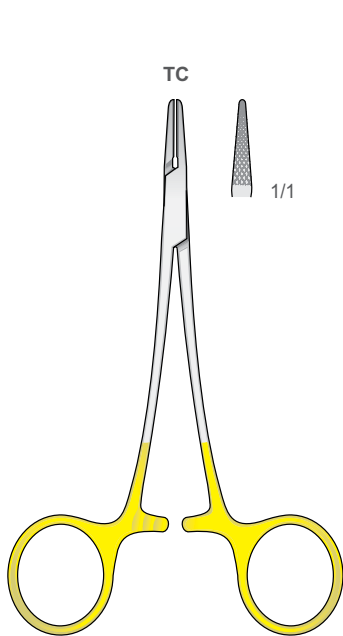

PH-99
120 mm

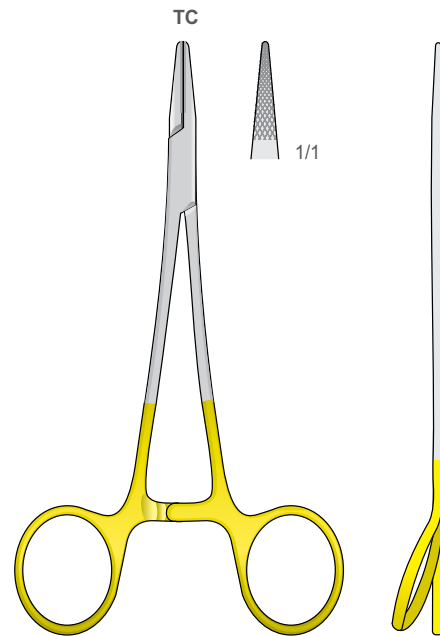

CRILE-WOOD PH-100
150 mm

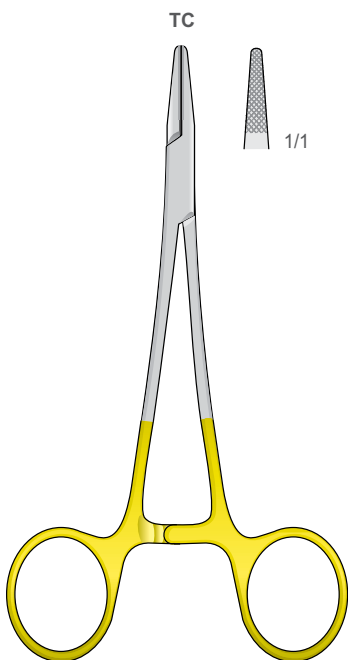

BABY-CRILE-WOOD PH-54
150 mm

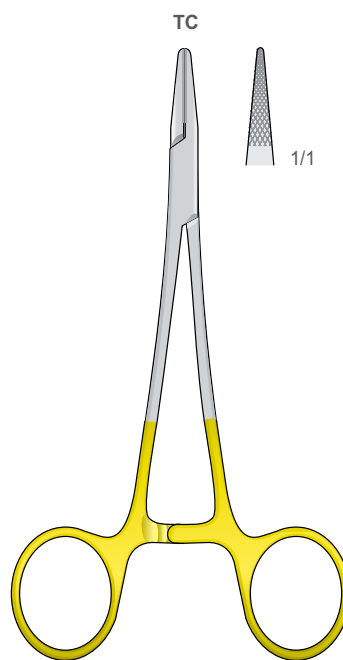

CRILE-WOOD PH-71
150 mm

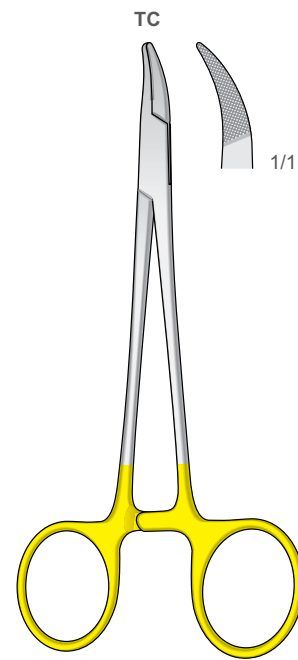

CRILE-WOOD PH-90
150 mm

Needle Holders

Nadelhalter
Port'aghi
Portaagujas
Porte aiguilles

Drivers

Treiber
Conductrices
Autiste
Drayvery



Tungsten-Carbide Inserts
Mit Hartmetalleinsätzen
Plaquettes en carbure de tungstène
Plaquetas de carburo de tungsteno
Inserti in carburo di tungsteno

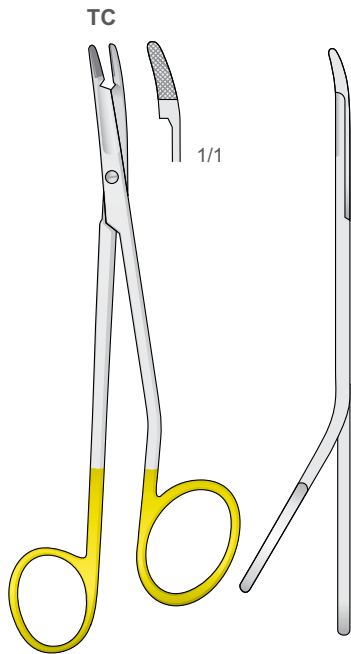

**MINI-GILLIES
PO-99**
145 mm

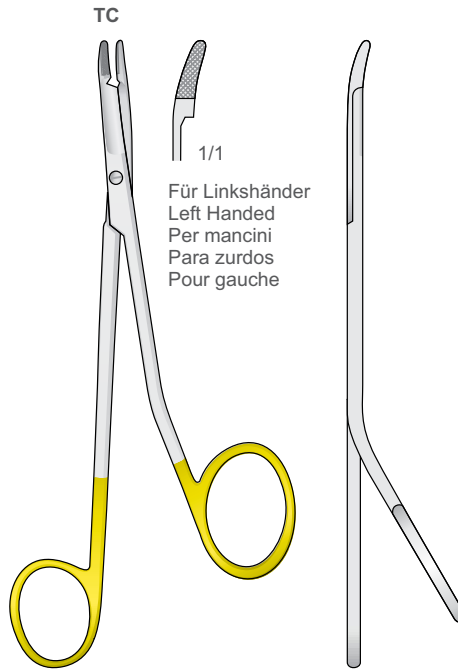

**MINI-GILLIES
PO-99L**
145 mm

Für Linkshänder
Left Handed
Per mancini
Para zurdos
Pour gauche

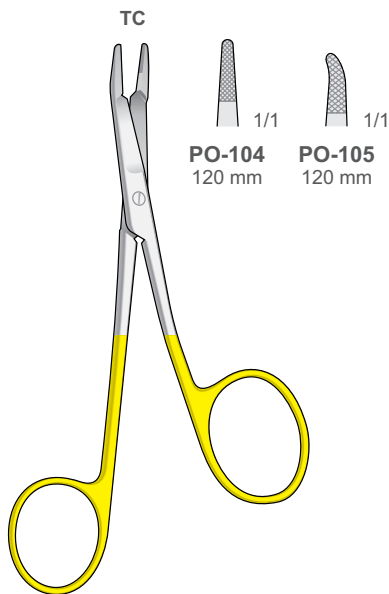

**FOSTER-GILLIES
PO-104/PO-105**
120 mm

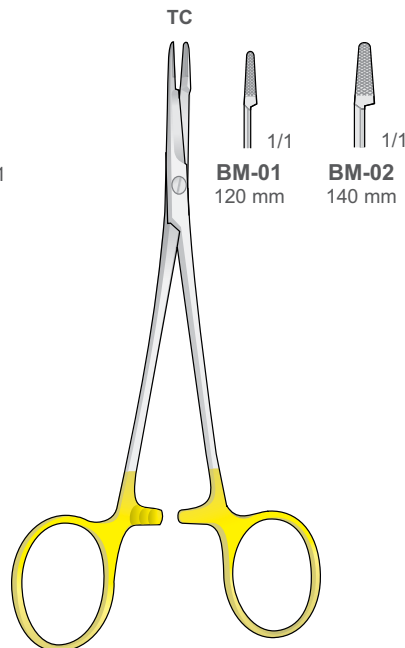

**OLSEN-HEGAR
BM-01/BM-02**

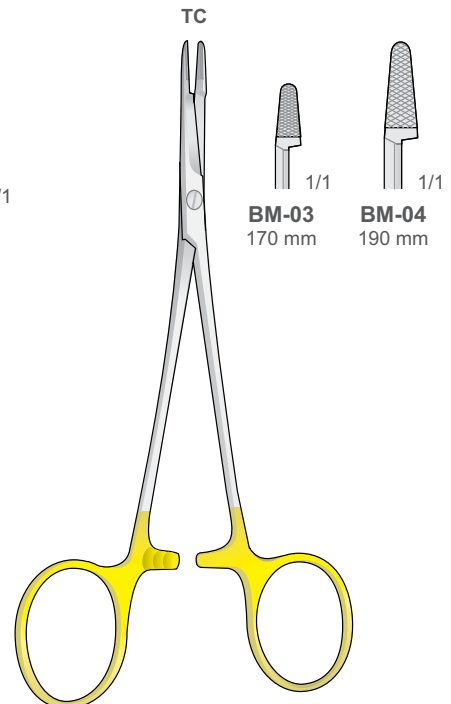

**OLSEN-HEGAR
BM-03/BM-04**

Needle Holders

Nadelhalter
Port'aghi
Portaagujas
Porte aiguilles

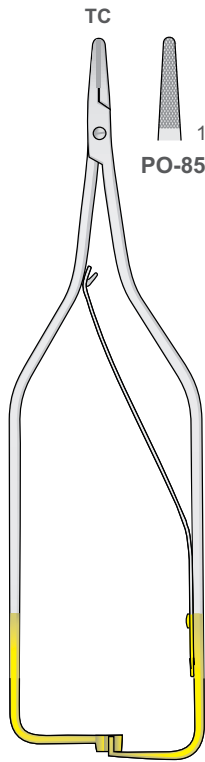

ARRUGA
PO-85/PO-87
160 mm

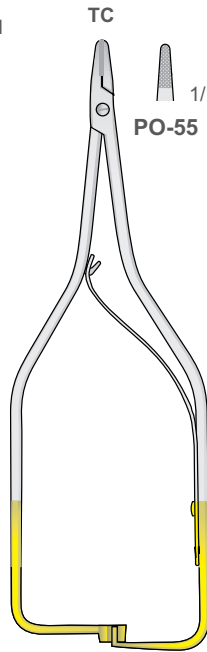

BOYNTON
PO-55/PO-56
120 mm

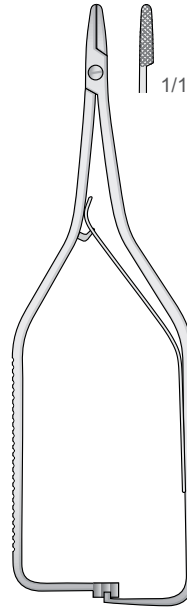

BOYNTON
PO-88
120 mm

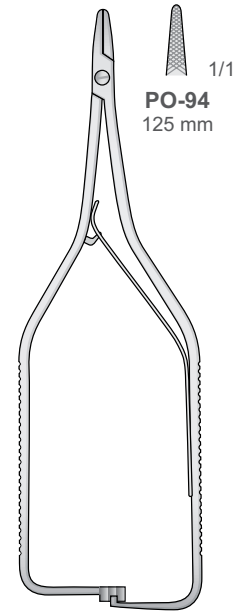

BOYNTON
PO-94
125 mm

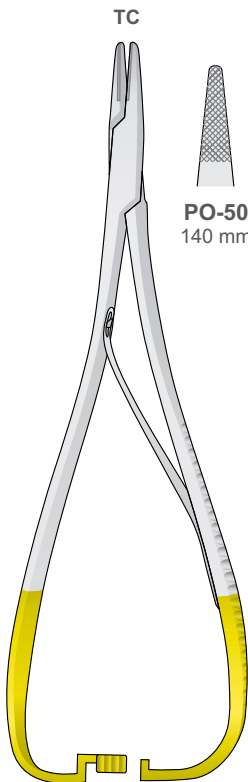

MATHIEU
PO-50/PO-52

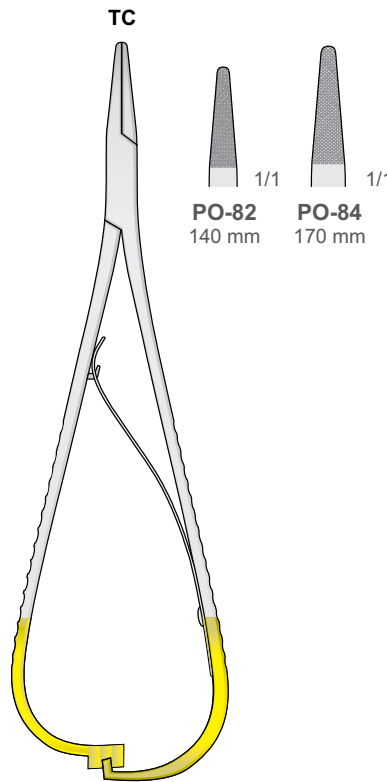

MATHIEU
PO-82/PO-84

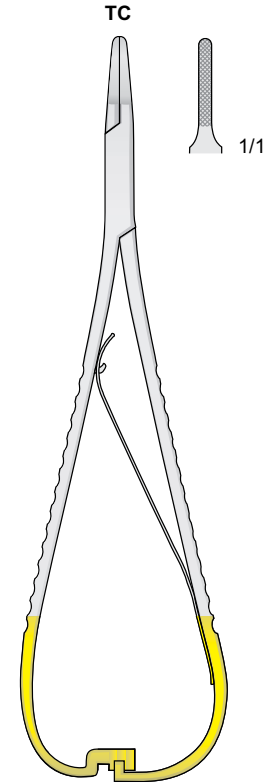

LICHTENBERG
PO-86
175 mm

Needle Holders

Nadelhalter
Port'aghi
Portaagujas
Porte aiguilles

Drivers

Treiber
Conductrices
Autiste
Drayvery

Needle Holders
Port'aghi
Portaagujas
Porte aiguilles

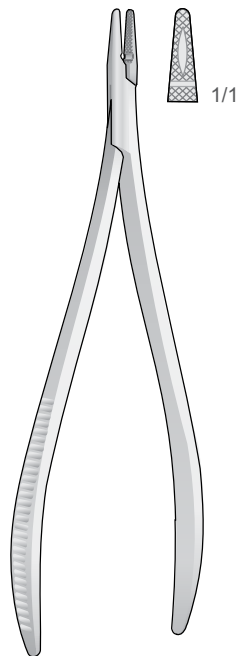

CRILE
PO-37
150 mm

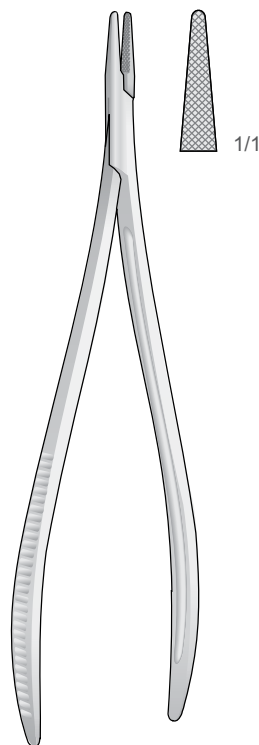

TÖNNIS
PO-38
190 mm

Schlankesmodell - Delicate pattern - Modello fine
Modelo delegado - Modèle fin

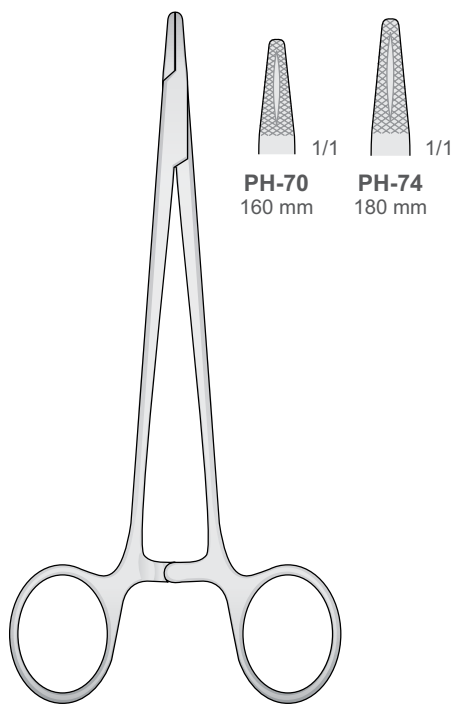

MAYO-HEGAR
PH-70/PH-74

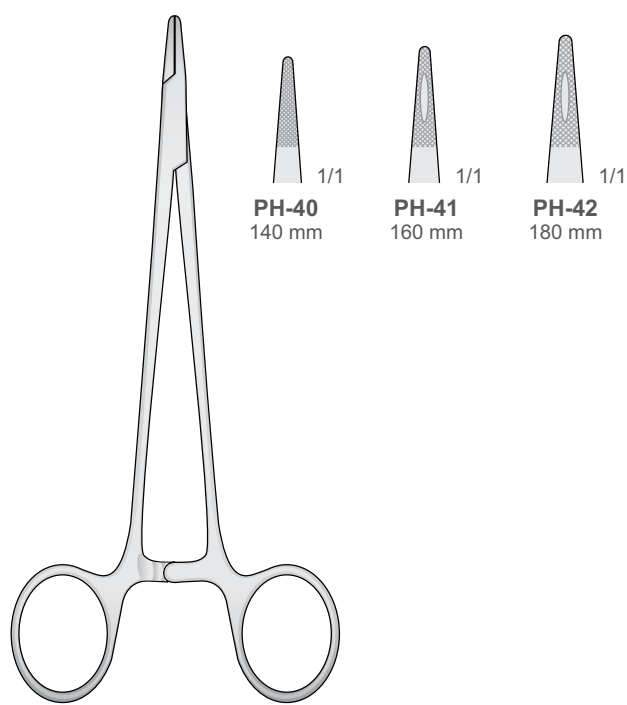

MAYO-HEGAR
PH-40/PH-42

Needle Holders

Nadelhalter
Port'aghi
Portaagujas
Porte aiguilles

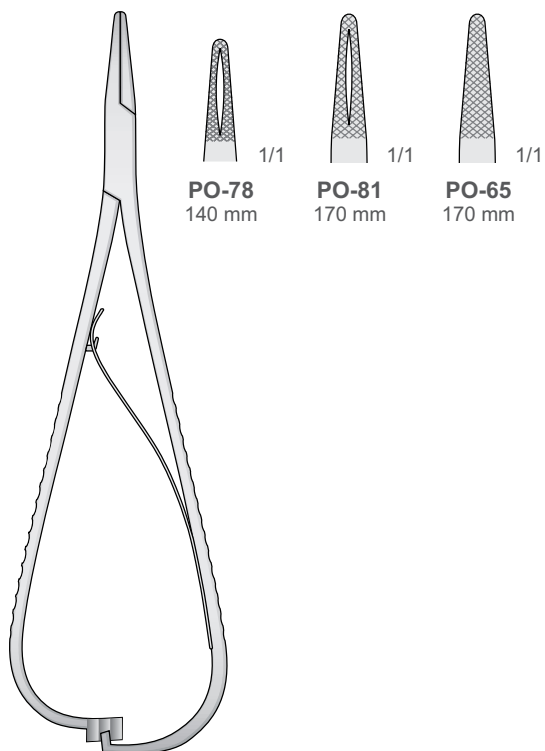

MATHIEU
PO-65/PO-81

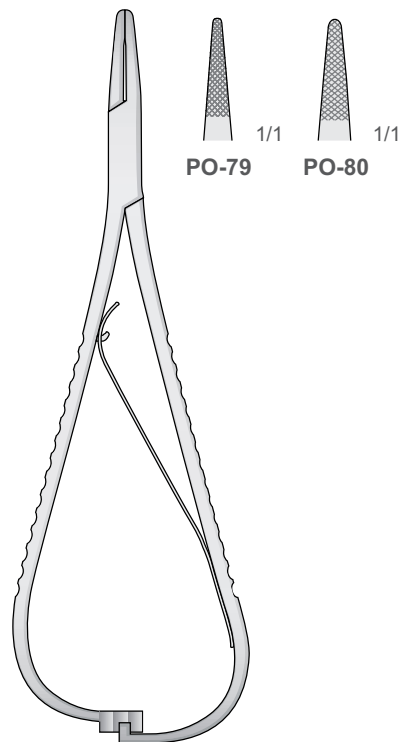

MATHIEU
PO-79/PO-80
140 mm

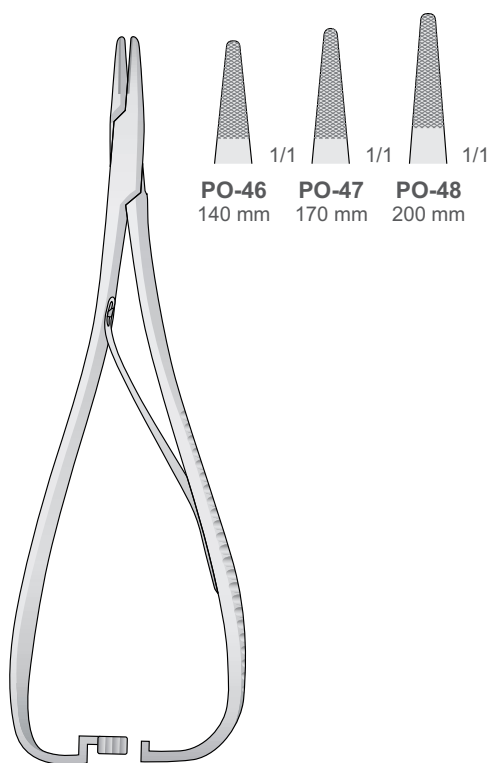

MATHIEU
PO-46/PO-48

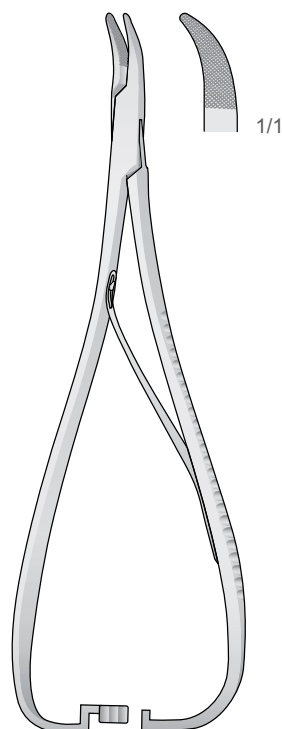

PO-40
140 mm

Needle Holders

Nadelhalter
Port'aghi
Portaagujas
Porte aiguilles

Drivers

Treiber
Conductrices
Autiste
Drayvery

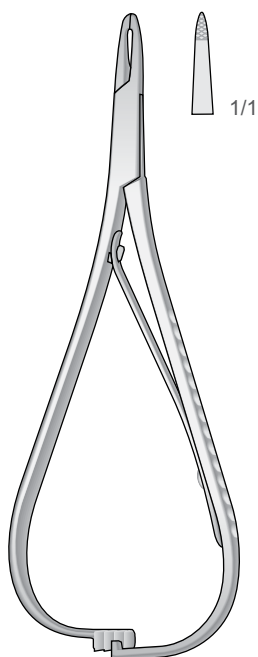

MATHIEU
PO-45
125 mm

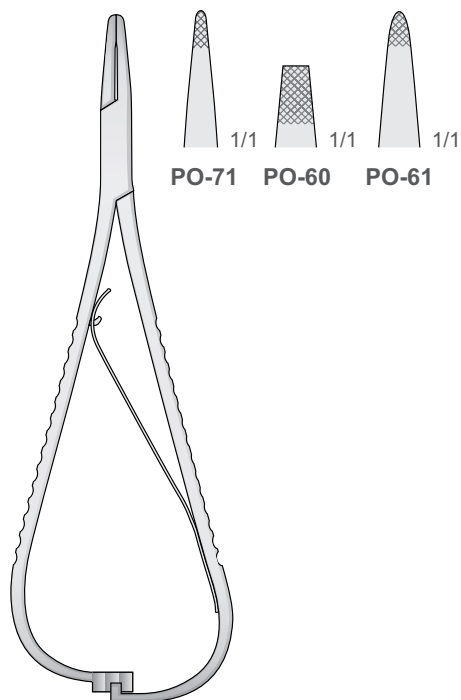

MATHIEU
PO-60/PO-71
140 mm

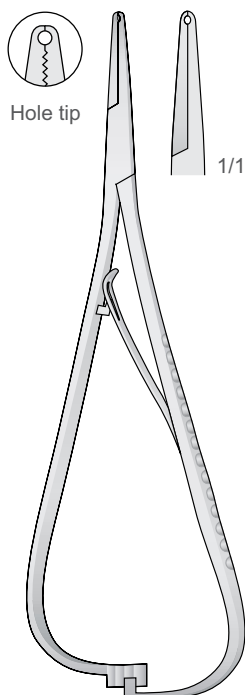

SMAHA
PO-68
140 mm

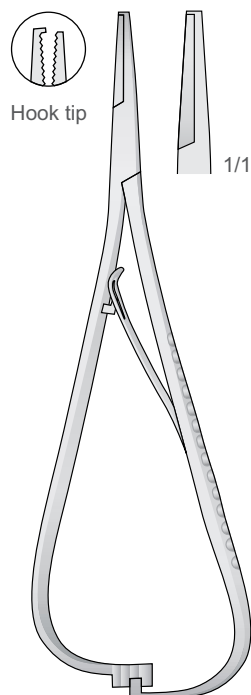

SMAHA
PO-69
140 mm

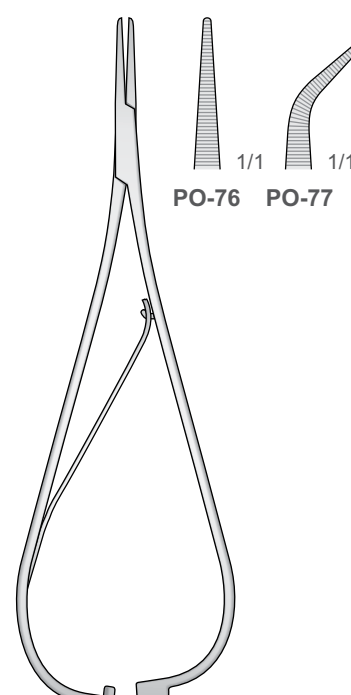

SMAHA
PO-76/PO-77
140 mm

MSD

GRASPING FORCEPS



Towel Clamps

Tuchklemmen
Fissateli
Pinzas de campo
Pincés fixe-compresses

Hemostats /Grasping Forceps

Hämostatika / Greifen
Hémostats / Saisir
Emostatici / Presa
Krovoostanavlivayushchiye

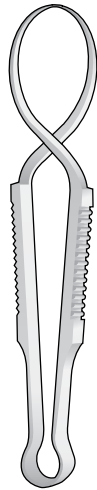

SCHAEFFEL
BF-38
85 mm

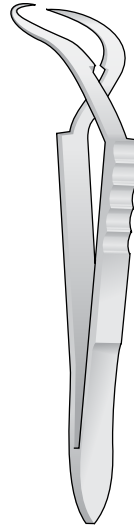

JONES
BF-48
90 mm

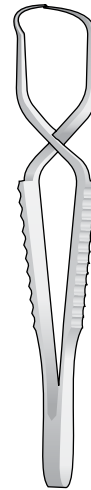

FAURE
BF-40
85 mm

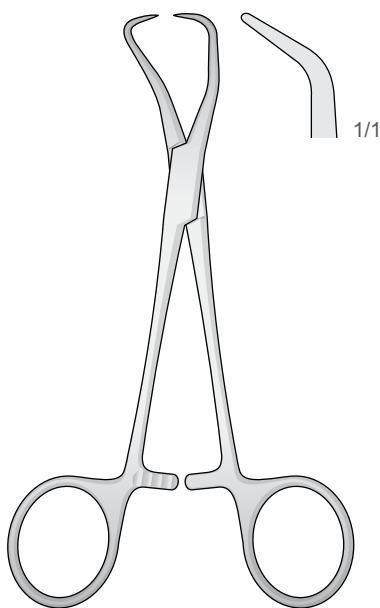

BACKHAUS
BF-42/BF-46



BF-42
90 mm



BF-41
100 mm



BF-44
110 mm

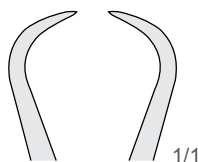

BF-46
130 mm

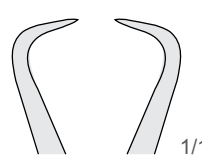

BF-43
135 mm

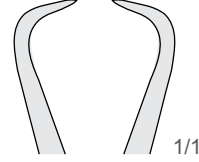

BF-45
140 mm

Towel Clamps

Tuchklemmen

Fissateli

Pinzas de campo

Pinces fixe-compresses

Für Papiertücher
For paper cloths
Per teli di carta
Para paños
Pour papier

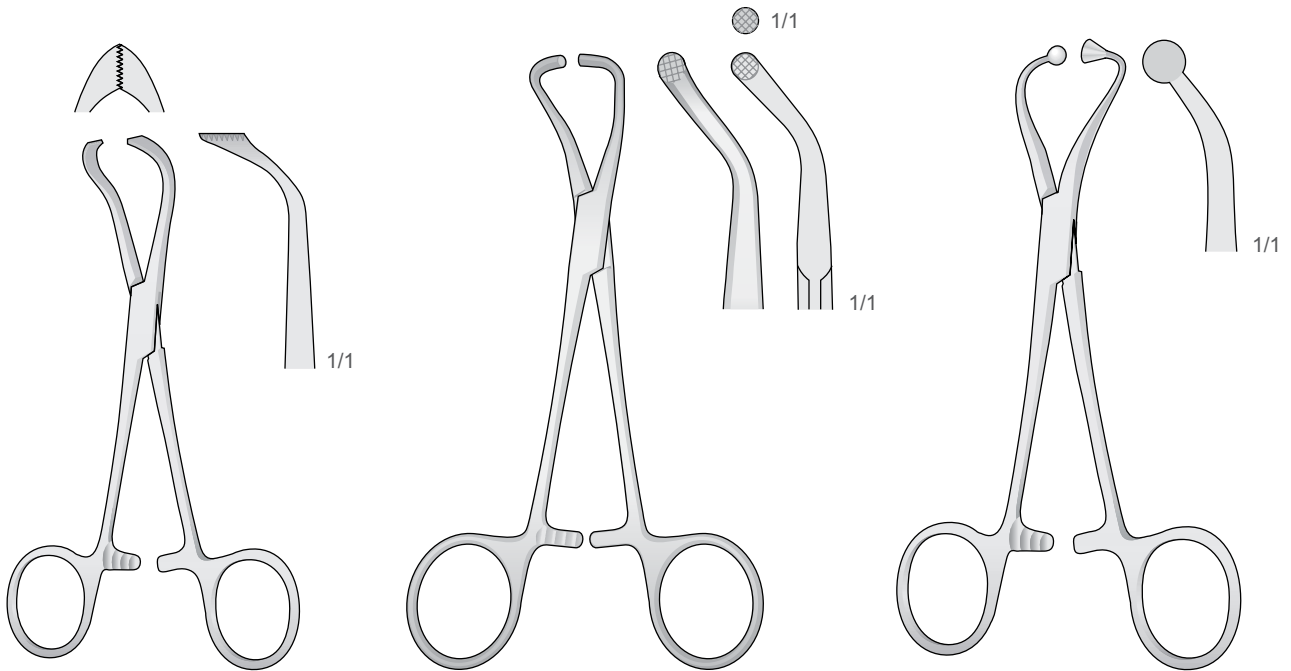

LORNA
BF-50
100 mm

BF-52
130 mm

BF-75
140 mm

Sponge and Dressing Forceps

Schwamm und Tamponzangen
Pinze per tamponi e spunge
Pinzas para esponja y tampones
Pincas pour éponges et à pansement

Hemostats /Grasping Forceps

Hämostatika / Greifen
Hémostats / Saisir
Emostatici / Presa
Krovoostanavlivayushchiye

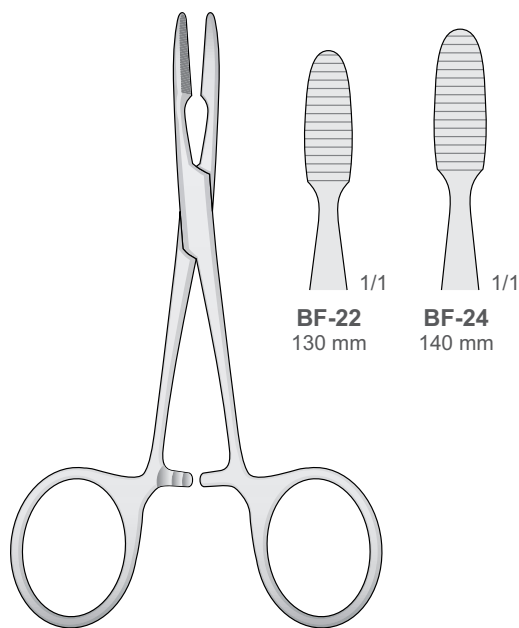

PEAN-MURPHY
BF-22/BF-24

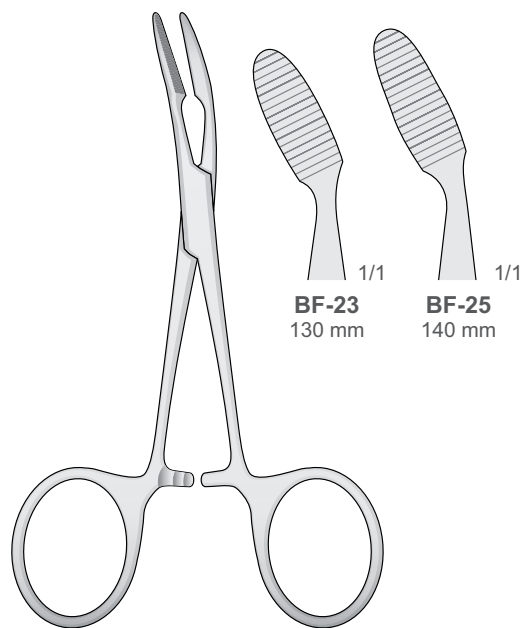

PEAN-MURPHY
BF-23/BF-25

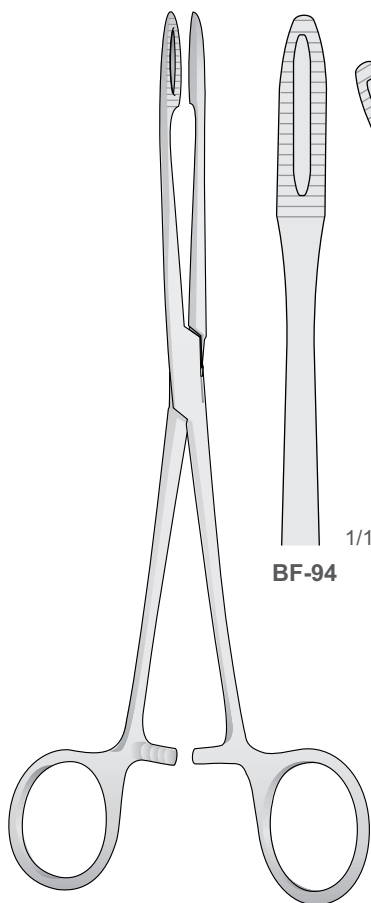

GROSS
BF-94/BF-95
200 mm

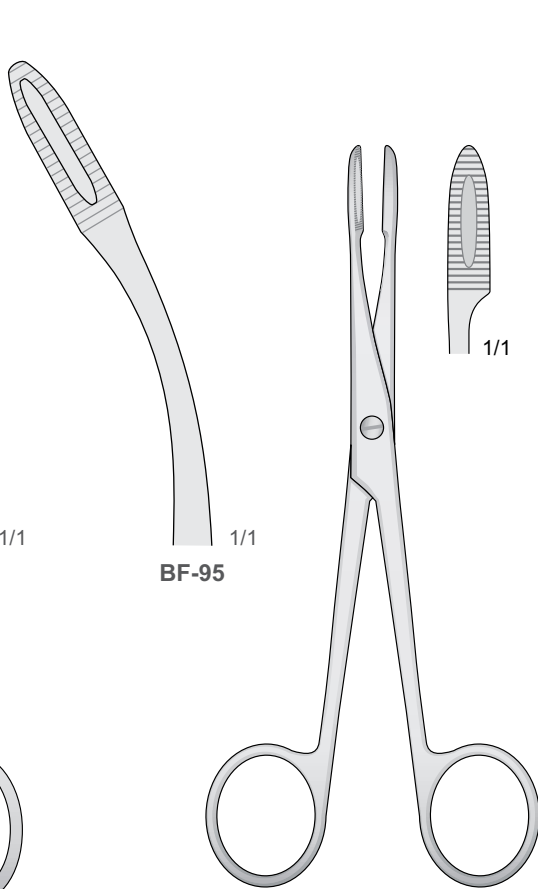

GROSS
BF-10 130 mm
BF-12 160 mm

Sinus klemmen
Sinus forceps
Pinze Sinus
Pinzas para seno
Pincas à Sinus

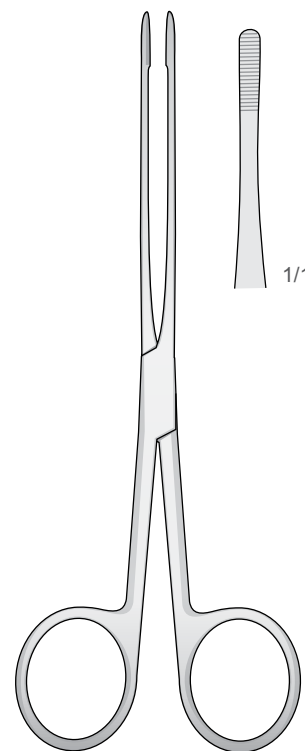

LISTER
BF-20
150 mm

Hemostatic Forceps

Arterienklemmen
Pinze emostatiche
Pinzas hemostáticas
Pincas hémostatiques

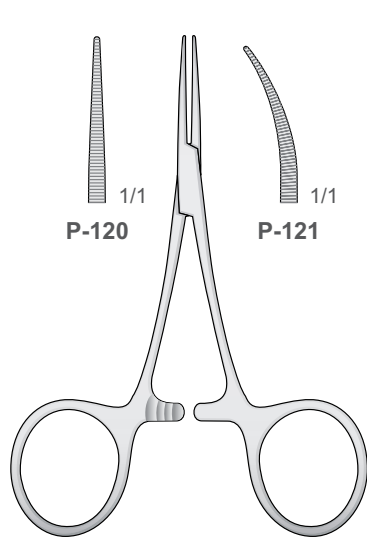

HARTMANN/BABY-MOSQUITO
P-120/P-121
95 mm

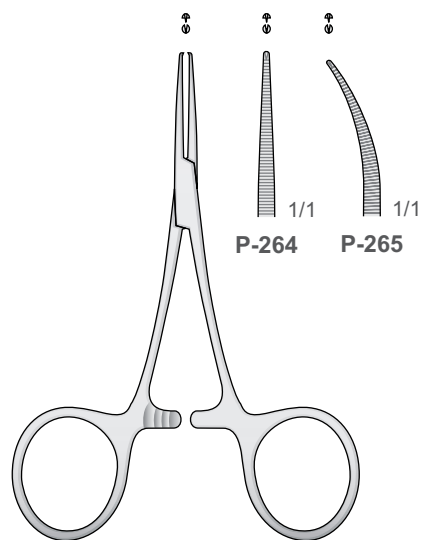

HARTMANN/BABY-MOSQUITO
P-264/P-265
95 mm

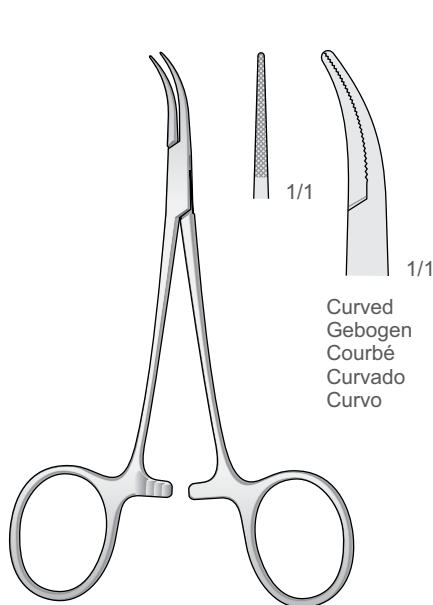

DANDY-MOSQUITO
P-332
120 mm

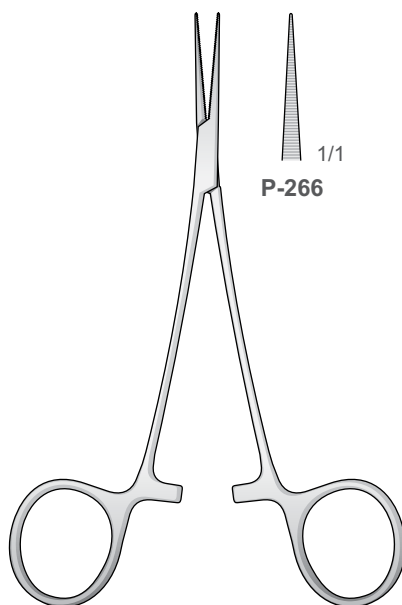

JACOBSON-MICRO
P-266
130 mm

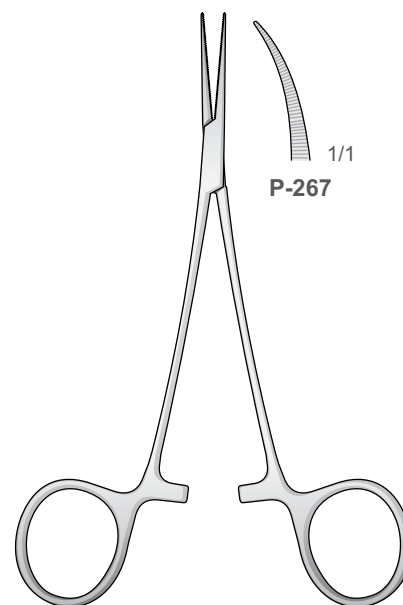

JACOBSON-MICRO
P-267
130 mm

Hemostatic Forceps

Arterienklemmen
Pinze emostatiche
Pinzas hemostáticas
Pincas hémostatiques

Hemostats /Grasping Forceps

Hämostatika / Greifen
Hémostats / Saisir
Emostatici / Presa
Krovoostanavlivayushchiye

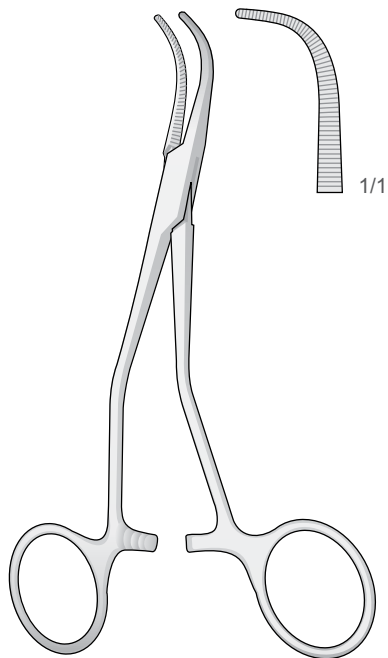

P-15
130 mm

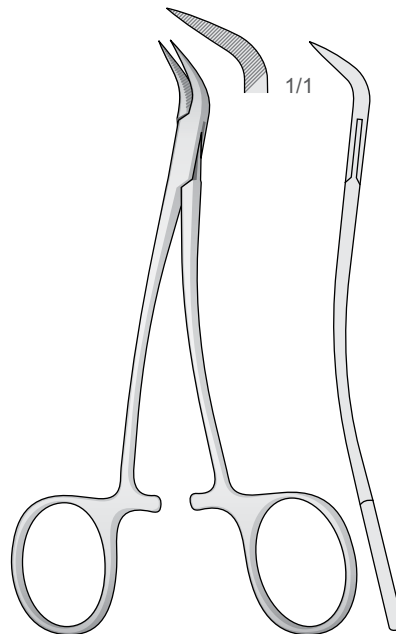

**PEET
DR-40**
120 mm

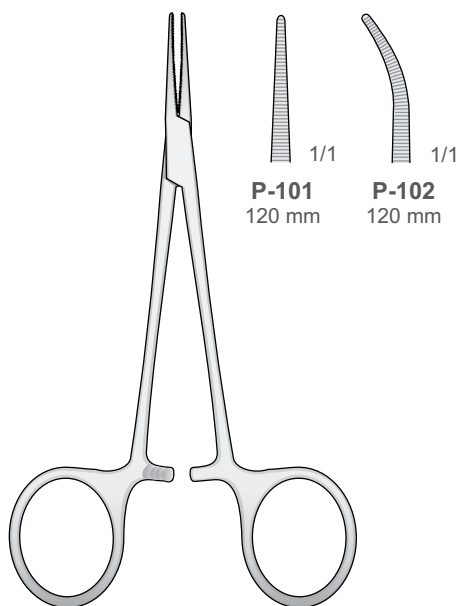

**MICRO-HALSTED
P-101/P-102**

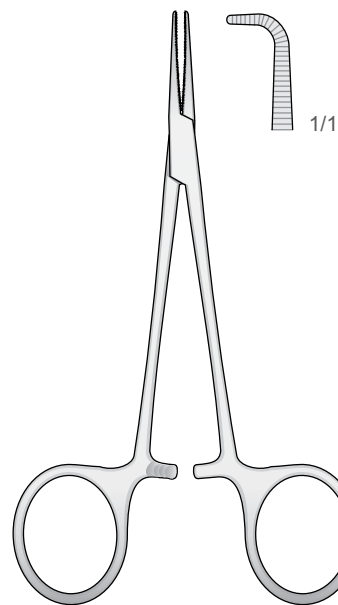

**MICRO-HALSTED
P-135**
115 mm

Hemostatic Forceps

Arterienklemmen
Pinze emostatiche
Pinzas hemostáticas
Pincas hémostatiques

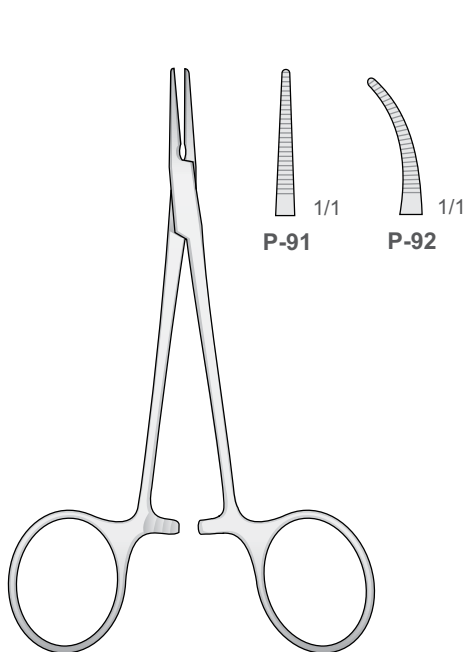

HALSTED
P-91/P-92
125 mm

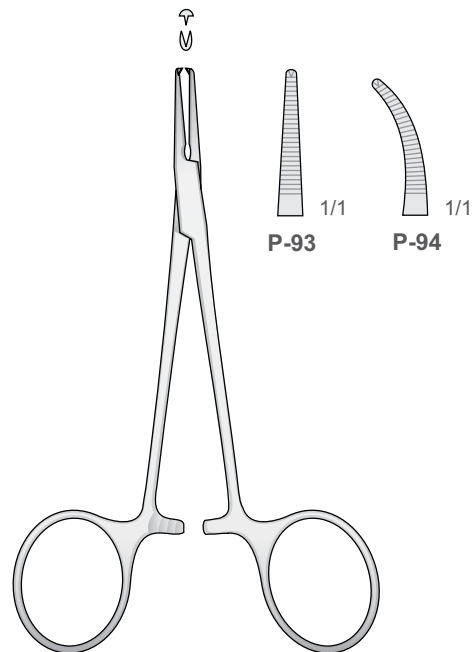

HALSTED
P-93/P-94
125 mm

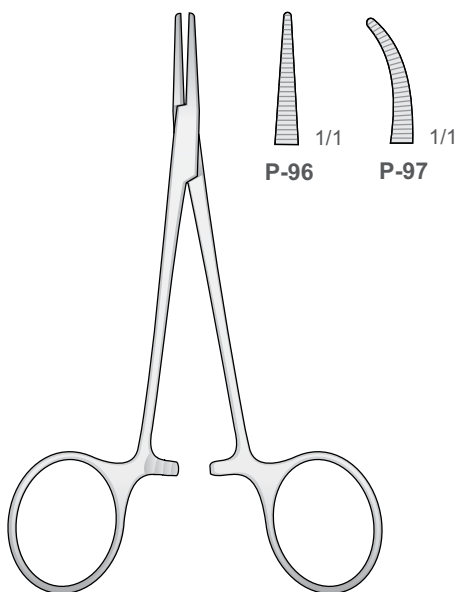

HALSTED-MOSQUITO
P-96/P-97
120 mm

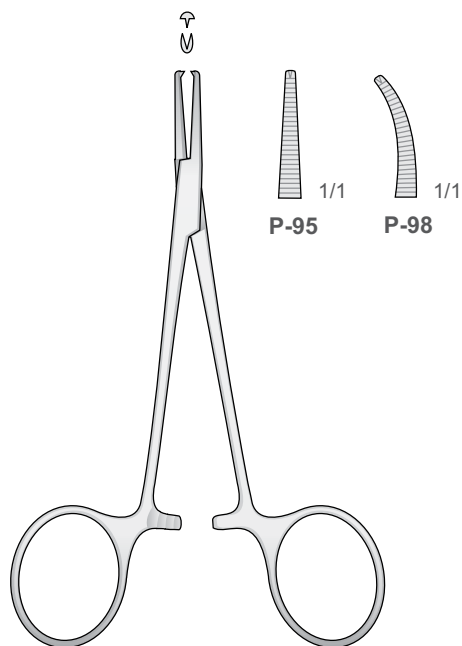

HALSTED-MOSQUITO
P-95/P-98
120 mm

Hemostatic Forceps

Arterienklemmen
Pinze emostatiche
Pinzas hemostáticas
Pincas hémostatiques

Hemostats /Grasping Forceps

Hämostatika / Greifen
Hémostats / Saisir
Emostatici / Presa
Krovoostanavlivayushchiye

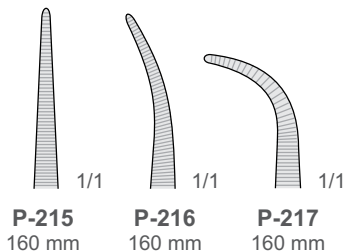
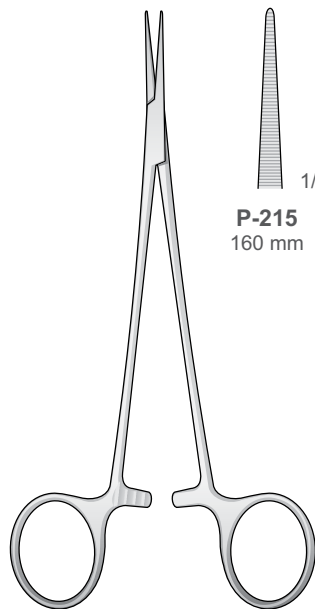

P-215/P-217
160 mm

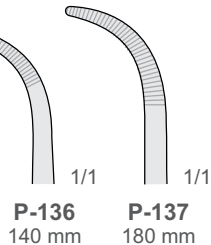
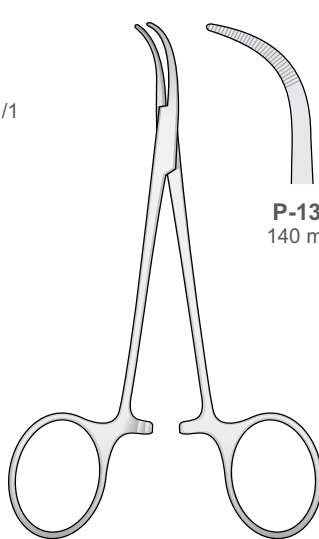

BABY-MIXTER
P-136/P-137

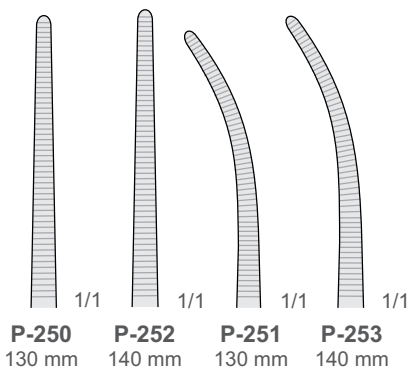
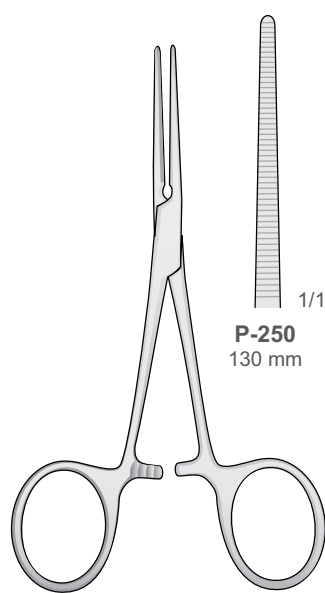

PEAN
P-250/P-253

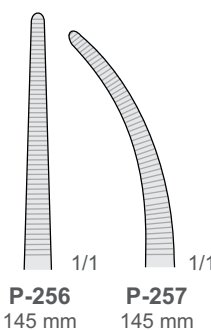
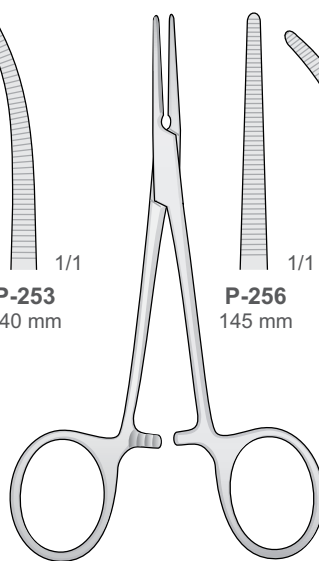

PEAN
P-256/P-257

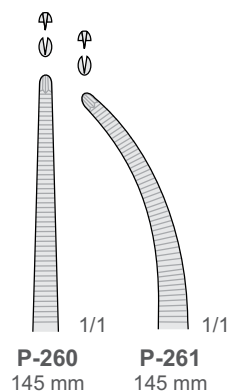
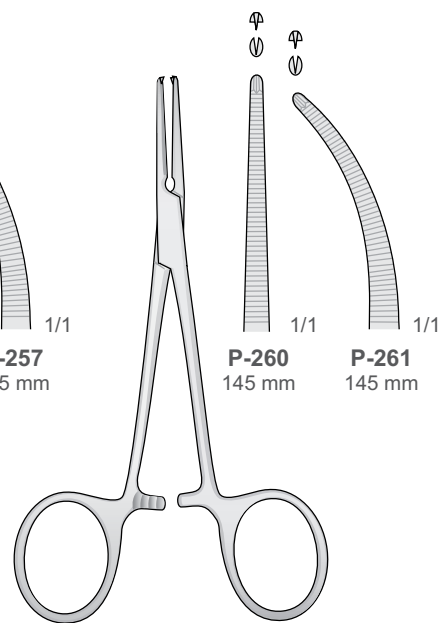

KOCHER
P-260/P-261

Hemostatic Forceps

Arterienklemmen
Pinze emostatiche
Pinzas hemostáticas
Pincés hémostatiques

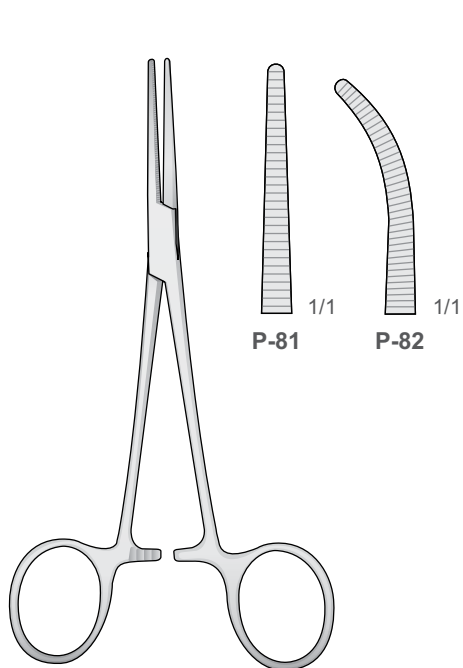

CRILE
P-81/P-82
140 mm

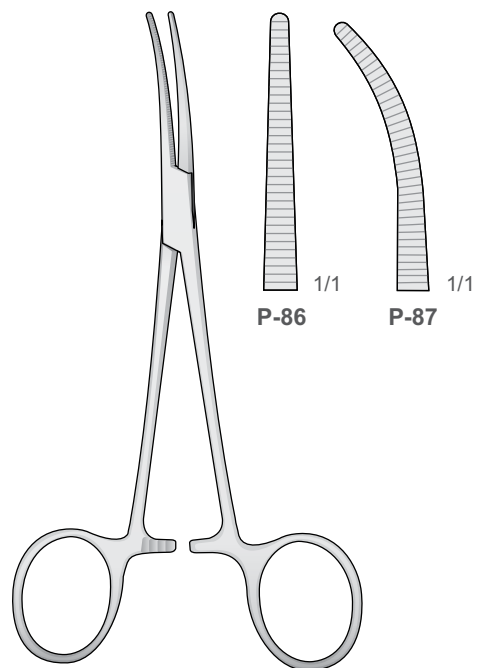

CRILE
P-86/P-87
160 mm

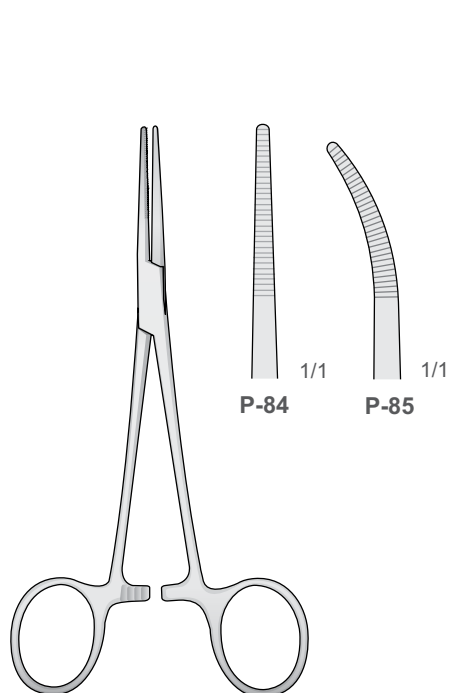

KELLY
P-84/P-85
140 mm

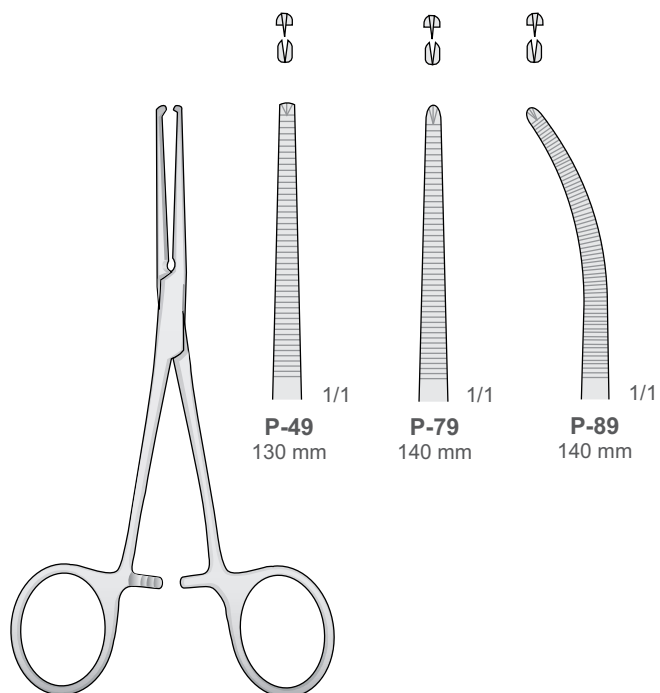

KOCHER
P-49/P-89
130 mm

Hemostatic Forceps

Arterienklemmen
 Pinze emostatiche
 Pinzas hemostáticas
 Pincas hémostatiques

Hemostats /Grasping Forceps

Hämostatika / Greifen
 Hémostats / Saisir
 Emostatici / Presa
 Krovoostanavlivayushchiye

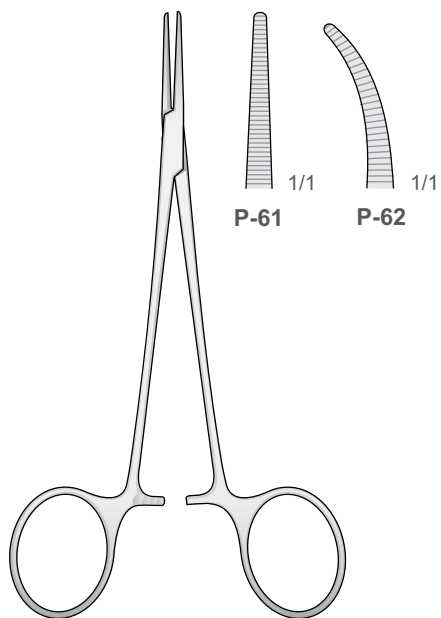

LERICHE
P-61/P-62
 150 mm

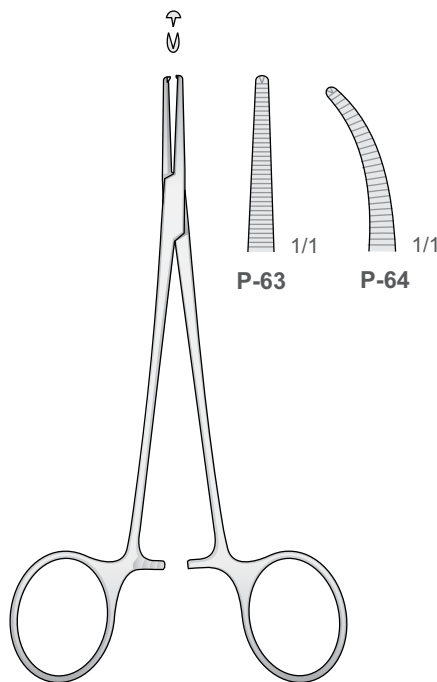

LERICHE
P-63/P-64
 150 mm

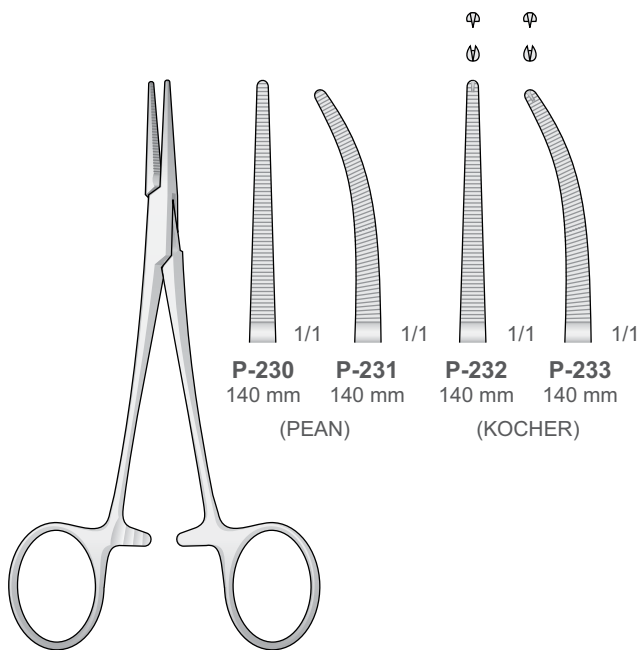

BABY-CRILE
P-230/P-233
 140 mm

P-230 140 mm
P-231 140 mm
 (PEAN)

P-232 140 mm
P-233 140 mm
 (KOCHER)

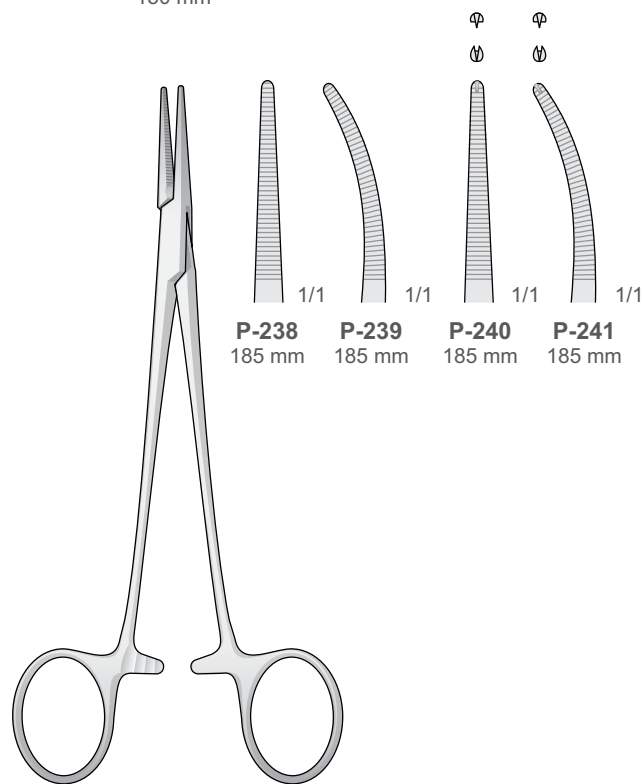

HALSTED
P-238/P-241
 185 mm

P-238 185 mm
P-239 185 mm
P-240 185 mm
P-241 185 mm

Tissue Grasping Forceps

Gewebefasszangen
Pinze per tessuti
Pinzas para tejidos
Pinces pour tissus

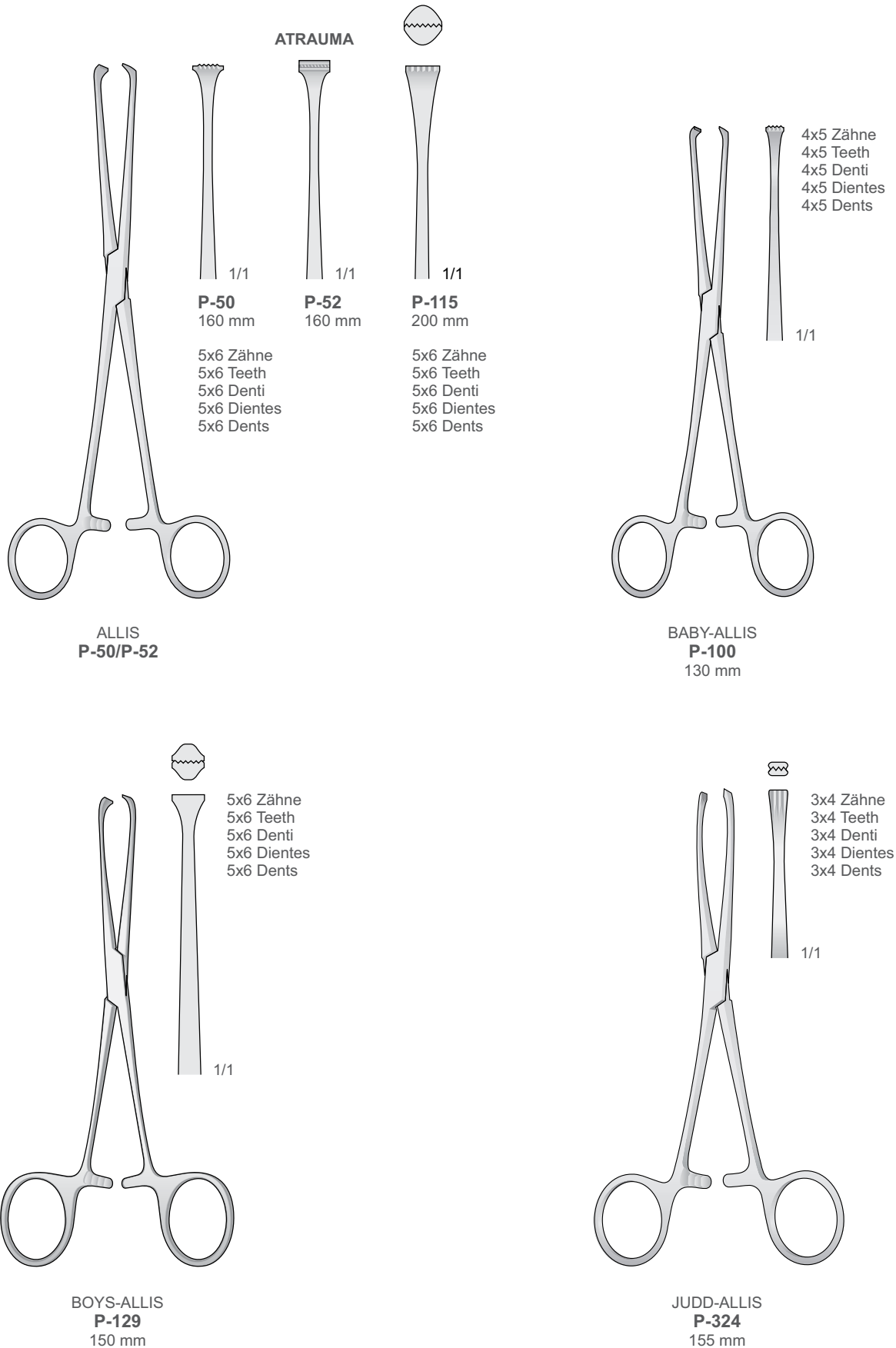

MSB

RETRACTORS



Retractors

Wundhaken
Separadores
Ecarteurs
Divaricatori

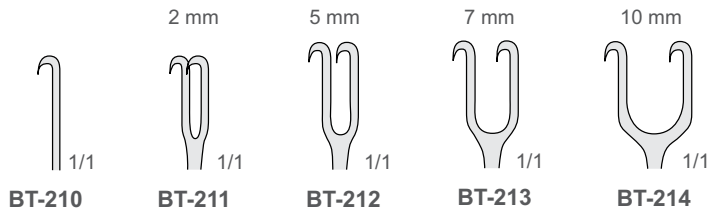
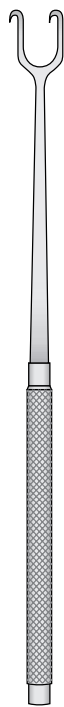
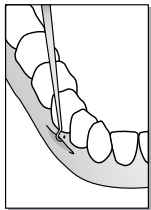

JOSEPH
BT-210/BT-214
160 mm

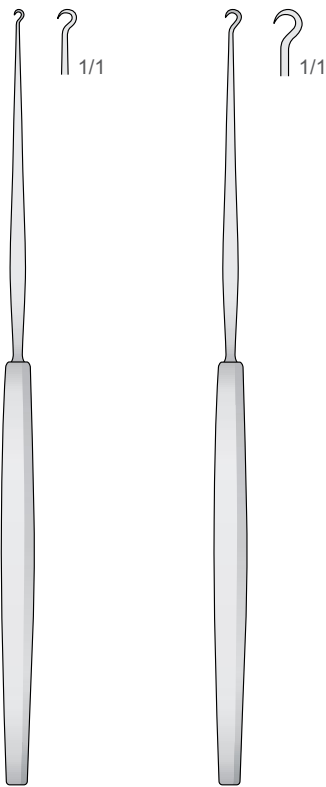

GILLIES
BT-15
180 mm

GILLIES
BT-16
180 mm



MINI-LANGENBECK
BT-186/BT-189
160 mm

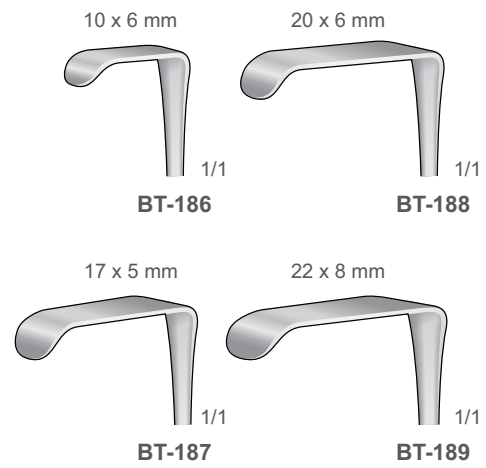

Retractors

Wundhaken
Separadores
Ecarteurs
Divaricatori

Retractors

Wundhaken
Separadores
Ecarteurs
Divaricatori

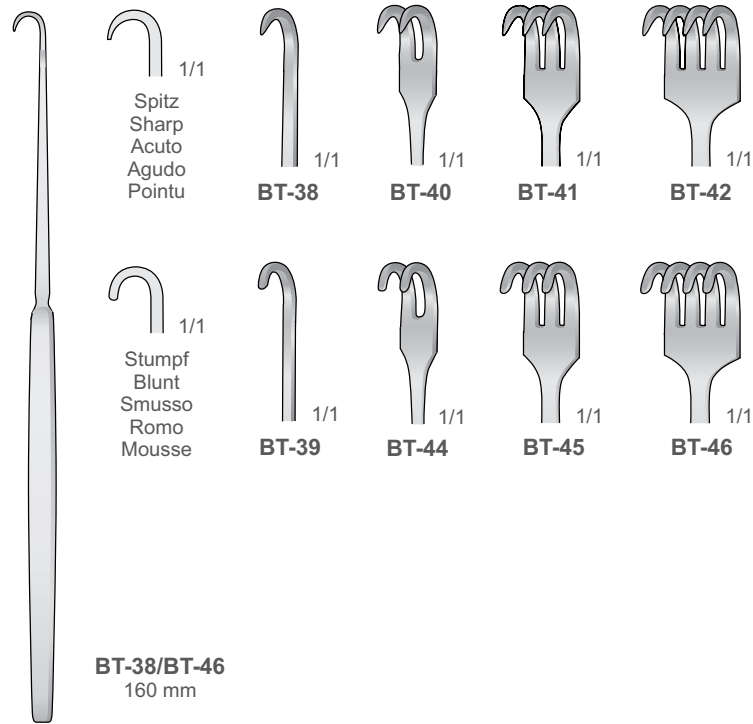

Feine wundhaken flexibel-spitz
Delicate retractors flexible-sharp
Divaricatori delicati flessibili-acuti
Separadores finos flexibles-agudos
Écarteurs fins pointu flexible

Feine wundhaken flexibel-stumpf
Delicate retractors flexible-blunt
Divaricatori delicati flessibili-smussi
Separadores finos flexibles-romos
Écarteurs fins mousse flexible

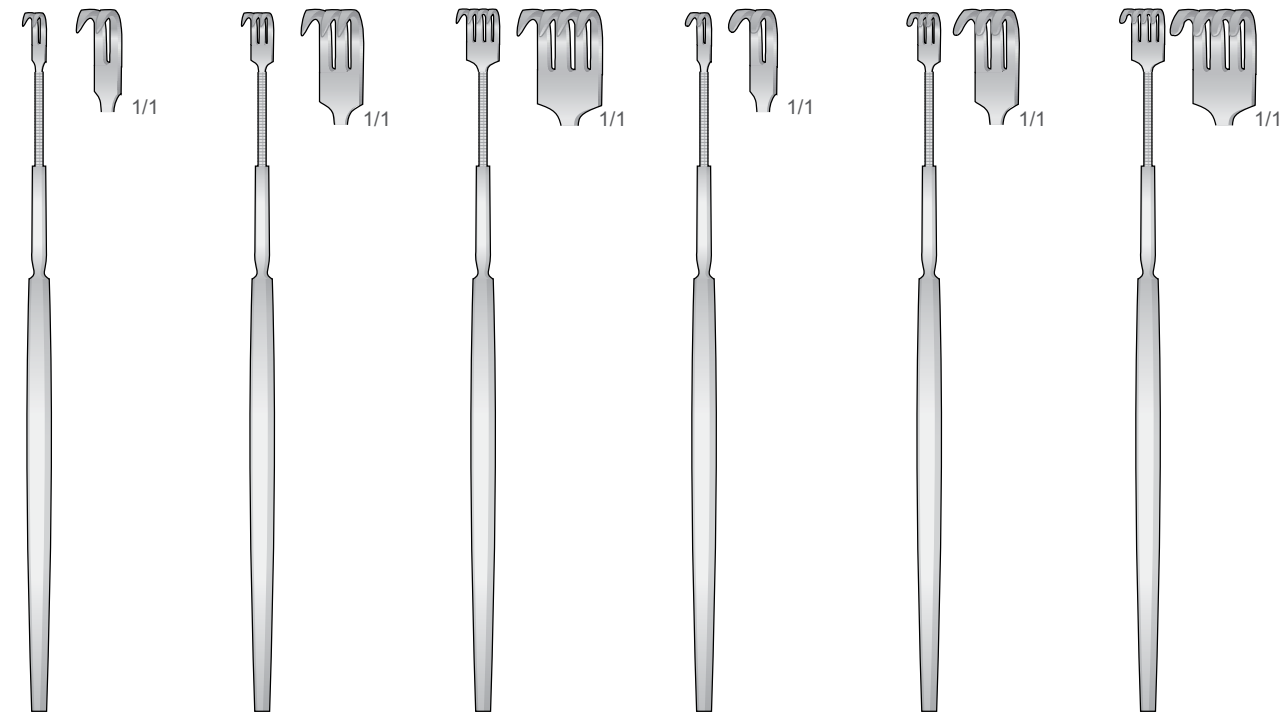

BT-50
150 mm

BT-51
150 mm

BT-52
150 mm

BT-54
150 mm

BT-55
150 mm

BT-56
150 mm

Retractors

Wundhaken
Separadores
Ecarteurs
Divaricatori

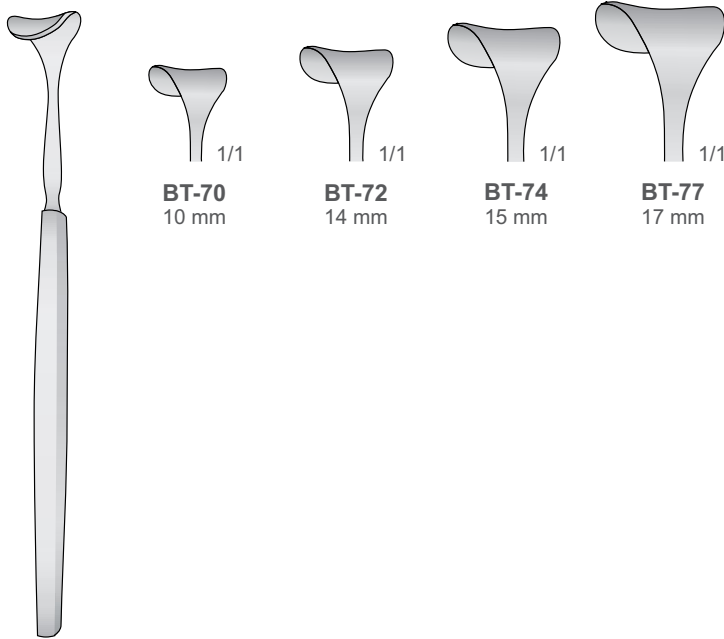

BT-70
10 mm

BT-72
14 mm

BT-74
15 mm

BT-77
17 mm

DESMARRES
BT-70/BT-77
140 mm

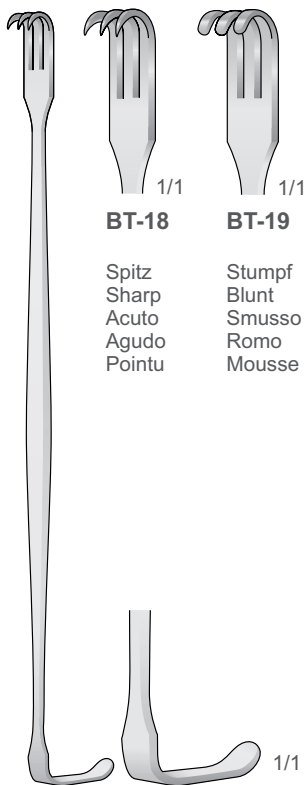

BT-18

BT-19

Spitz
Sharp
Acuto
Agudo
Pointu

Stumpf
Blunt
Smusso
Romo
Mousse

SEÁN-MILLER
BT-18/BT-19
160 mm

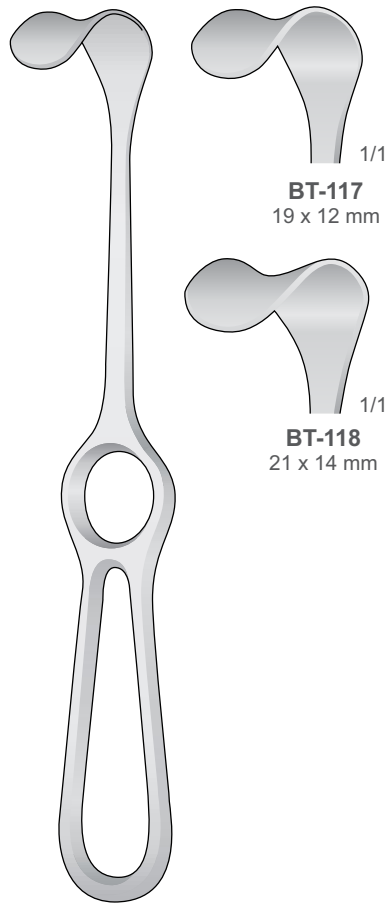

BT-117
19 x 12 mm

BT-118
21 x 14 mm

KOCHER
BT-117/BT-118
205 mm

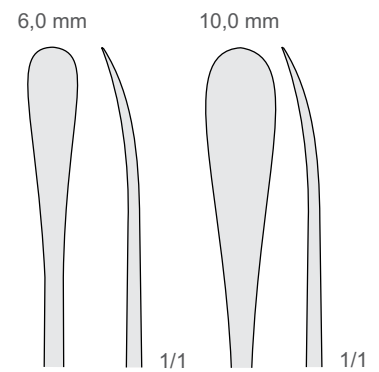

6,0 mm

10,0 mm



HURD
BT-1/BT-2
220 mm

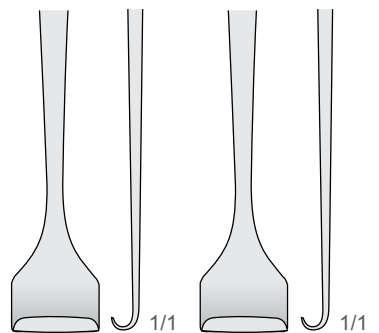

12 mm

12 mm

Retractors

Wundhaken
Separadores
Ecarteurs
Divaricatori

Retractors

Wundhaken
Separadores
Ecarteurs
Divaricatori

Retractors
Divaricatori
Separadores
Écarteurs

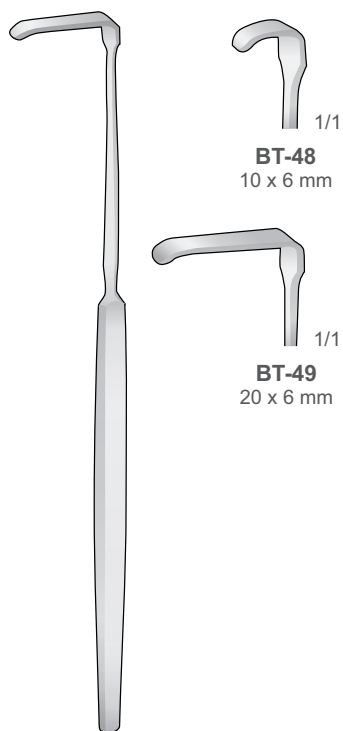

SENN GREEN
BT-48/BT-49
160 mm

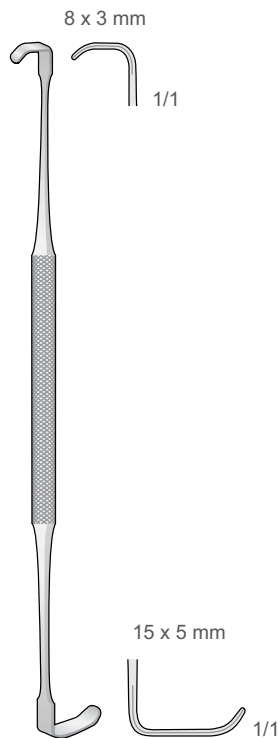

RAGNELL
BT-27
140 mm

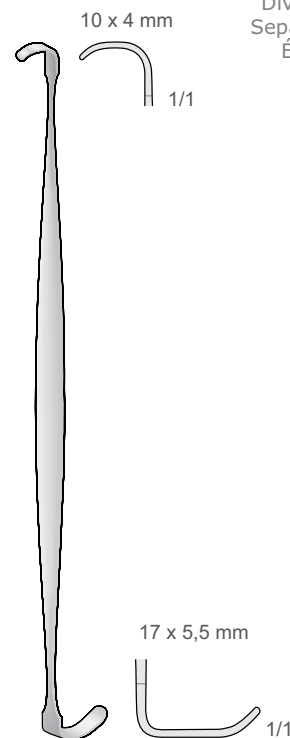

RAGNELL-DAVIS
BT-26
140 mm

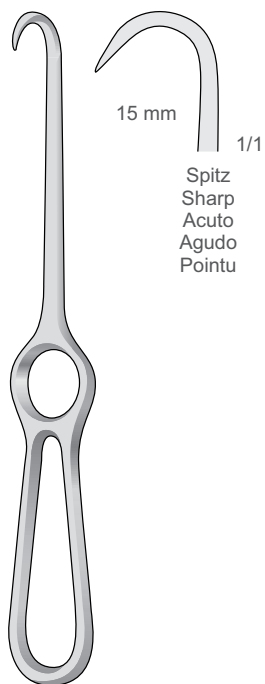

KOCHER
BT-139
205 mm

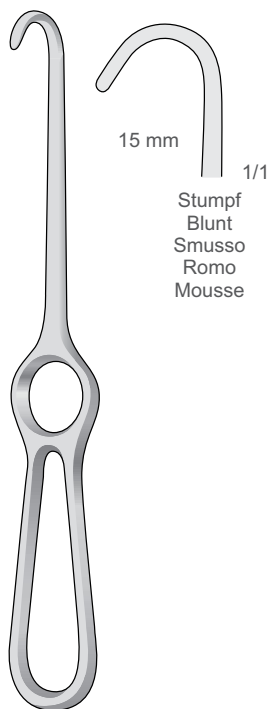

KOCHER
BT-140
220 mm



LAHEY
BT-109
195 mm

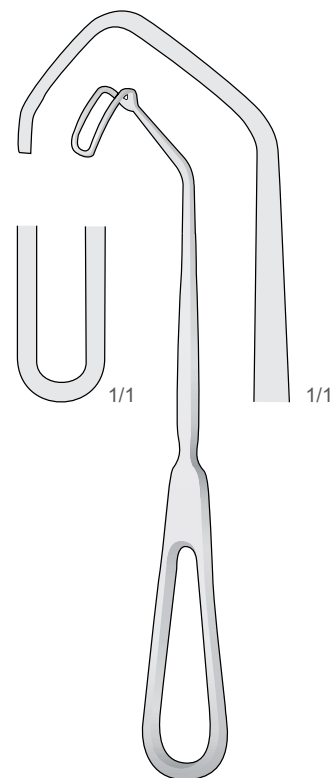

CUSHING
BT-29
200 mm

Retractors

Wundhaken
Separadores
Ecarteurs
Divaricatori

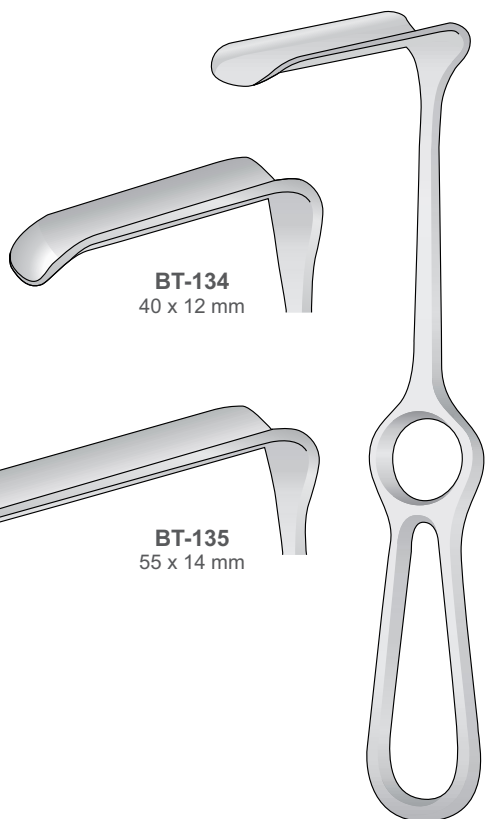
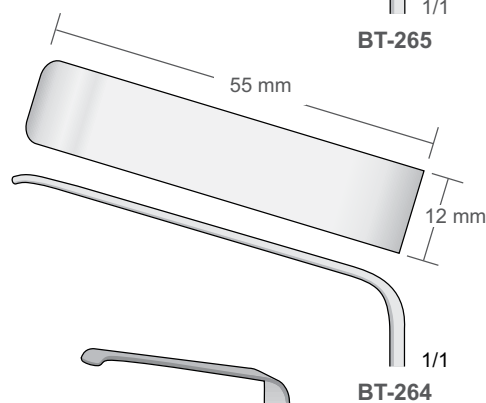
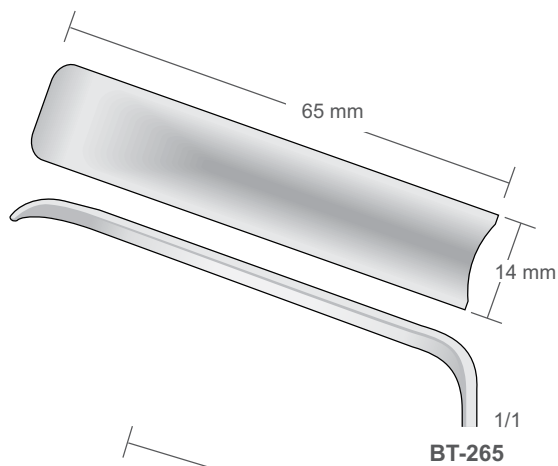

DOCKHORN
BT-134/BT-135
210 mm

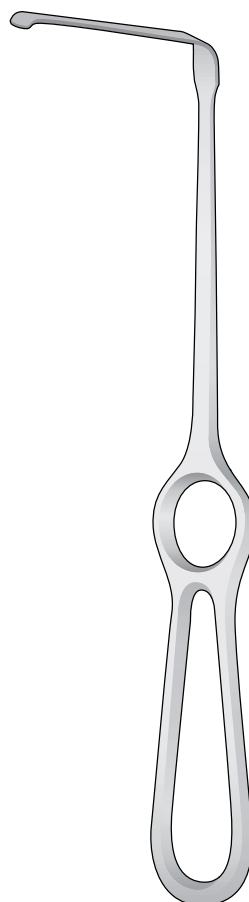

BT-264/BT-265
235 mm

Retractors

Wundhaken
Separadores
Ecarteurs
Divaricatori

Retractors

Wundhaken
Separadores
Ecarteurs
Divaricatori

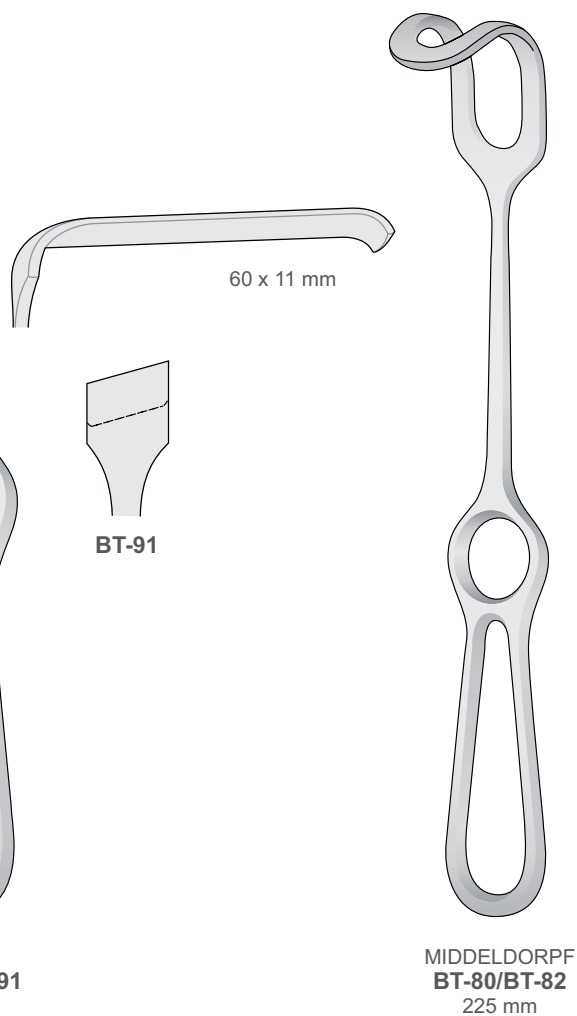
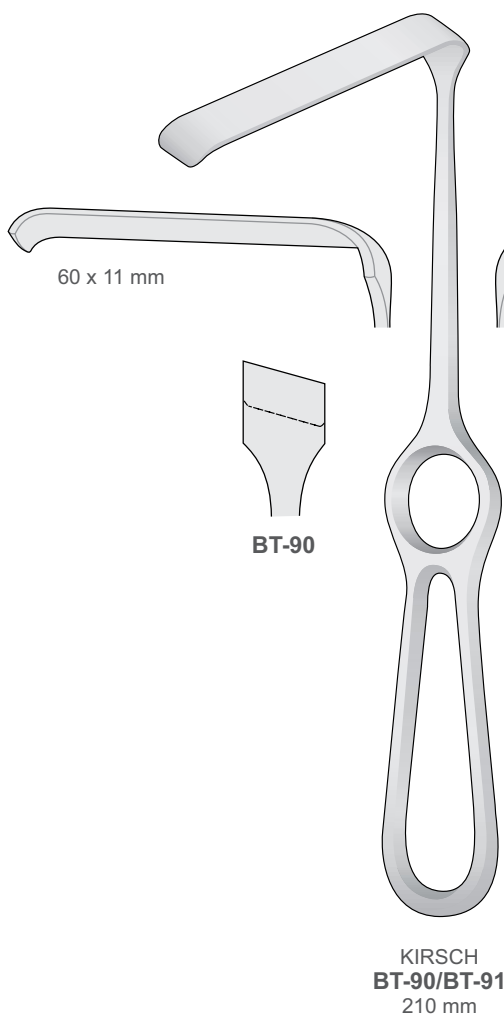

Retractors

Wundhaken
Separadores
Ecarteurs
Divaricatori

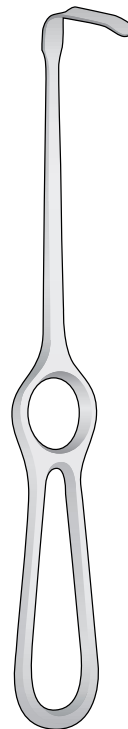
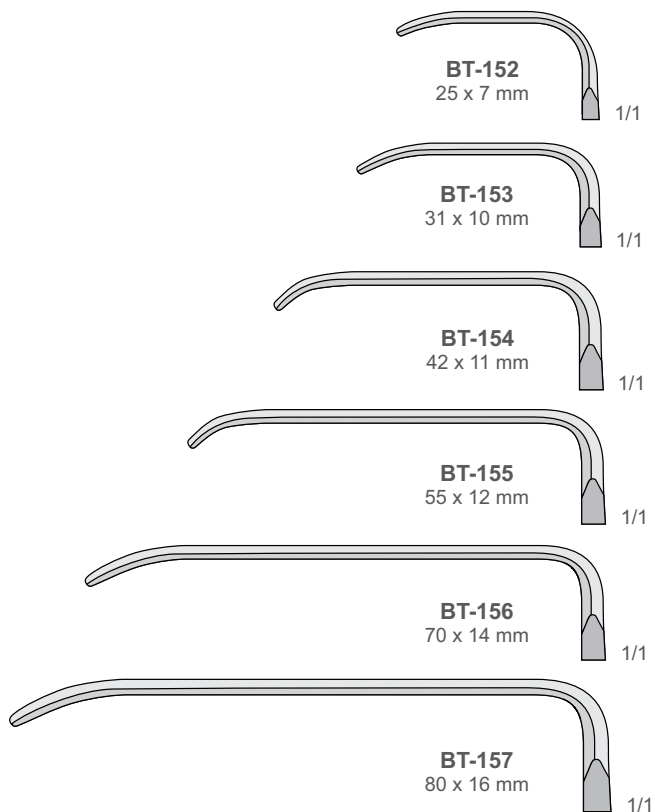

OBWEGESER
BT-152/BT-157
220 mm

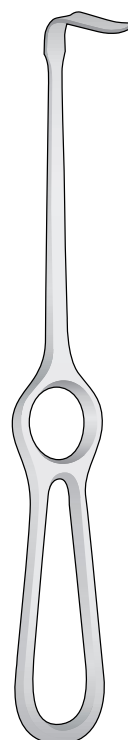
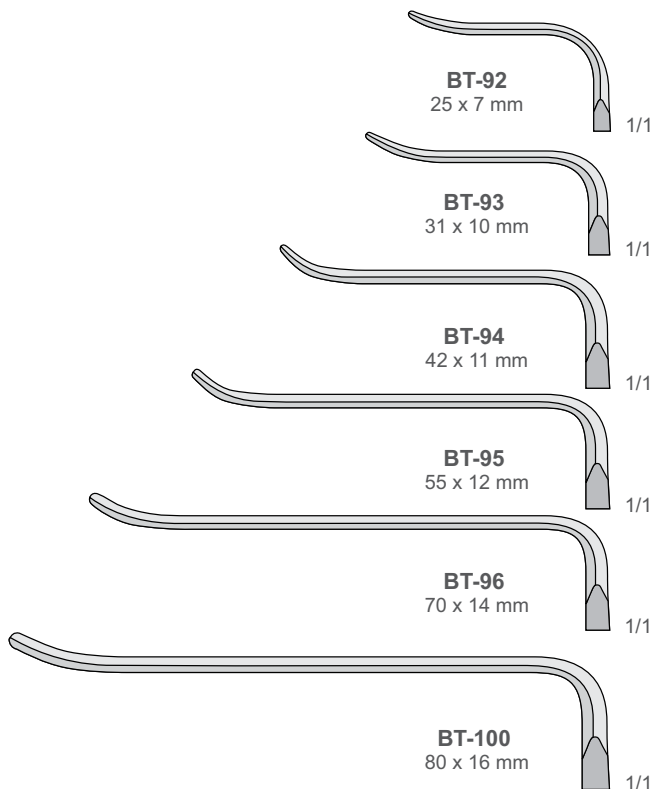

OBWEGESER
BT-92/BT-100
220 mm

Retractors

Wundhaken
Separadores
Ecarteurs
Divaricatori

Retractors

Wundhaken
Separadores
Ecarteurs
Divaricatori

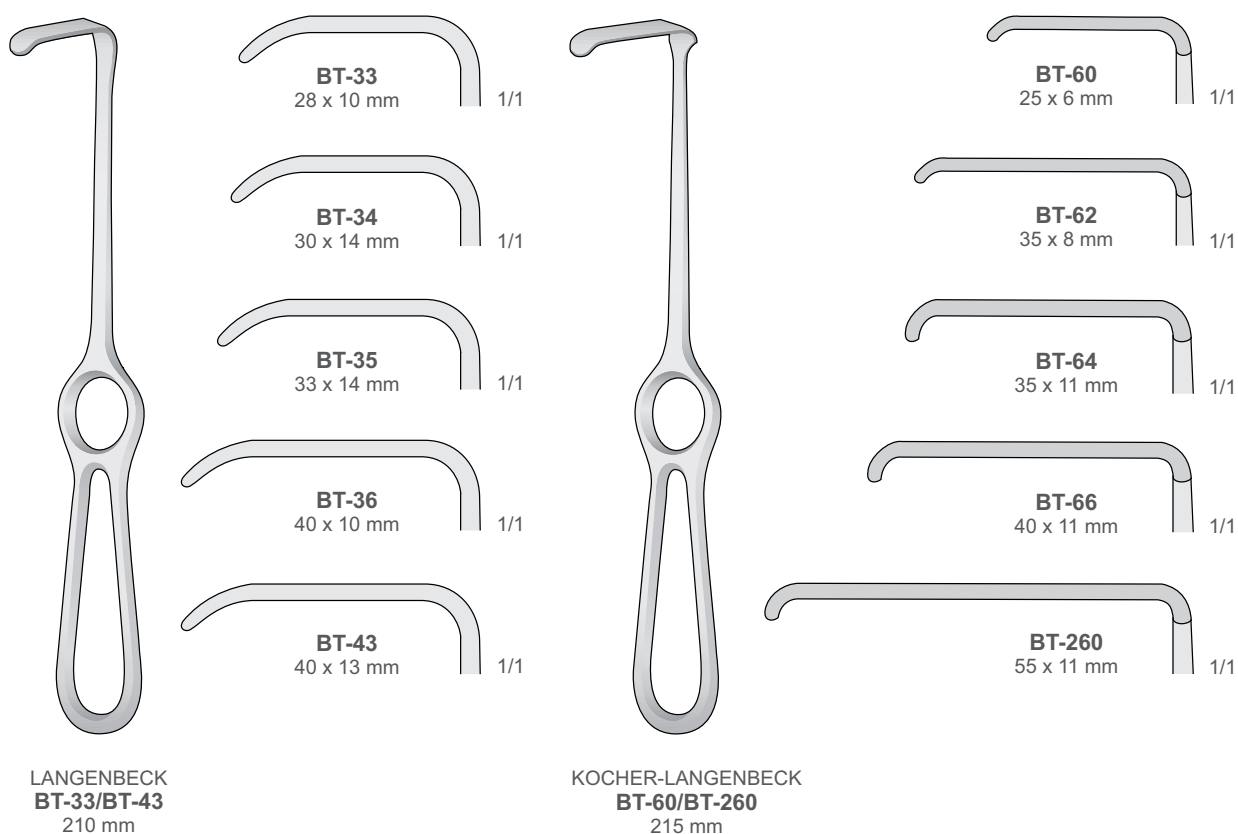
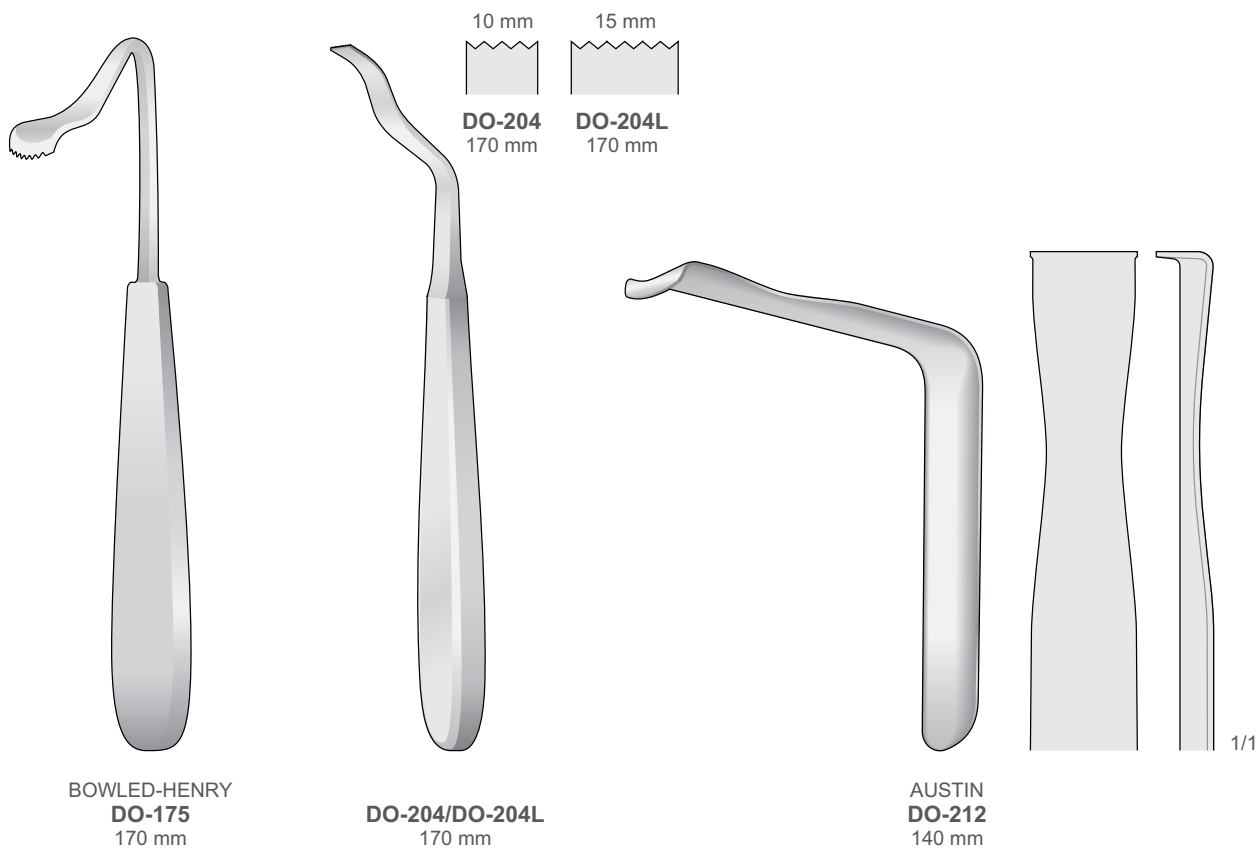

Retractors

Wundhaken
Separadores
Ecarteurs
Divaricatori

Rostfrei - Stainless Steel
Acciaio - Acero - Acer

Biegsam - Malleable
Malleabili - Maleables
Souples

OM-85
Komplettset mit 3 Spatel
Set complete with 3 spatulas
Set completo con 3 spatole
Set completos con 3 espátulas
Set complete avec 3 spatules
OM-80 + OM-81 + OM-82

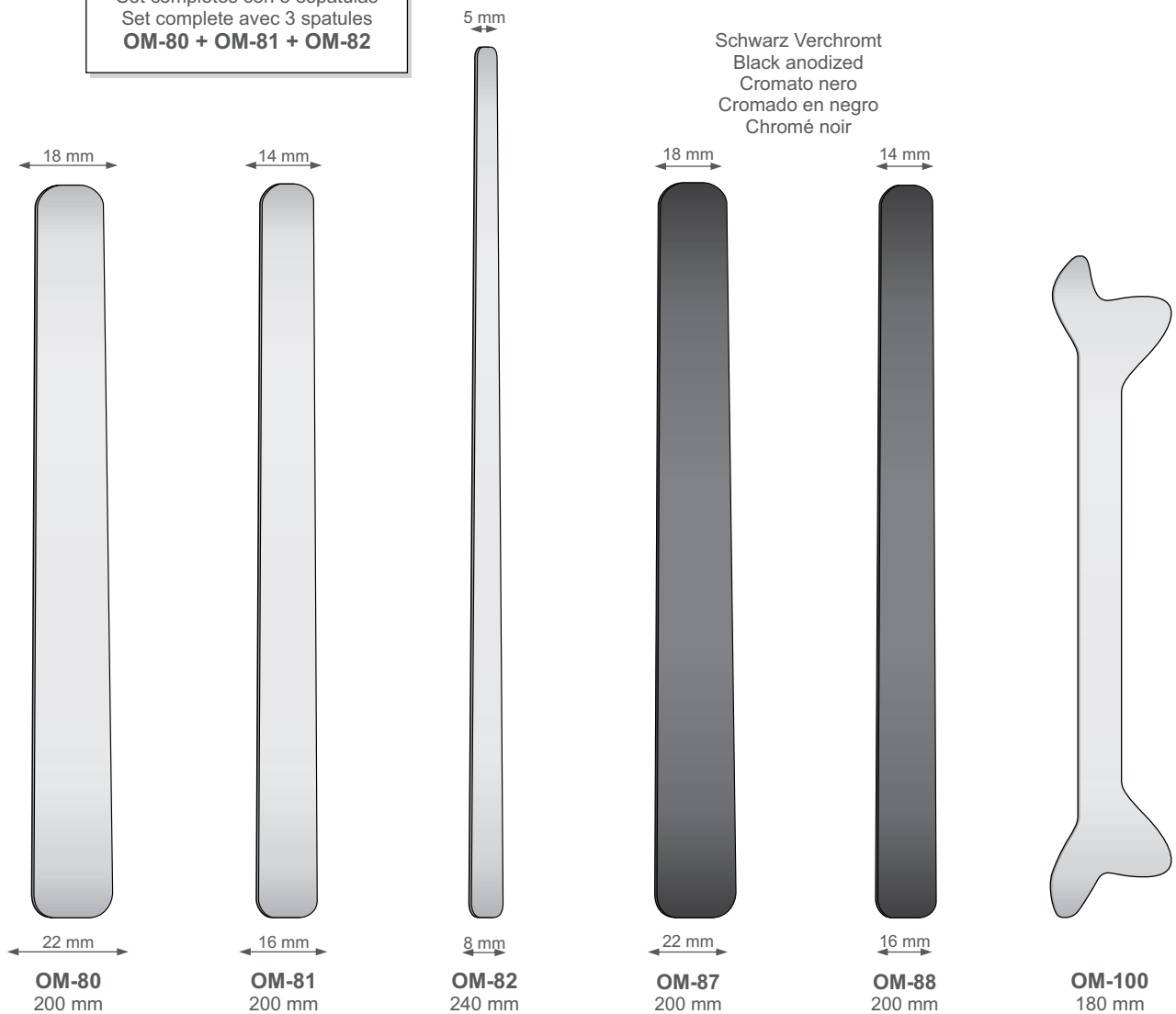

Retractors

Wundhaken
Separadores
Ecarteurs
Divaricatori

Retractors

Wundhaken
Separadores
Ecarteurs
Divaricatori

Zungendrucker
Tongue Depressors
Abbassalingua
Bajalengua
Abaisse langue

Kinnhalter
Chin Holder
Divaricatore per mento
Separador para mentón
Écarteur pour menton

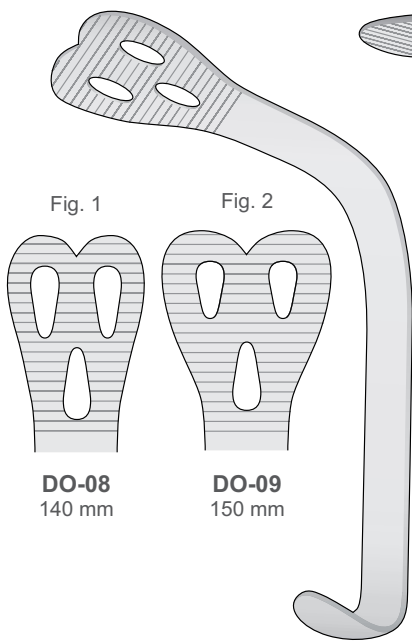
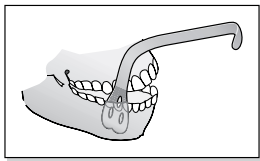

Fig. 1

Fig. 2

DO-08
140 mm

DO-09
150 mm

WIEDER
DO-08/DO-09

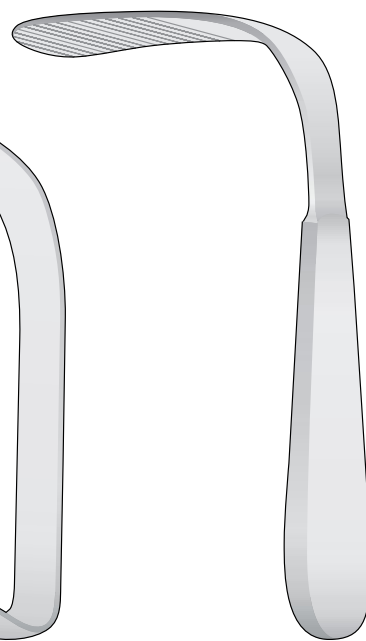

TOBOLD
OM-08
145 mm

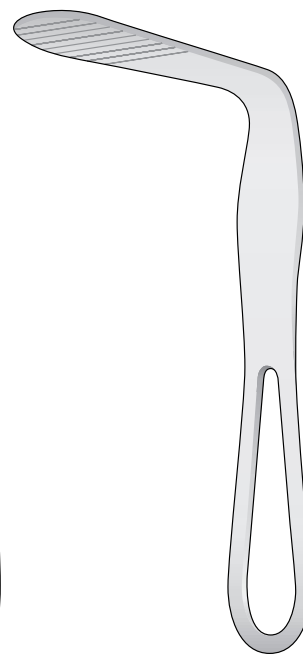

HARTMANN
OM-06
150 mm

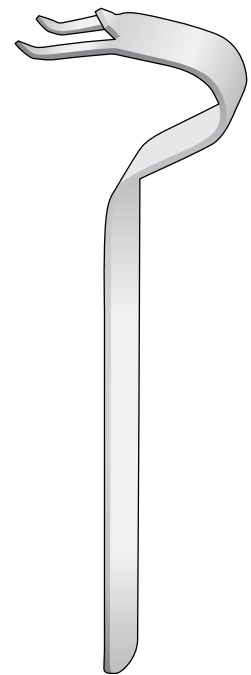

OBWEGESER
DO-40
155 mm

Retractors

Wundhaken
Separadores
Ecarteurs
Divaricatori

Ramushaken für Spina Nasalis
Ramus Retractor for nasal spine
Divaricatori per spina nasalis
Separadores para spina nasalis
Écarteurs pour spina nasalis

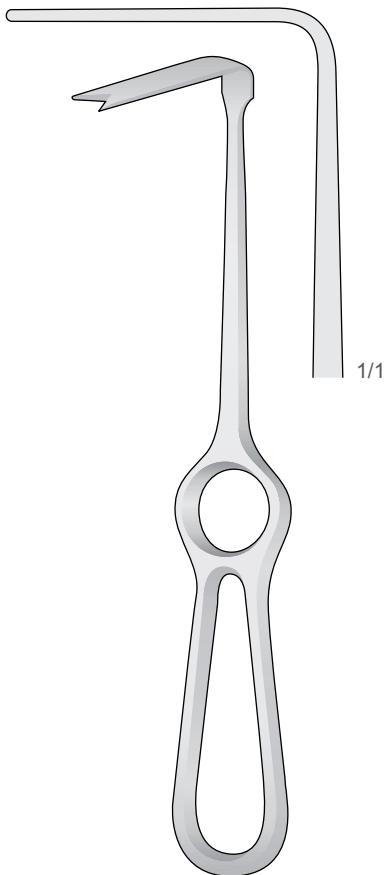

OBWEGESER
BT-67
220 mm

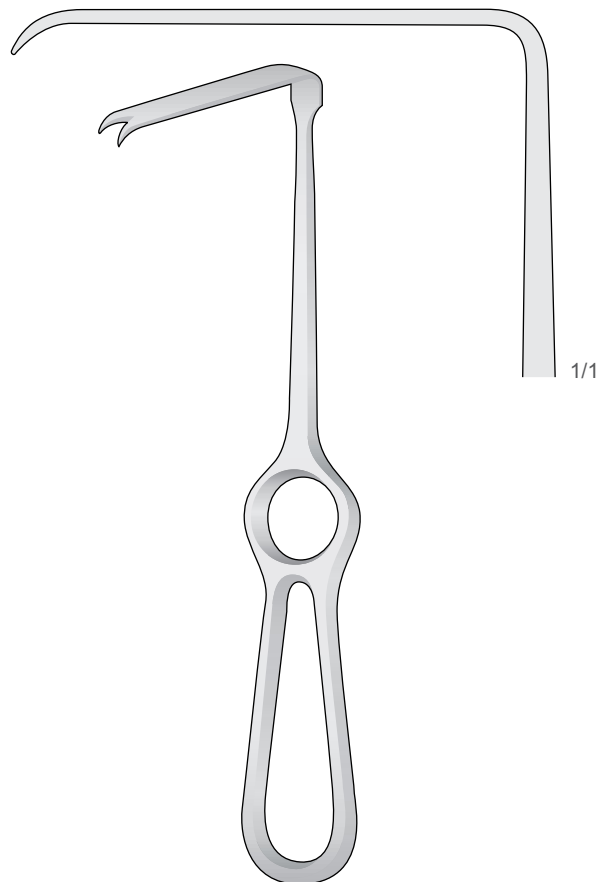
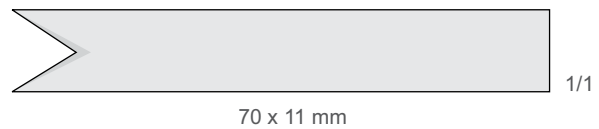

OBWEGESER
BT-68
220 mm

Mouth gags

Mundsperrer
Apribocca
Abrebocas
Écarteur buccal

Retractors

Wundhaken
Separadores
Ecarteurs
Divaricatori

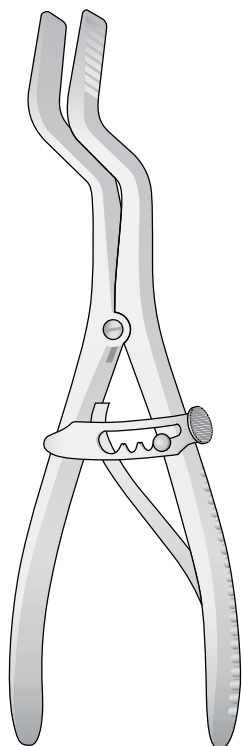

ROSER KÖNIG
OM-60
185 mm



Paar Einsätze aus Silikon für:
Pair of silicone inserts for:
Coppia di inserti in silicone per:
Pareja de inserto de silicone para:
Paire de inserts en silicon pour:

OM-40 - OM-41

Ø 8 mm

Ø 11 mm



OM-40R
30 mm



OM-41R
30 mm

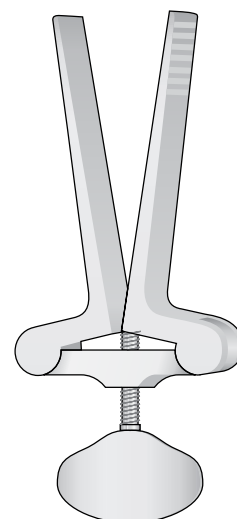

HEISTER
OM-62
135 mm

Für Erwachsene - For adults
Per adulti - Para adultos
Pour adultes

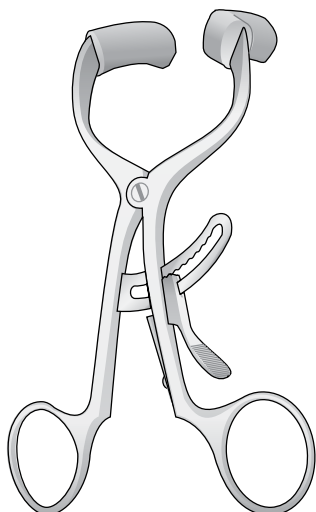

MOLT
DOYEN-JANSEN
OM-41
140 mm

Für Erwachsene - For adults
Per adulti - Para adultos
Pour adultes

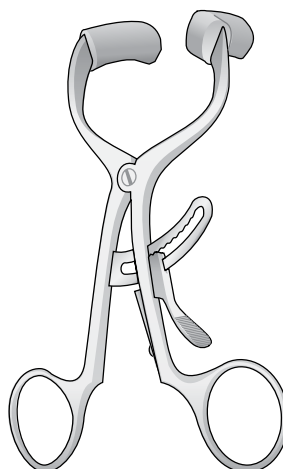

MOLT
DOYEN-COLLIN
OM-40
120 mm

Für Kinder
For children
Per bambini
Para niños
Pour enfants

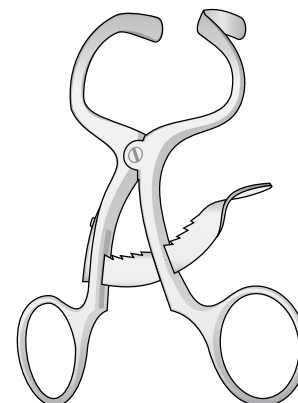

MOLT
OM-42
100 mm

Mouth gags

Mundsperrer
Apribocca
Abrebocas
Écarteur buccal

Abhalter für gesamten Ober- bzw. Unterkiefer
Retractor for complete upper resp. Lower jaws
Retratore per arcata superiore e inferiore intera
Separadores para quijadas enteras inferiores y superiores
Écarteurs pour machoires complètes inférieures et supérieures

- OM-74** Fig. 0 100 x 95 mm
- OM-75** Fig. 1 115 x 105 mm
- OM-76** Fig. 2 115 x 110 mm
- OM-77** Fig. 3 125 x 115 mm

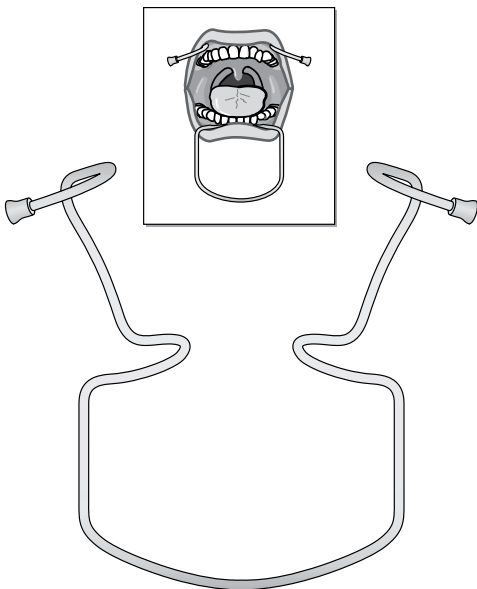

ORINGER
OM-74/OM-77

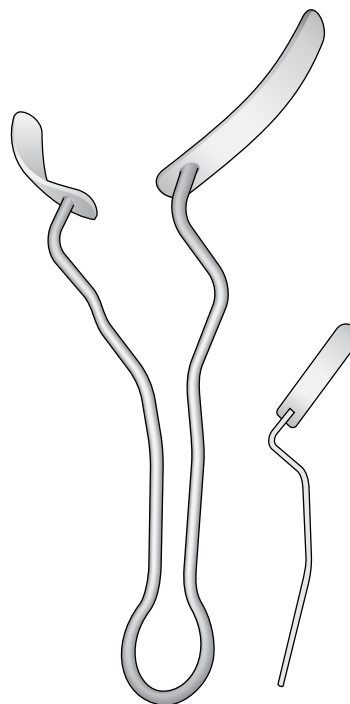

MATY
OM-97
170 mm

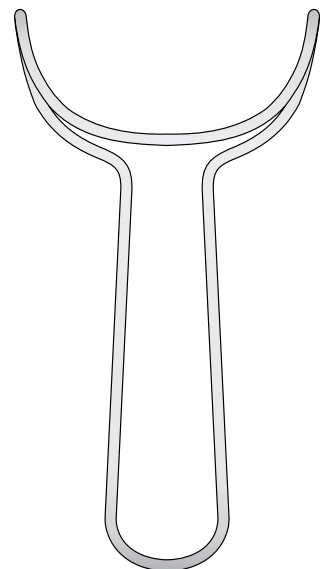

OM-90
150 mm

Retractors

Wundhaken
Separadores
Ecarteurs
Divaricatori

Retractors

Wundhaken
Separadores
Ecarteurs
Divaricatori

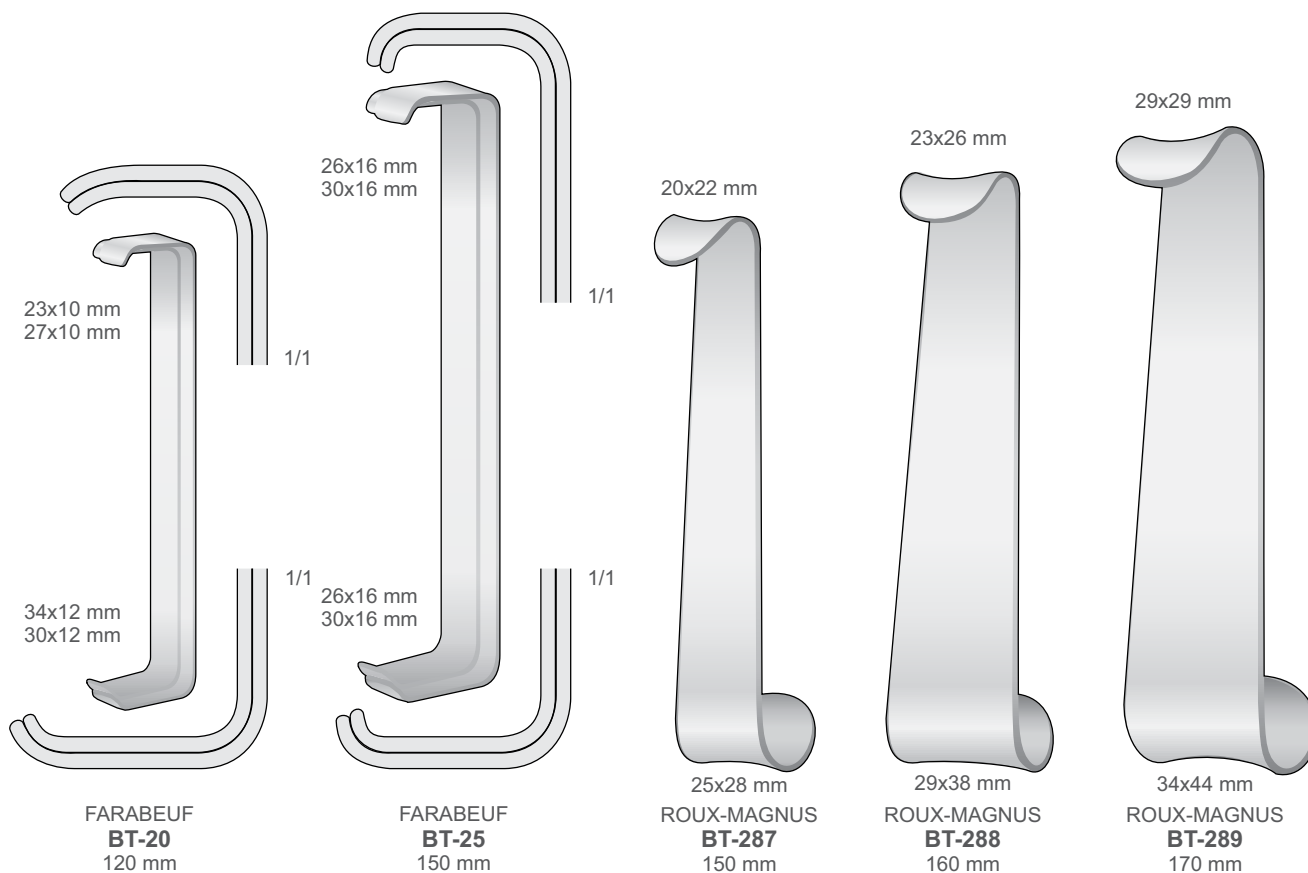
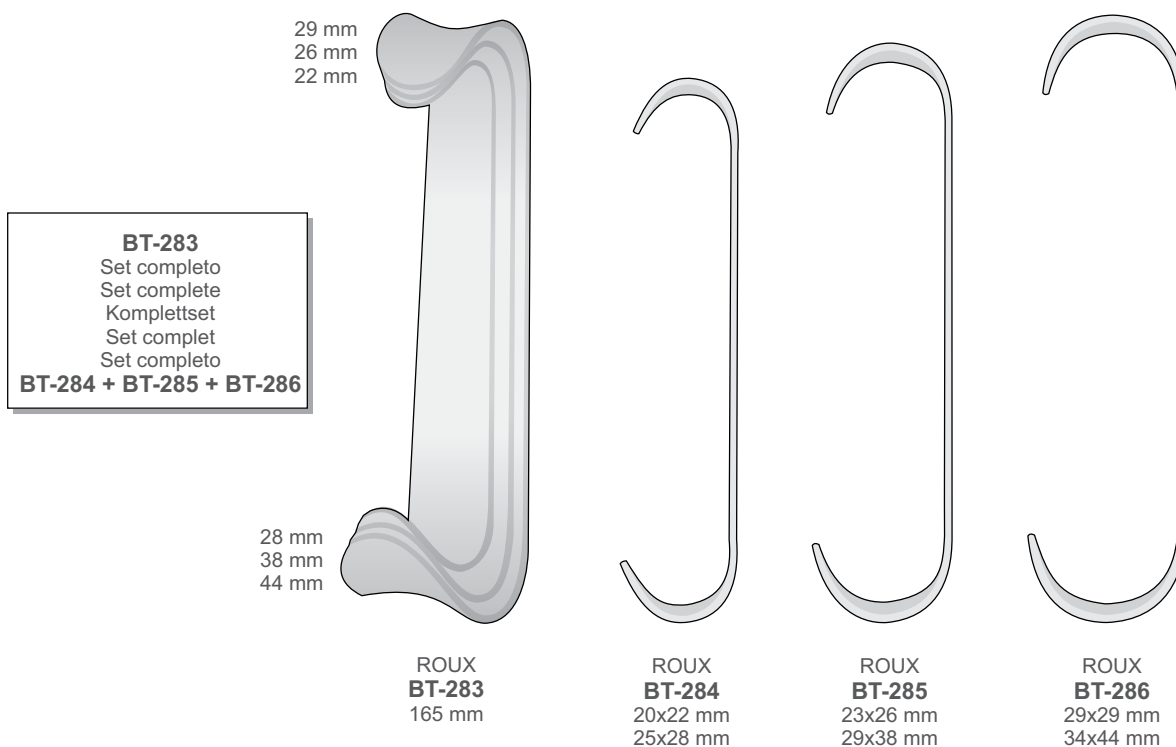

Cheek Retractors

Wangenhalter

Divaricatori per guance

Separador para mejillas

Écarteurs des joues

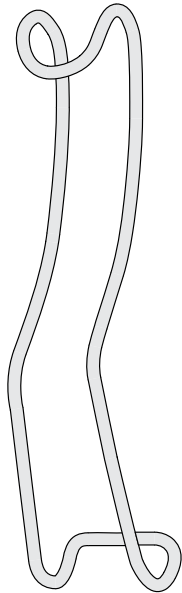

STERNBERG
OM-50
160 mm

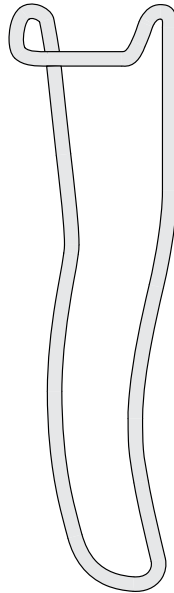

STERNBERG
OM-52
160 mm

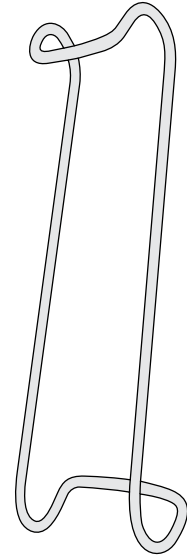

COLUMBIA
OM-67
140 mm

Schwarz Verchromt
Black anodized
Cromato nero
Cromado en negro
Chromé noir

**NEW
BLACK**

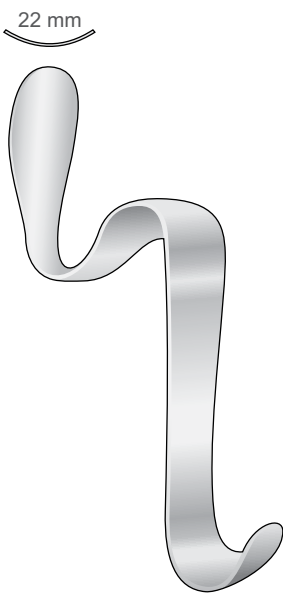

BISHOP
OM-61
130 mm



MINNESOTA
OM-55
140 mm

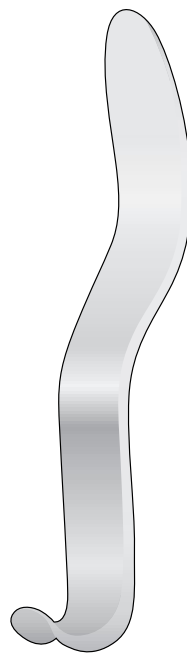

CAWOOD-MINNESOTA
OM-66
160 mm

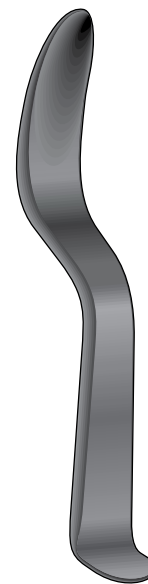

MINNESOTA
OM-55B
140 mm

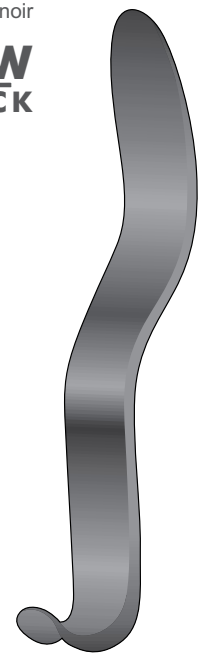

CAWOOD-MINNESOTA
OM-66B
160 mm

Retractors

Wundhaken
Separadores
Ecarteurs
Divaricatori

Retractors

Wundhaken
Separadores
Ecarteurs
Divaricatori

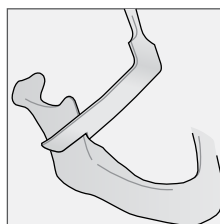

Ramus Retraktoren Recht
Ramus Retractor Right
Retrattore Ramus destro
Separadores Ramus derecho
Écarteur Ramus droites

Ramus Retraktoren Link
Ramus Retractor Left
Retrattore Ramus sinistro
Separadores Ramus izquierdo
Écarteur Ramus gauches

8 mm

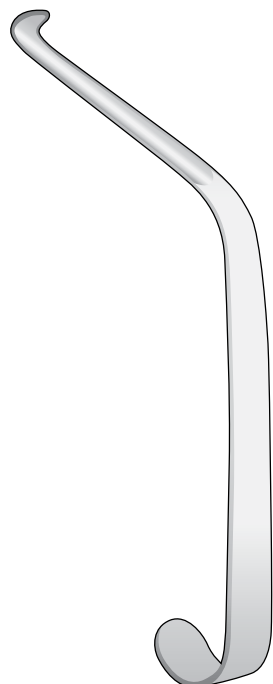

OBWEGESER
DO-41
165 mm

10 mm

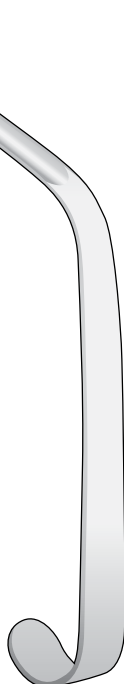

OBWEGESER
DO-142
165 mm

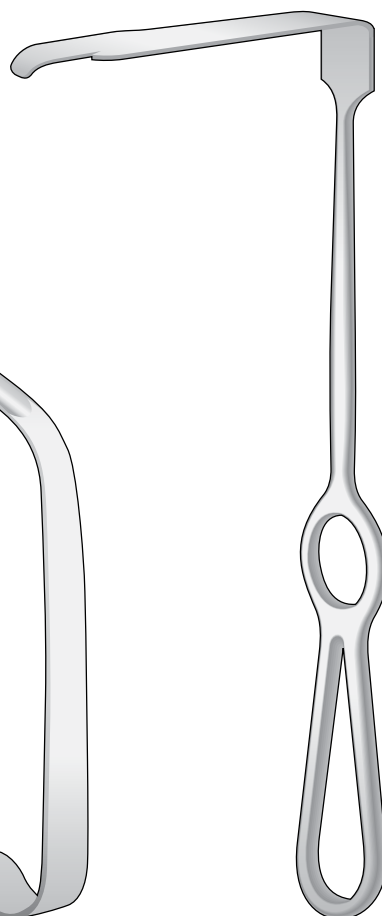

MISCH
BT-158
210 mm



MISCH
BT-159
210 mm

Mouth gags

Mundsperrer
Apribocca
Abrebocas
Écarteur buccal

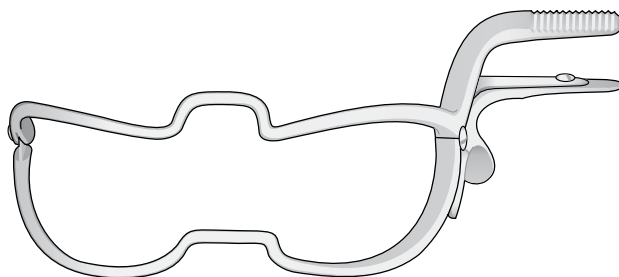

WHITEHEAD-JENNINGS

OM-136 90 mm

OM-137 110 mm

OM-138 130 mm

OM-139 150 mm

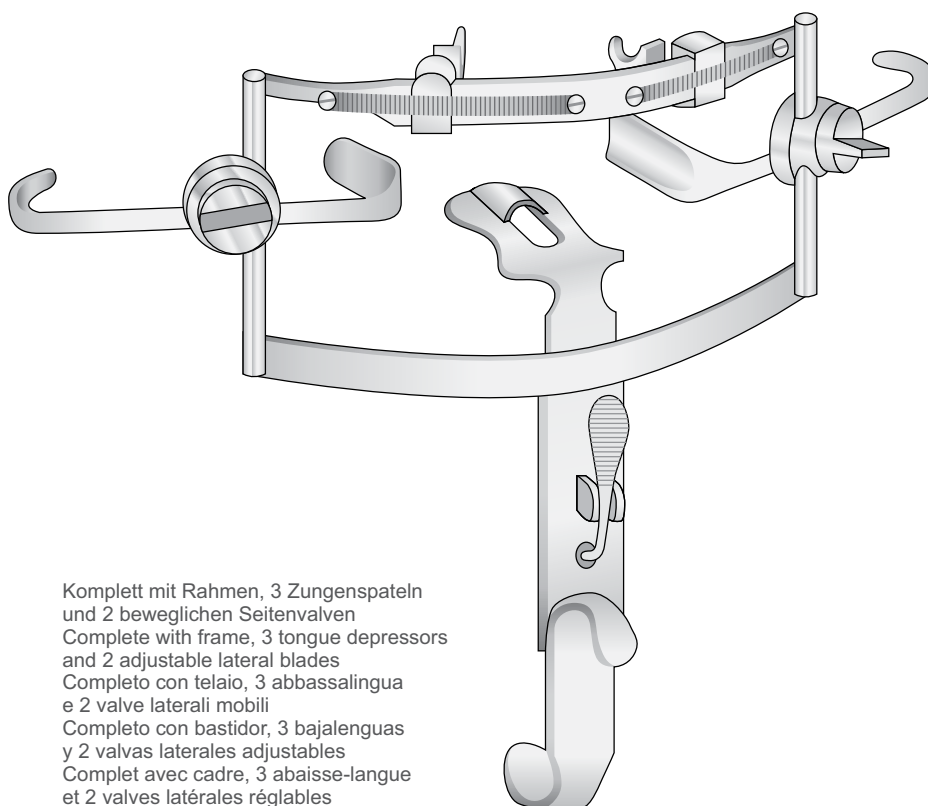

Komplett mit Rahmen, 3 Zungenspateln
und 2 beweglichen Seitenvälven
Complete with frame, 3 tongue depressors
and 2 adjustable lateral blades
Completo con telaio, 3 abbassalingua
e 2 valve laterali mobili
Completo con bastidor, 3 bajalenguas
y 2 valvas laterales ajustables
Complet avec cadre, 3 abaisse-langue
et 2 valves latérales réglables

DINGMANN

OM-110

Set completo

DINGMANN

Zungenspatel
Tongue depressor
Abbassalingua
Bajalengua
Abaisse langue

Fig. 1

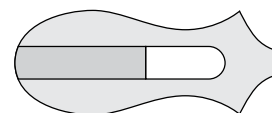

OM-112
65 x 25 mm

Fig. 2

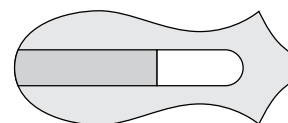

OM-113
70 x 29 mm

Fig. 3

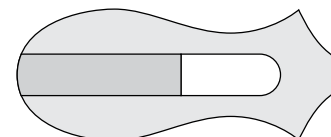

OM-114
80 x 32 mm

Retractors

Wundhaken
Separadores
Ecarteurs
Divaricatori

Retractors

Wundhaken
Separadores
Ecarteurs
Divaricatori

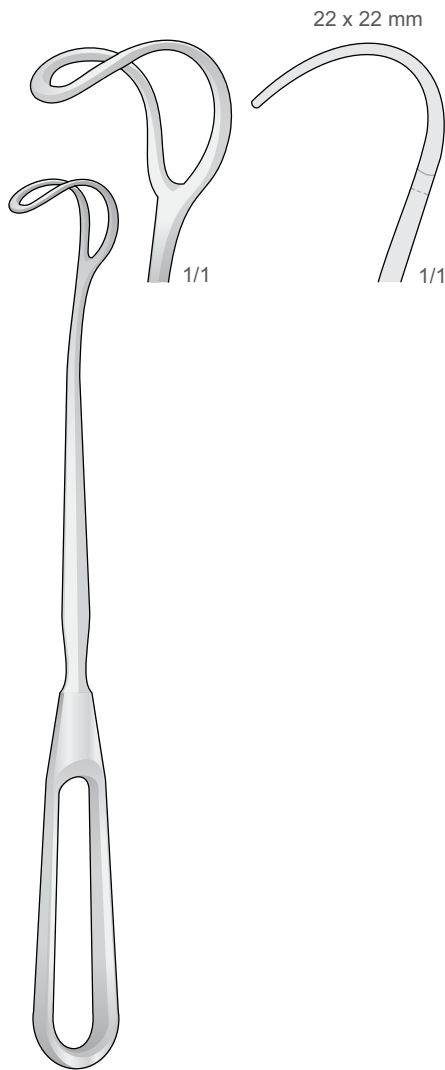

GREENE
BT-131
225 mm

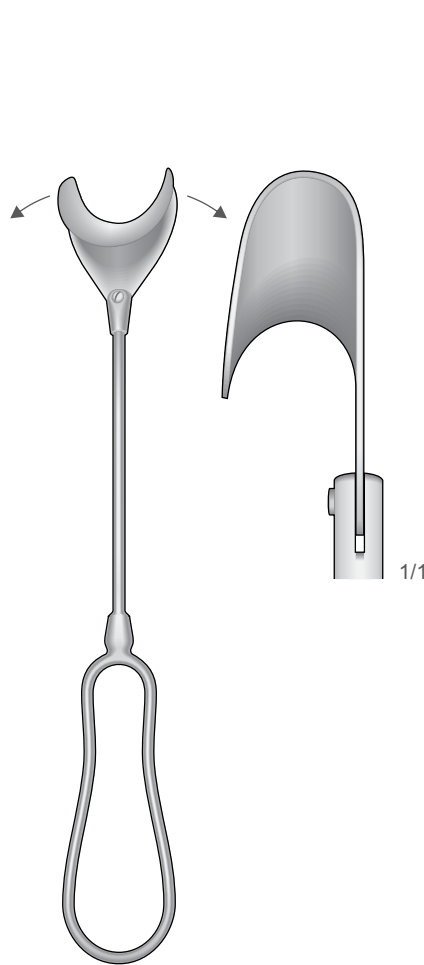

BT-132
200 mm

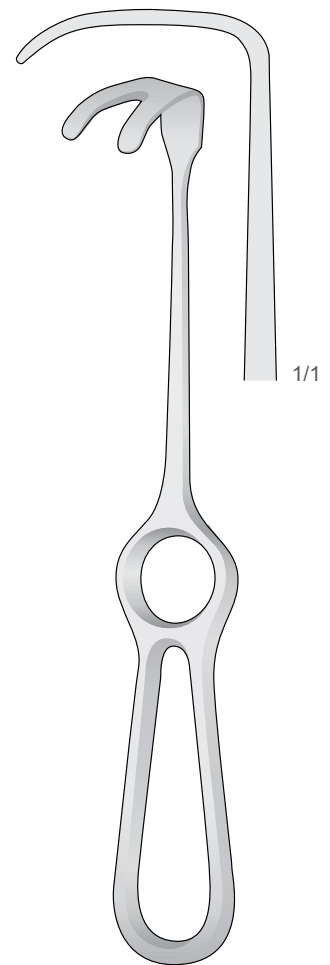

WASSMUND
BT-69
220 mm

Tongue Depressors - Tongue Holding Forceps

Zungenspatel - Zungenzangen
 Abbassalingua - Pinze tiralingua
 Bajalenguas - Pinzas tira-lengua
 Abaisse langues - Pincés tire-langue

16 mm

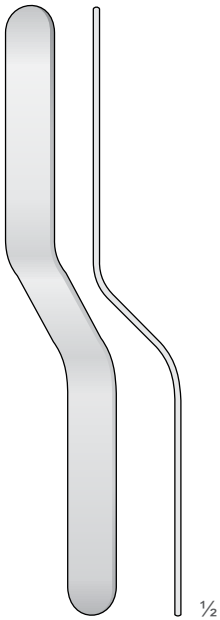

OM-07
 145 mm

19 mm

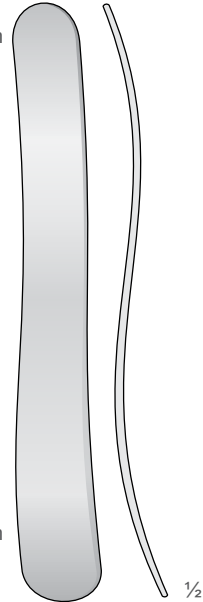

KROENIG OM-16
 150 mm

18 mm

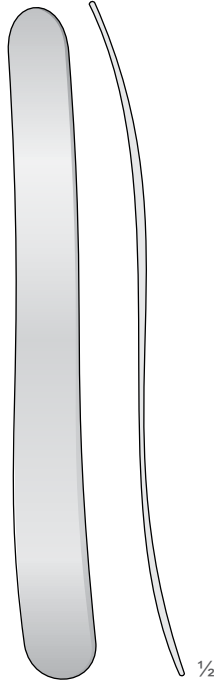

BUCHWALD OM-18
 180 mm

23 mm

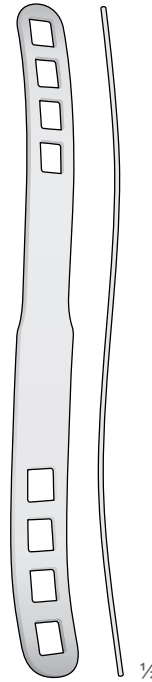

BRUENINGS OM-04
 190 mm

23 mm

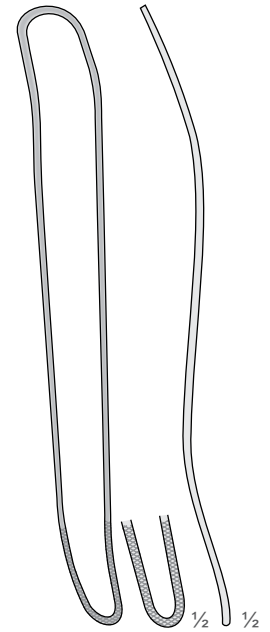

FRENZEL OM-19
 165 mm

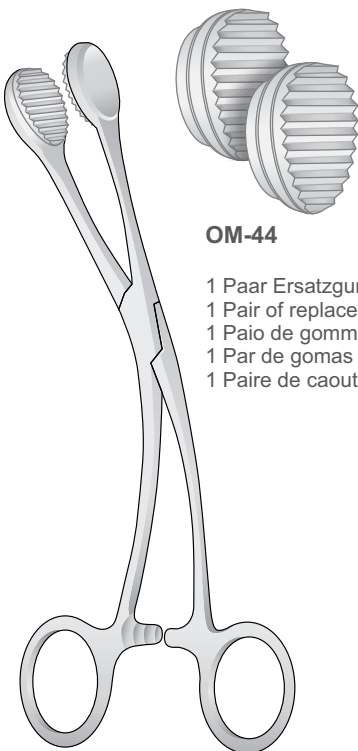

YOUNG OM-45
 160 mm

OM-44

- 1 Paar Ersatzgummi
- 1 Pair of replacement rubber pads
- 1 Paio de gommini di ricambioi
- 1 Par de gomas de recambio
- 1 Paire de caoutchouc de rechange

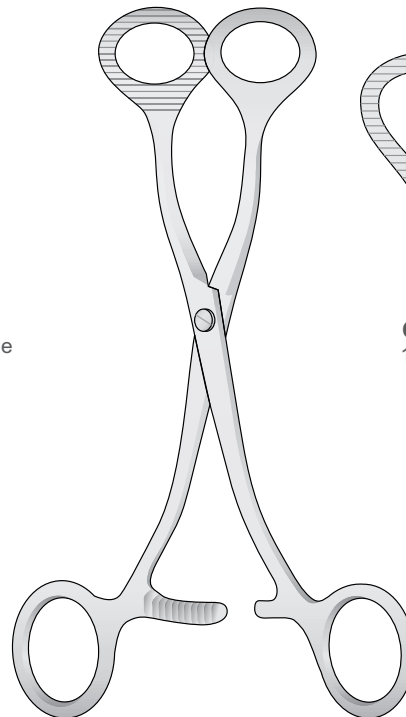

COLLIN OM-10/OM-30

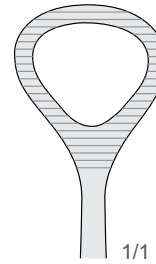

OM-30
 165 mm

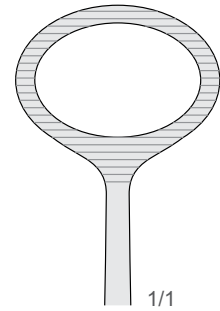

OM-10
 170 mm

Chain and Mouth Props

Kette und Mundstutzen
Catene e Apribocca
Cadena y Abrebocas
Chaîne et Ouvre Bouche

Retractors

Wundhaken
Separadores
Ecarteurs
Divaricatori

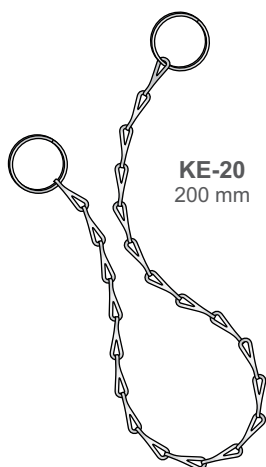

KE-20
200 mm

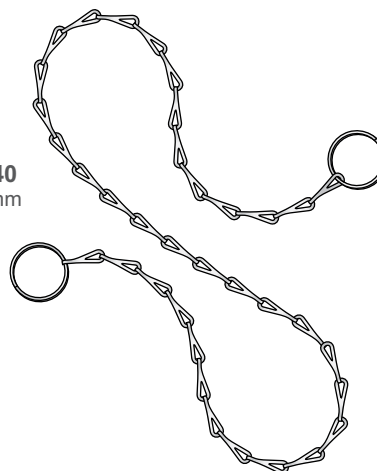

KE-40
400 mm

Dampfsterilisation bis 134°C
Autoclavable to 134°C
Autoclavabile a 134°C
Autoclave hasta 134°C
Autoclavable jusqu'à 134°C

Packung mit 2 Stück
Package with 2 units
Confezione da 2 pezzi
Caja con 2 unidades
Boîte avec 2 pièces

Schwarzer Gummi
Black Rubber
Gomma nera
Caucho negro
Caoutchouc noir



OM-70
SMALL
Klein, für Kinder
Small, for children
Piccolo, per bambini
Pequeño, para niños
Petit, pour enfants



OM-71
MEDIUM
Normal, für Erwachsene
Regular, for adults
Normale, per adulti
Regular, para adultos
Regulier, pour adultes



OM-72
LARGE
Groß, für Erwachsene
Large, for adults
Grande, per adulti
Grande, para adultos
Grand, pour adultes

MSB

IMPLANTOLOGY



Osteotomes

Osteotome
Osteotomi
Osteótomos
Ostéotomes

Implantology

Implantologie
Implantologie
Implantologia
Implantologiya

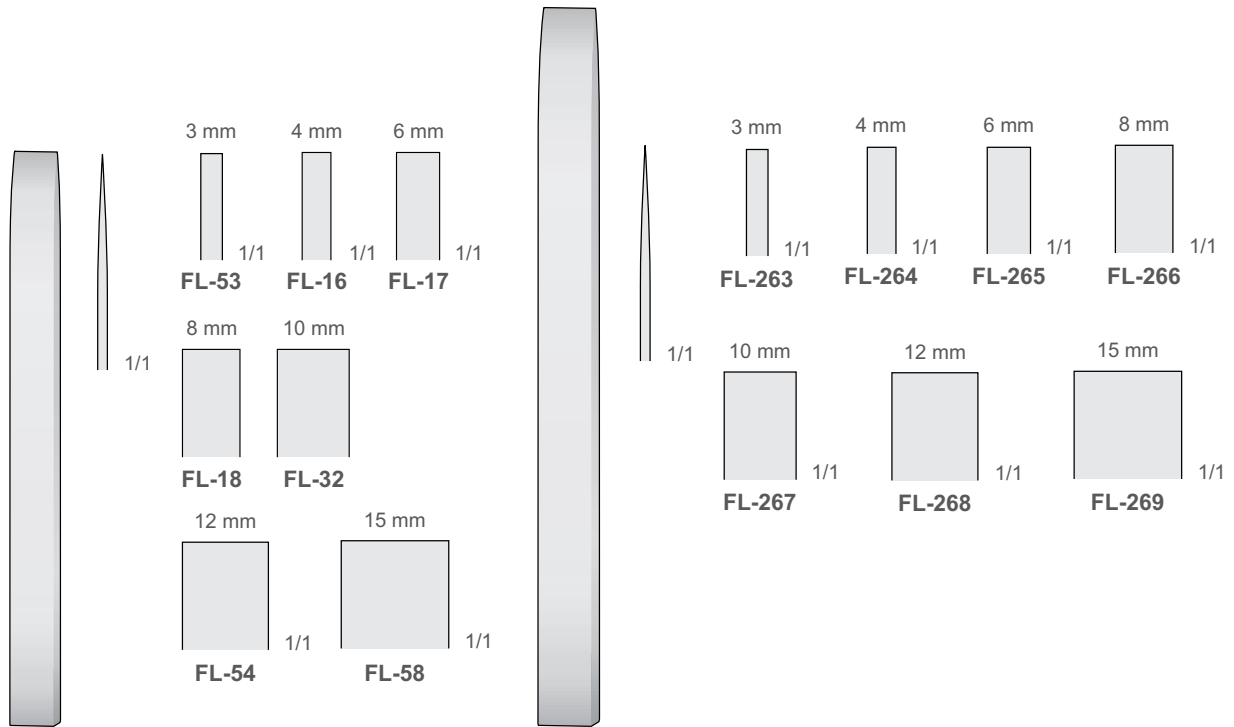

MINI-LAMBOTTE
FL-16/FL-58
125 mm

MINI-LAMBOTTE
FL-263/FL-269
170 mm

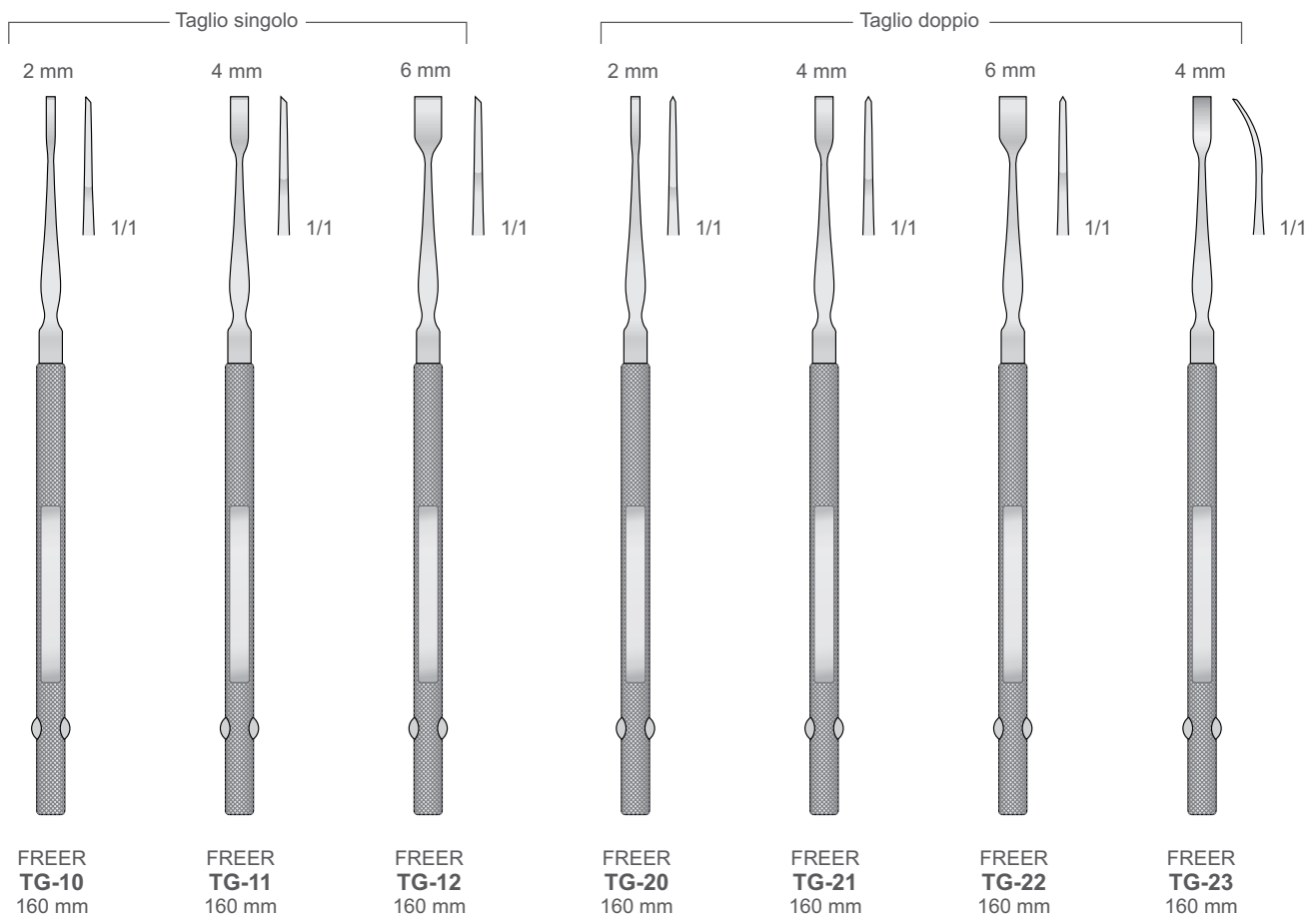

FREER
TG-10
160 mm

FREER
TG-11
160 mm

FREER
TG-12
160 mm

FREER
TG-20
160 mm

FREER
TG-21
160 mm

FREER
TG-22
160 mm

FREER
TG-23
160 mm

Osteotomes - Gouges

Osteotome - Meißel
 Osteotomi - Sgorbie
 Osteótomos - Gubias
 Ostéotomes - Gouges

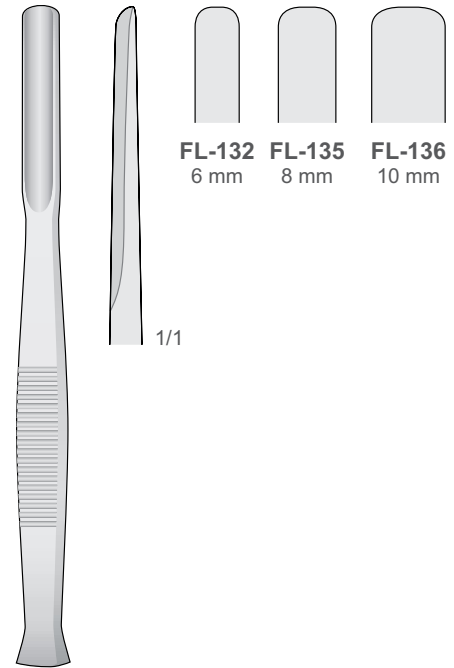
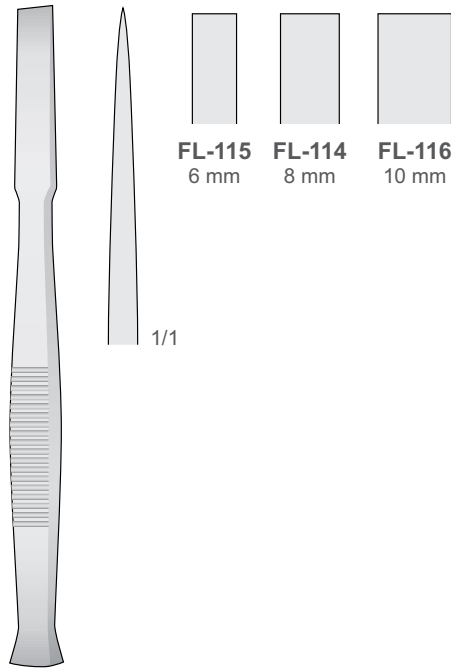

FL-114/FL-116
140 mm

FL-132/FL-136
140 mm

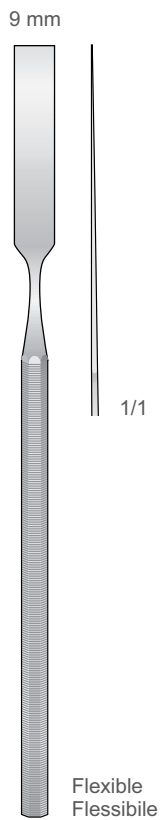

TG-15
170 mm

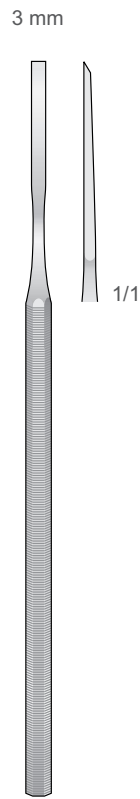

TG-30
155 mm

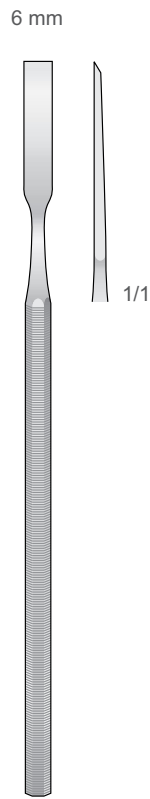

TG-31
155 mm

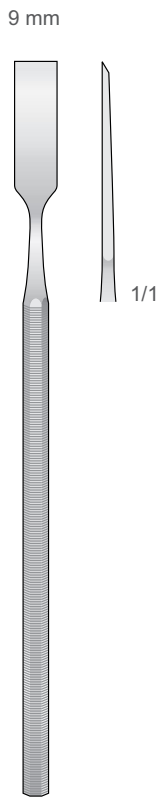

TG-32
155 mm

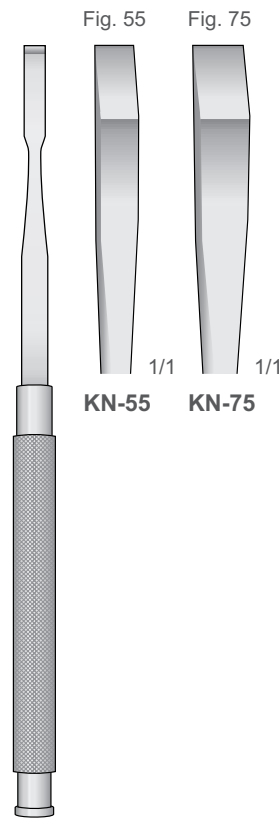

KRAMER-NEVINS
KN-55/KN-75
175 mm

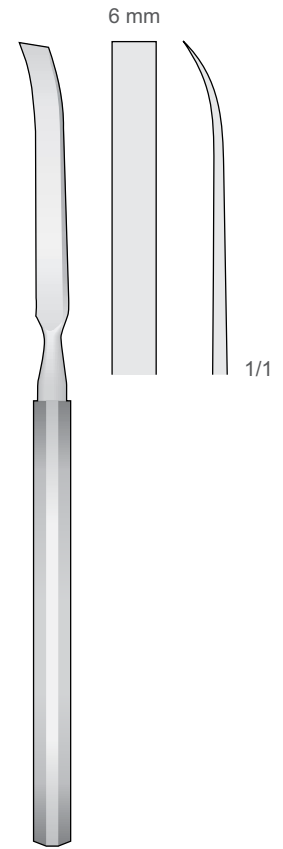

DO-196
180 mm

Osteotomes - Gouges

Osteotome - Meißel
 Osteotomi - Sgorbie
 Osteótomos - Gubias
 Ostéotomes - Gouges

Implantology

Implantologie
 Implantologie
 Implantologia
 Implantologiya

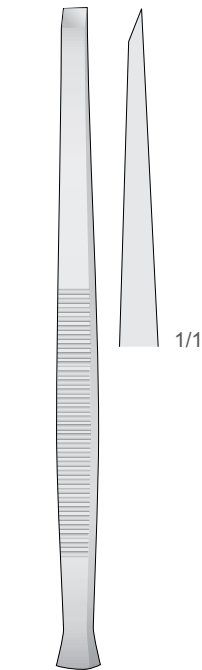

PARTSCH
FL-13/FL-15
 140 mm

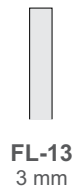

FL-13
 3 mm



FL-14
 4 mm



FL-15
 5 mm

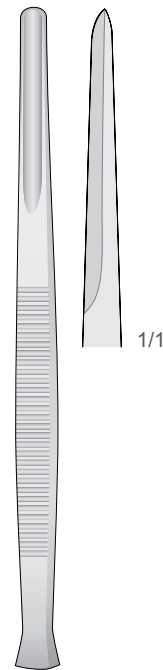

PARTSCH
FL-03/FL-05
 140 mm

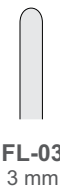

FL-03
 3 mm



FL-04
 4 mm

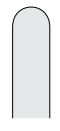

FL-05
 5 mm

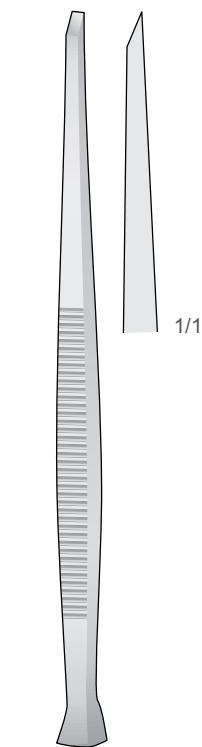

PARTSCH
FL-177/FL-184
 170 mm



FL-177
 3 mm



FL-183
 6 mm



FL-179
 4 mm



FL-184
 7 mm



FL-181
 5 mm

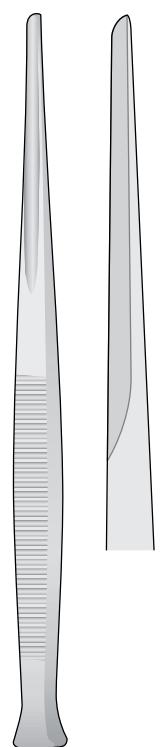

PARTSCH
FL-185/FL-189
 170 mm



FL-185
 3 mm



FL-188
 6 mm



FL-186
 4 mm



FL-189
 7 mm

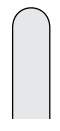

FL-187
 5 mm

Osteotomes - Chisels

Osteotome - Meissel
 Osteotomi - Scalpelli
 Osteótomos - Cinceles
 Ostéotomes - Burins

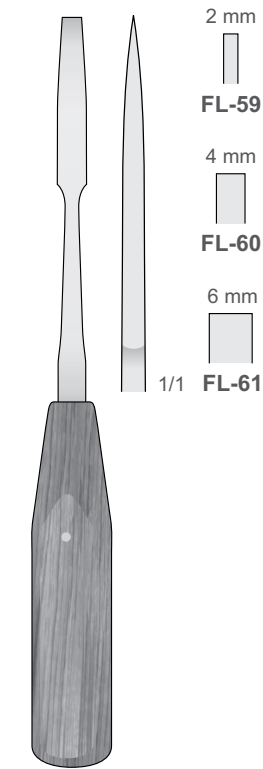

MINI-LEXER
FL-59/FL-61
 200 mm

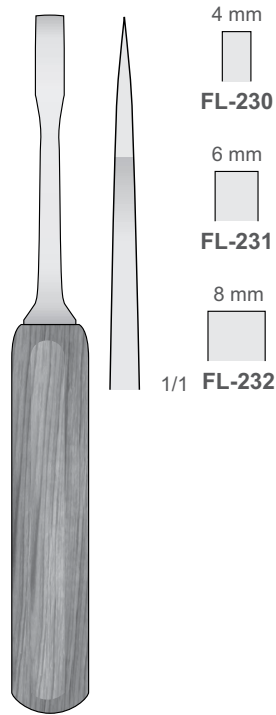

MINI-LEXER
FL-230/FL-232
 180 mm

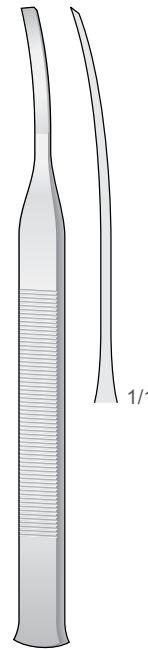

TESSIER
FL-411 5 mm
FL-412 7 mm
 160 mm

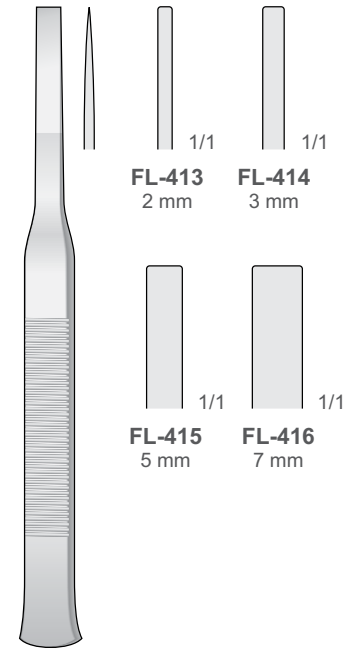

TESSIER
FL-413/FL-416
 160 mm

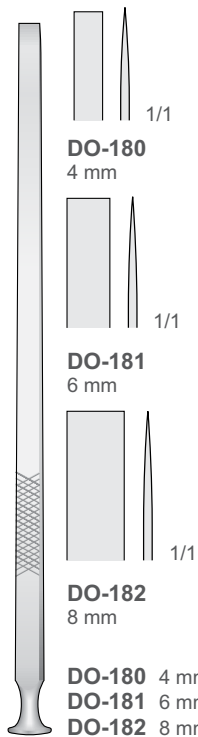

EPKER
DO-180/DO-182
 180 mm

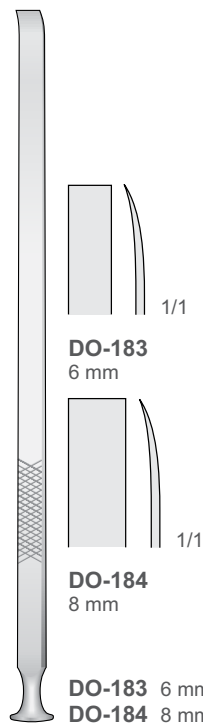

EPKER
DO-183/DO-184
 180 mm

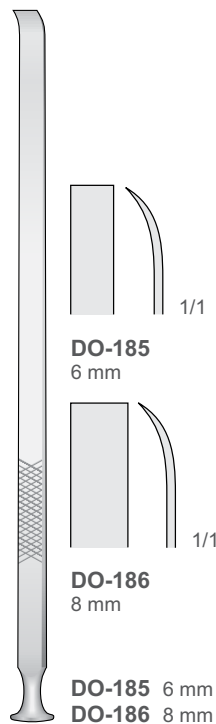

EPKER
DO-185/DO-186
 180 mm

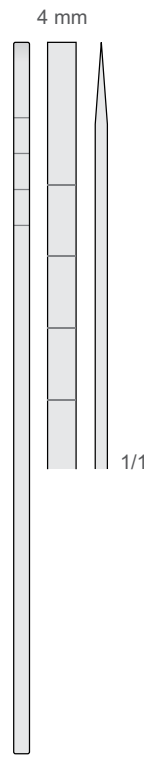

COTTLE
DO-140
 180 mm

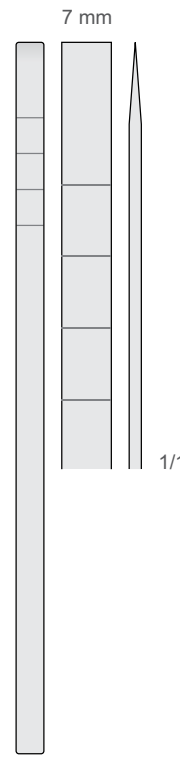

COTTLE
DO-141
 180 mm

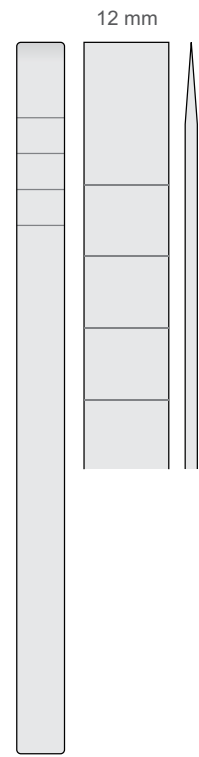

COTTLE
DO-143
 180 mm

Surgical mallets

Chirurgische Hämmer
Martelli chirurgici
Martillos quirúrgicos
Maillets chirurgicaux

Implantology

Implantologie
Implantologie
Implantologia
Implantologiya

Martelli chirurgici
Martillos quirúrgicos
Maillets chirurgicaux

Ø 20 mm - 140 g



FL-01
165 mm

Ø 25 mm - 300 g

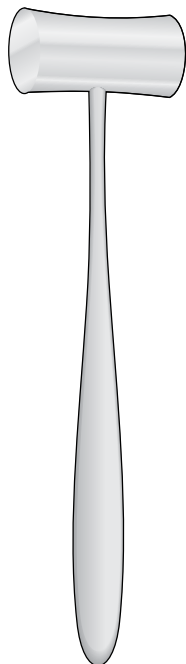

**LUCAE
FL-10M**
190 mm

Ø 27 mm - 135 g

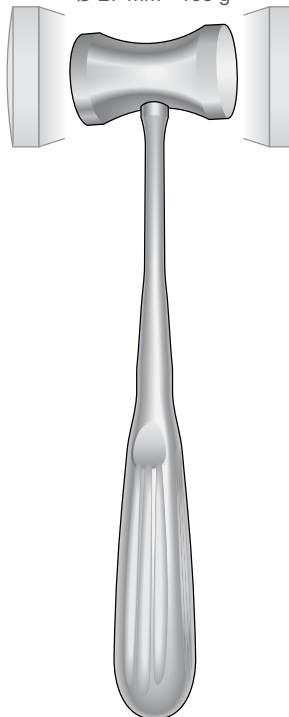

**HAJEK
FL-128**
200 mm

Ø 30 mm - 240 g

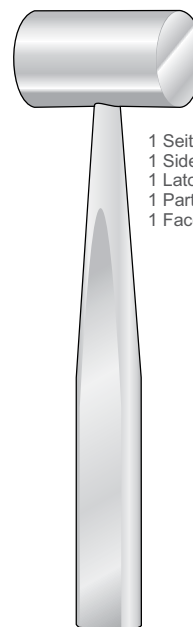

1 Seite flach - 1 Seite convex
1 Side flat - 1 Side convex
1 Lato piatto - 1 Lato convesso
1 Parte plana - 1 Parte convexa
1 Face plate - 1 Face convexe

**COTTLE
FL-104**
185 mm

Ø 20 mm - 160 g

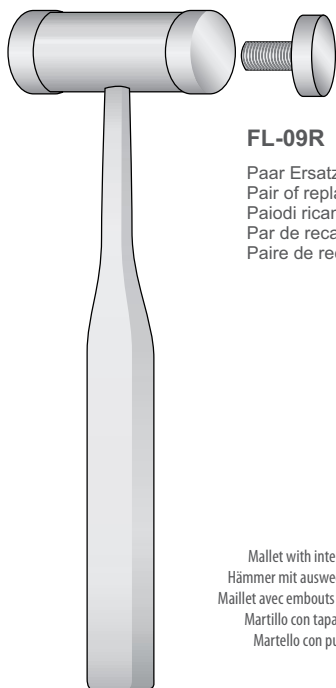

FL-09R

Paar Ersatzbacken
Pair of replacement
Paiodi ricambio
Par de recambio
Paire de rechange

**MEAD
FL-09**
190 mm

Ø 25 mm - 200 g

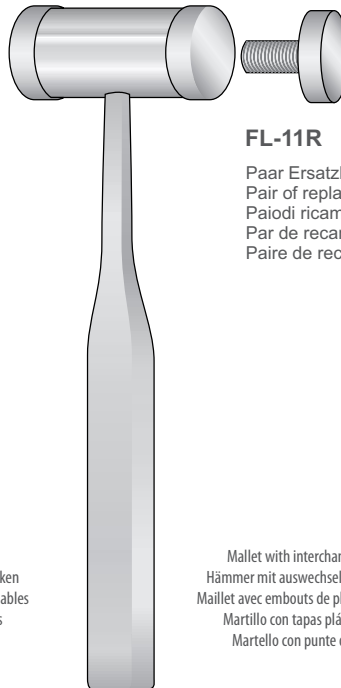

FL-11R

Paar Ersatzbacken
Pair of replacement
Paiodi ricambio
Par de recambio
Paire de rechange

**MEAD
FL-11**
200 mm

Ø 26 mm - 320 g

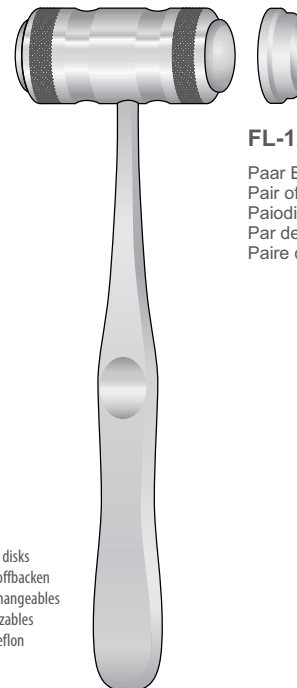

FL-12R

Paar Ersatzbacken
Pair of replacement
Paiodi ricambio
Par de recambio
Paire de rechange

**MEAD
FL-12**
190 mm

Mallet with interchangeable plastic disks
Hämmer mit auswechselbaren Kunststoffbacken
Maillet avec embouts de plastique interchangeables
Martillo con tapas plásticas reemplazables
Martello con punte di ricambi in teflon

Mallet with interchangeable plastic disks
Hämmer mit auswechselbaren Kunststoffbacken
Maillet avec embouts de plastique interchangeables
Martillo con tapas plásticas reemplazables
Martello con punte di ricambi in teflon

Trephines

Trepanbohrer
Trephine
Trépanos
Trépan

Implantology

Implantologie
Implantologie
Implantologia
Implantologiya

Combination Trocar-Trephine Instruments

Bestehend aus einem Trocar, einer gezahnten Trephine und einem Kolben zur Entnahme von Knochentransplantaten aus Tibia und Beckenkamm mittels eines geschlossenen Verfahrens

Consisting of trocar, a toothed trephine and a plunger for taking tibial and iliac bone grafts through a closed technique

Composto di un trequarti, una camicia dentata ed un pistone per il prelievo degli innesti ossei dalla tibia e dalla cresta iliaca tramite una tecnica chirurgica intracutanea

Compuesto por un trócar, un trépano dentado y un émbolo para obtener injertos óseos tibiales e iliacos mediante una técnica cerrada

Composé d'un trocart, d'une tréphine dentée et d'un piston pour le prélèvement de greffes osseuses de la tibia ou de la crête iliaque par une technique fermée

FK-100

Komplettset mit 4 Teilen
Set complete with 4 pieces
Set completo di 4 pezzi
Set completo con 4 piezas
Set complet avec 4 pièces

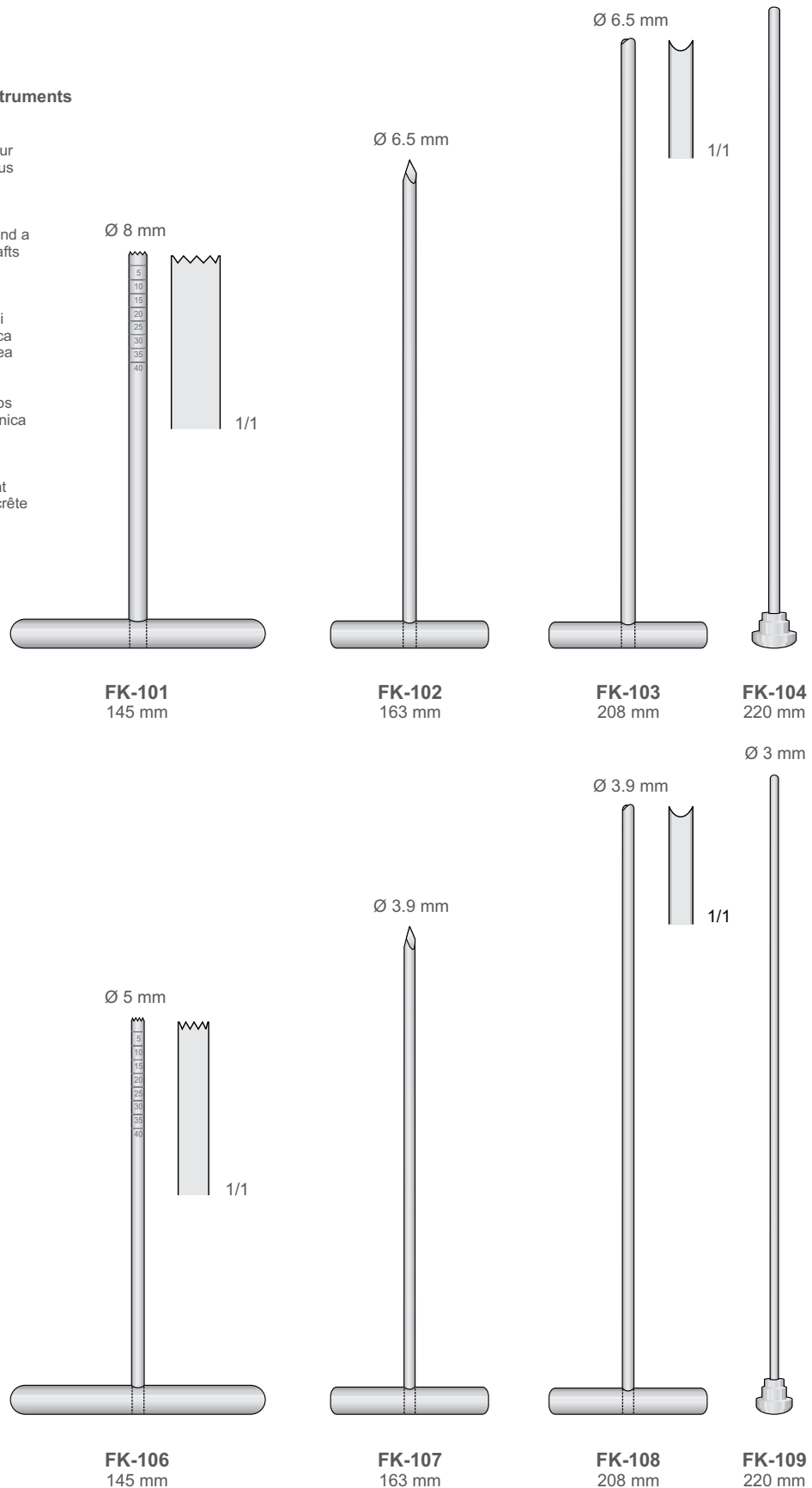

FK-105

Komplettset mit 4 Teilen
Set complete with 4 pieces
Set completo di 4 pezzi
Set completo con 4 piezas
Set complet avec 4 pièces

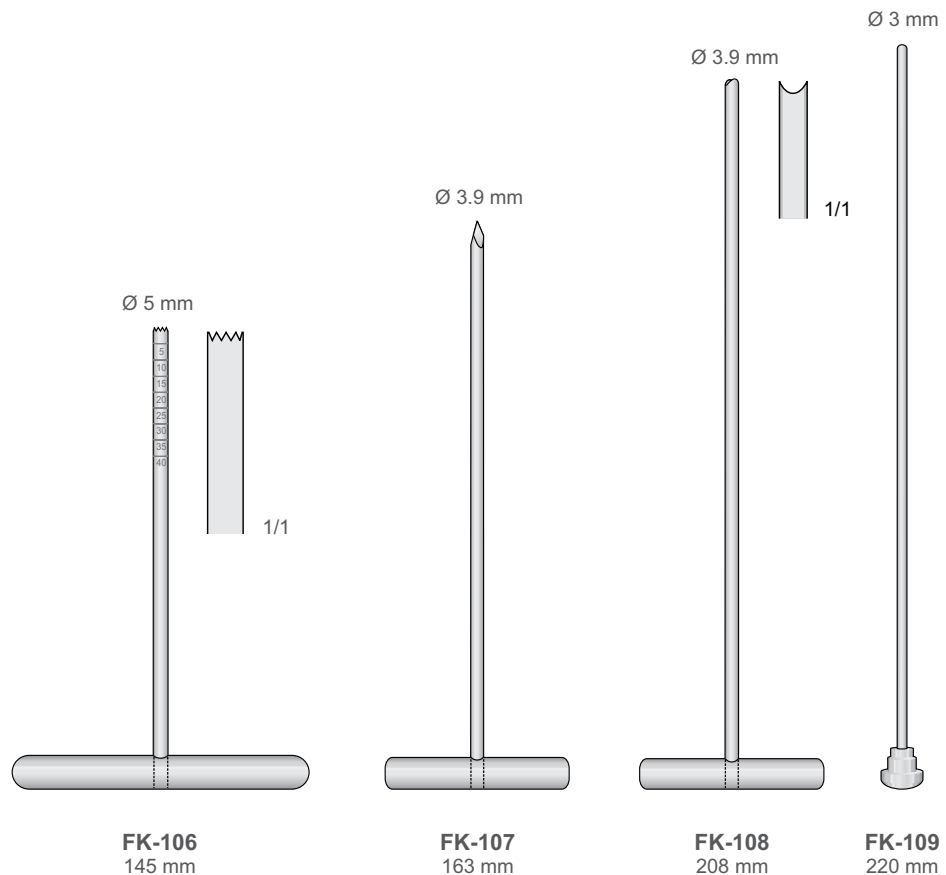

Implantology Instruments

Implantologie Instrumente
Strumenti per implantologia
Instrumentos para Implantología
Instruments pour Implantologie

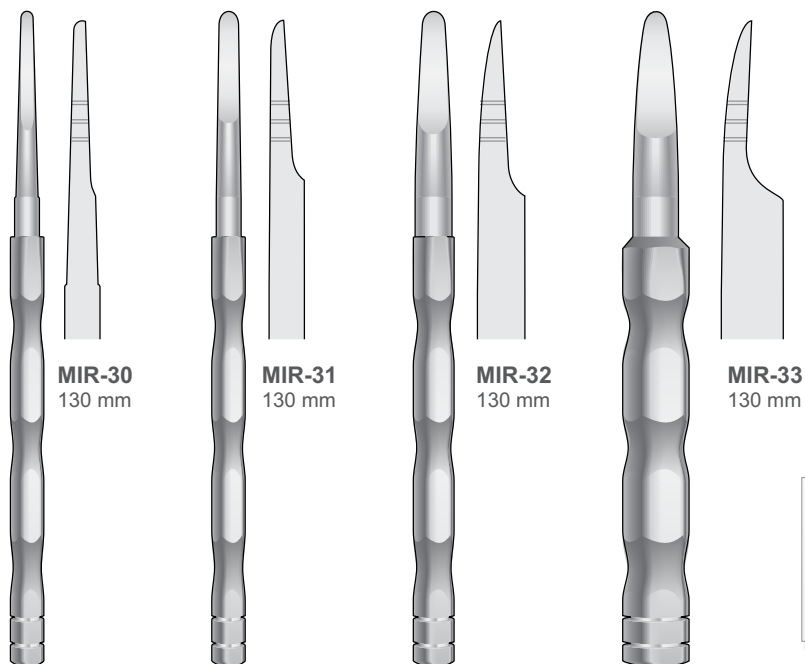

BONE EXPANDERS
Distraktoren für Knochenleiste
Distracteurs de crête osseuse
Expansores de cresta ósea
Distrattori per cresta ossea

TUNNELING INSTRUMENTS

Tunnelierinstrumente | Instruments pour tunnellation | Instrumentos para tunelización | Strumenti per tunneling

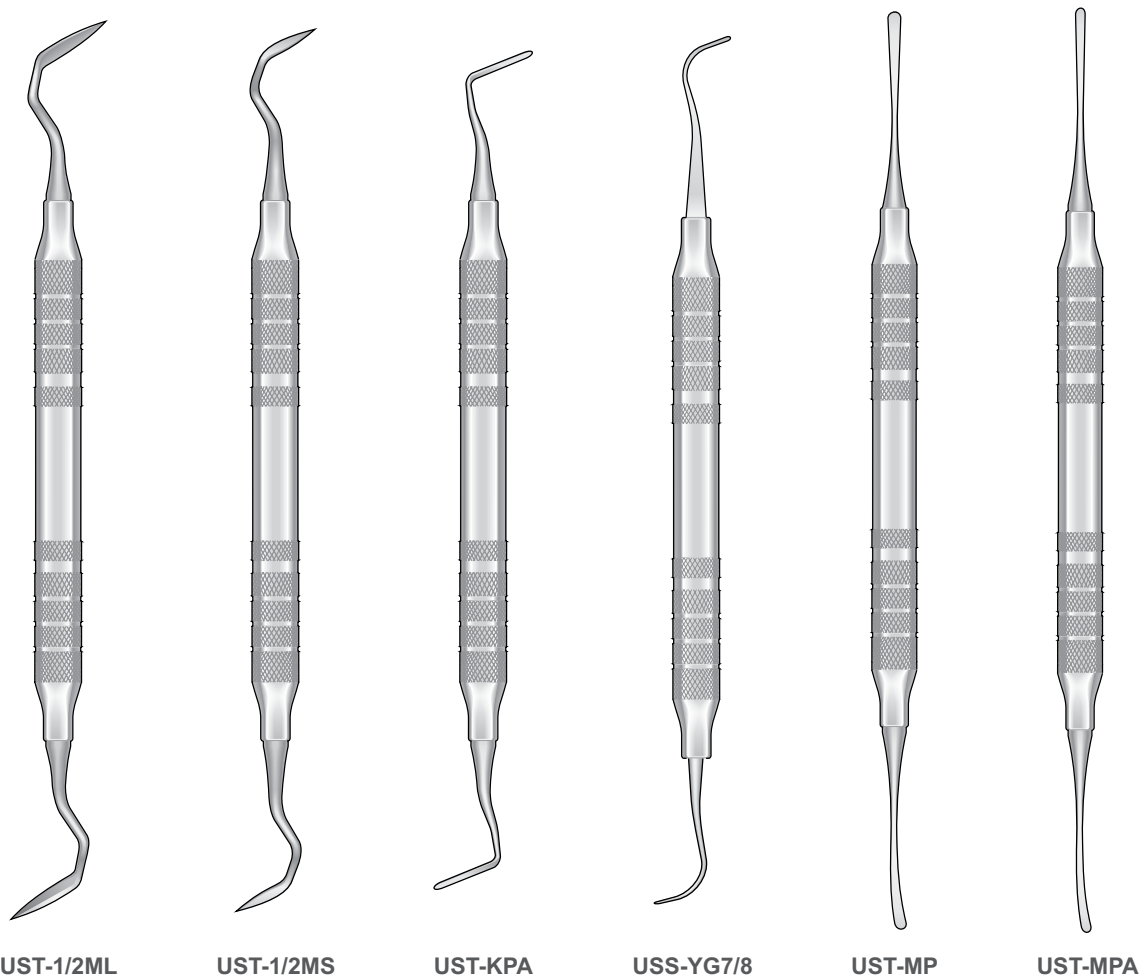

Osteotomes

Osteotome
Osteotomi
Osteótomos
Ostéotomes

Implantology

Implantologie
Implantologie
Implantologia
Implantologiya

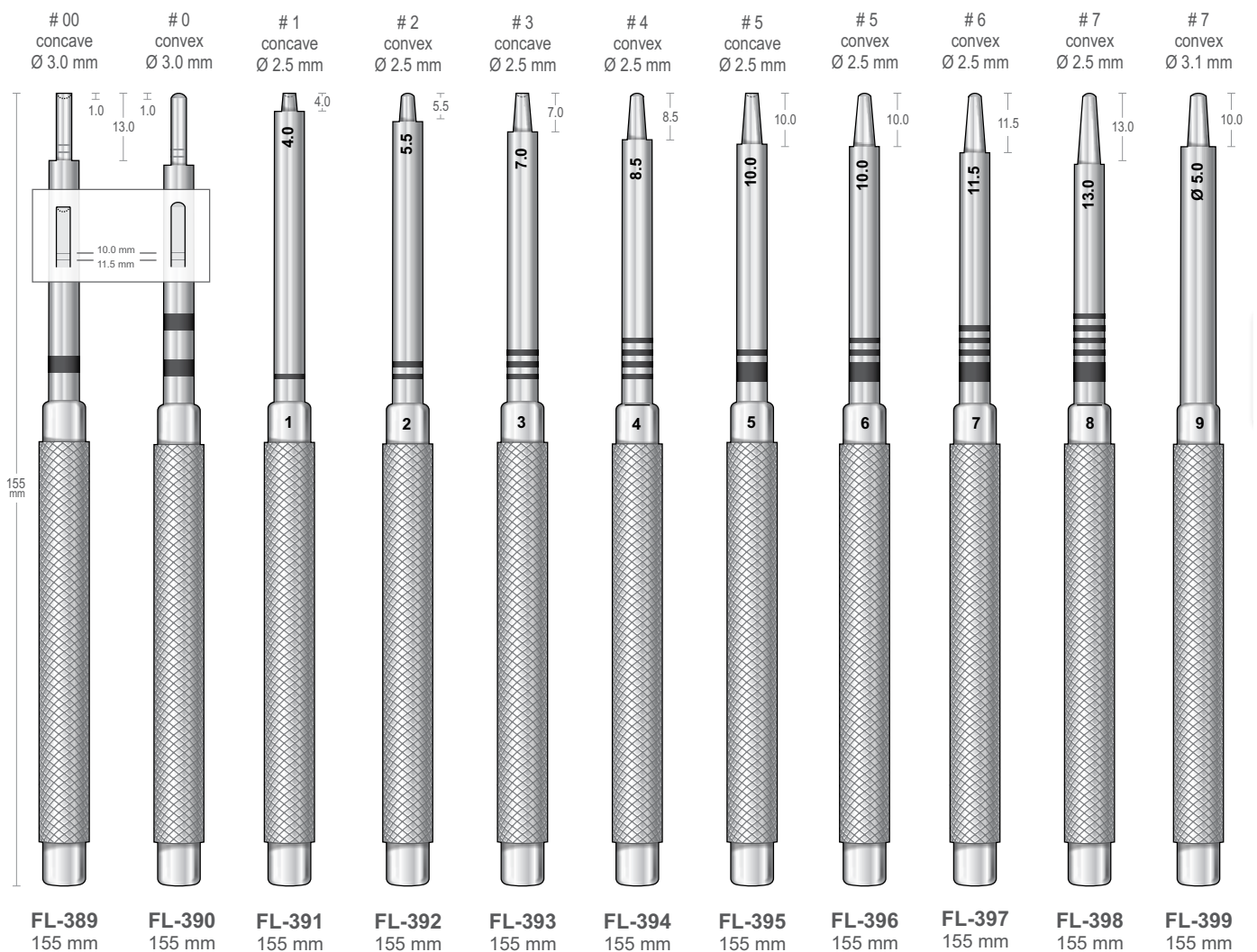

Osteotomes

Osteotome
Osteotomi
Osteótomos
Ostéotomes

# 1	Diam.	# 2	Diam.	# 3	Diam.	# 4	Diam.	# 5	Diam.	# 6	Diam.
0	Ø 1.60	0	Ø 1.90	0	Ø 2.80	0	Ø 3.10	0	Ø 3.90	0	Ø 5.50
7.5	Ø 1.80	7.5	Ø 2.20	7.5	Ø 3.20	7.5	Ø 3.70	10	Ø 5.00	10	Ø 6.20
10	Ø 2.00	10	Ø 2.35	10.5	Ø 3.35	10.5	Ø 3.90	13	Ø 5.20	13	Ø 6.30
13.5	Ø 2.40	13.5	Ø 3.30	13.5	Ø 3.60	15.5	Ø 4.30	20.5	Ø 6.30		
15.5	Ø 3.60	15.5	Ø 3.40	21	Ø 4.40						
		23.5	Ø 4.50								

1
Ø 1.6 mm

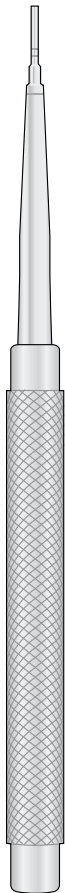

FL-120
155 mm

2
Ø 1.9 mm



FL-121
155 mm

3
Ø 2.8 mm



FL-122
155 mm

4
Ø 3.10 mm



FL-123
155 mm

5
Ø 3.90 mm



FL-124
155 mm

6
Ø 5.50 mm



FL-125
155 mm

Osteotomes

Osteotome
Osteotomi
Osteótomos
Ostéotomes

Implantology

Implantologie
Implantologie
Implantologia
Implantologiya

# 1	Diam.	# 2	Diam.	# 3	Diam.	# 4	Diam.	# 5	Diam.
0	Ø 1.50	0	Ø 2.10	0	Ø 2.60	0	Ø 3.00	0	Ø 3.50
5	Ø 1.90	5	Ø 2.60	5	Ø 3.00	5	Ø 3.50	5	Ø 3.90
8	Ø 2.20	8	Ø 2.80	8	Ø 3.30	8	Ø 3.80	8	Ø 4.20
10	Ø 2.40	10	Ø 3.00	10	Ø 3.50	10	Ø 4.00	10	Ø 4.40
12	Ø 2.60	12	Ø 3.20	12	Ø 3.70	12	Ø 4.20	12	Ø 4.60
14	Ø 2.80	14	Ø 3.40	14	Ø 3.90	14	Ø 4.40	14	Ø 4.80

Straight
Gerade
Droit
Recto
Diritto

Bone Pusher

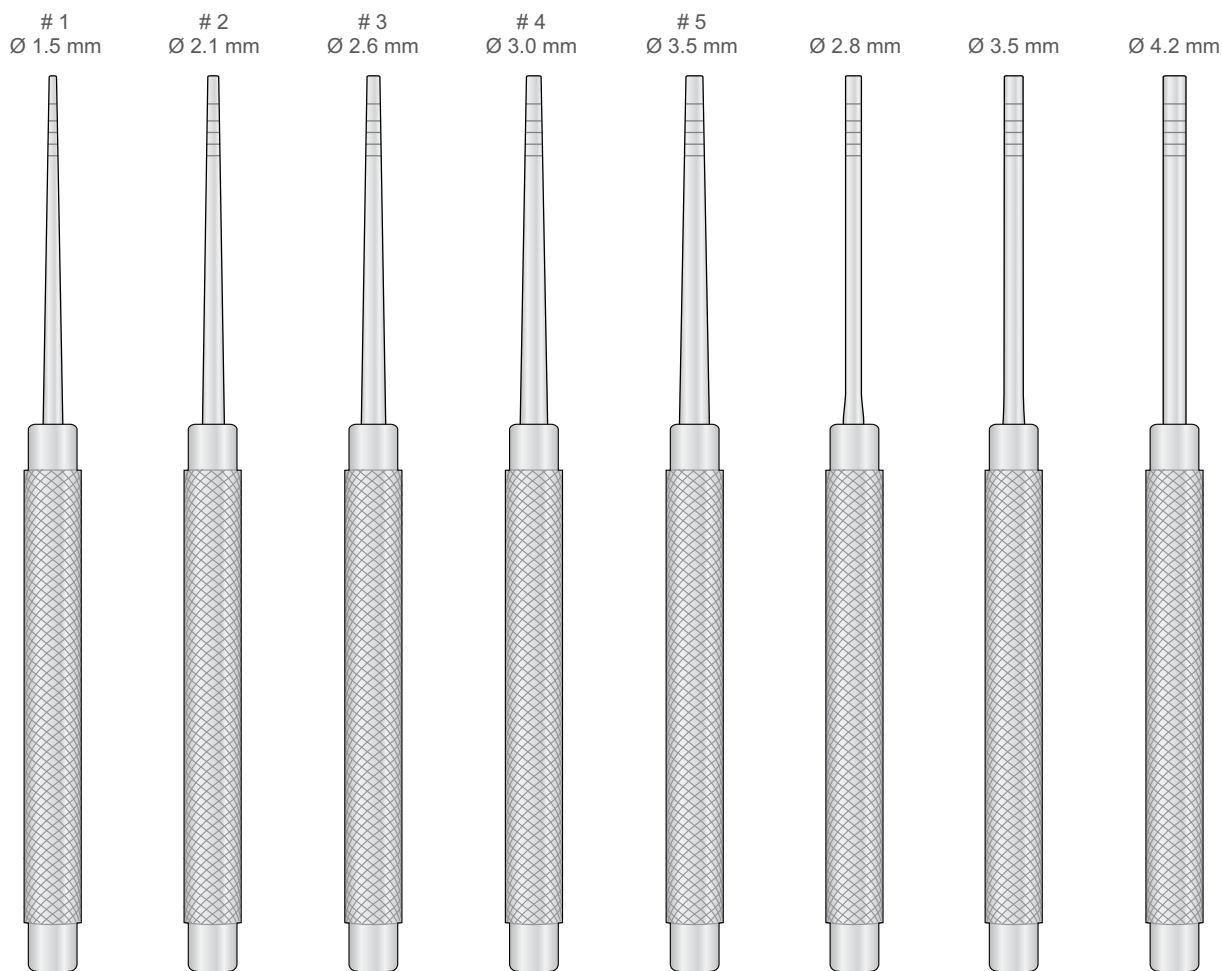

FL-292
55 mm

FL-293
155 mm

FL-294
155 mm

FL-295
155 mm

FL-296
155 mm

FL-297
155 mm

FL-298
155 mm

FL-299
155 mm

Osteotomes

Osteotome
Osteotomi
Osteótomos
Ostéotomes

Meißeln Graduiert
Graduated Chisels
Scalpelli graduati
Cinceles graduados
Burins gradués

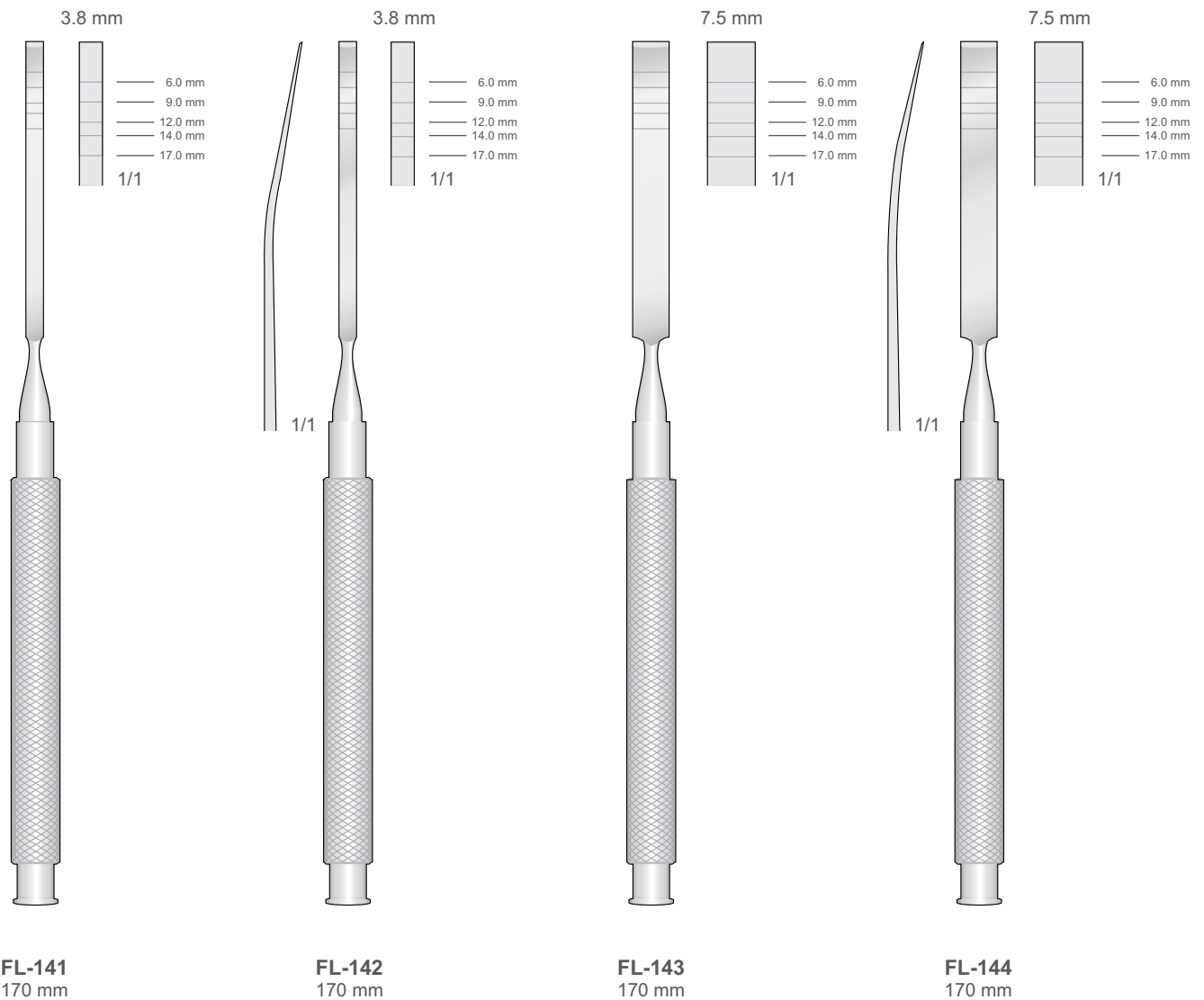

Osteotomes

Osteotome
Osteotomi
Osteótomos
Ostéotomes

Implantology

Implantologie
Implantologie
Implantologia
Implantologiya

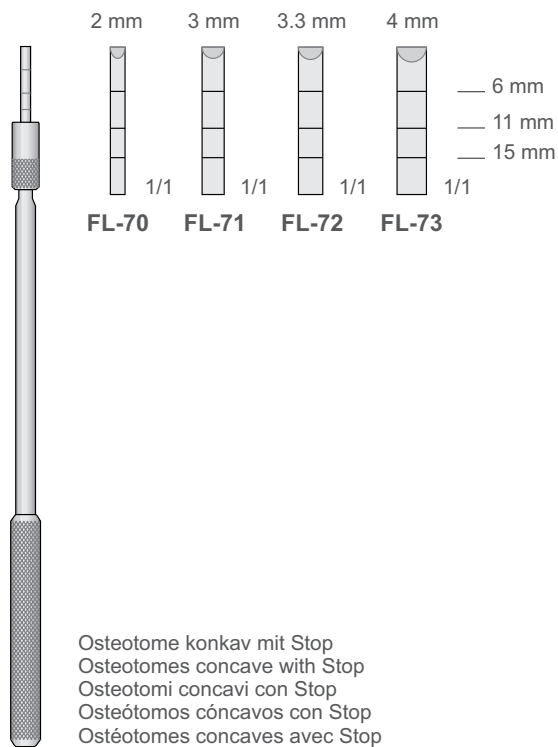

FL-70/FL-73
165 mm

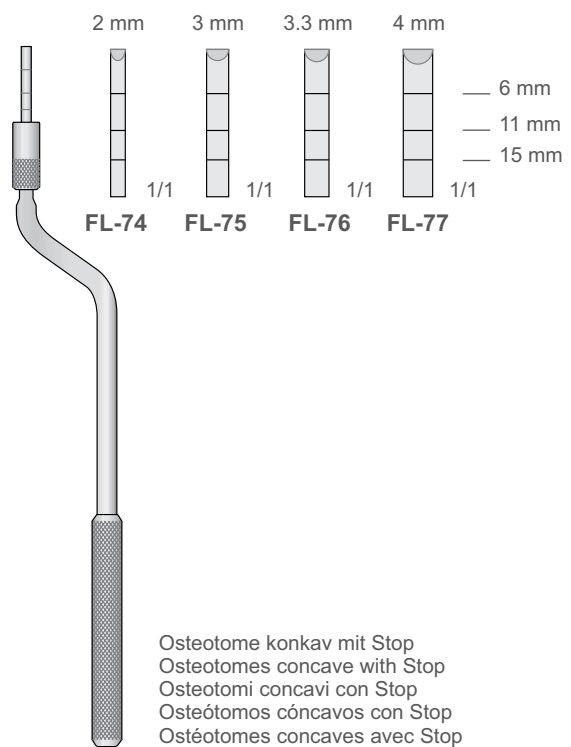

FL-74/FL-77
165 mm

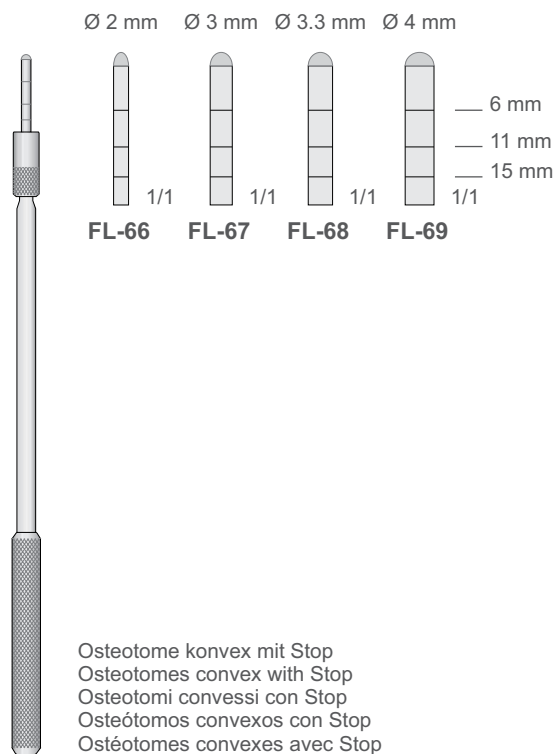

FL-66/FL-69
165 mm

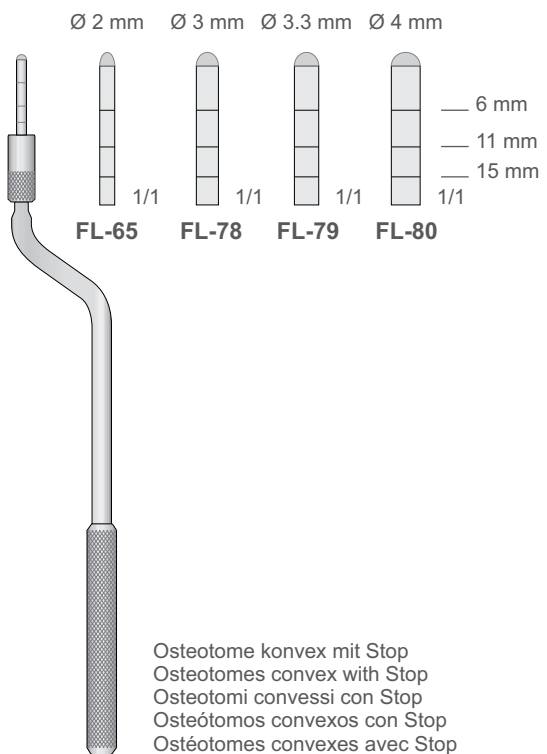

FL-65/FL-80
160 mm

Osteotomes

Osteotome
Osteotomi
Osteótomos
Ostéotomes

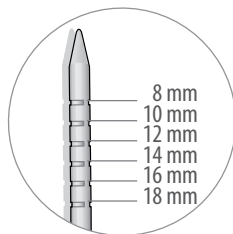

Dilatator
Dilator
Dilatatori
Dilatador
Dilateur

A-Form

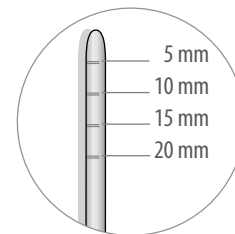

Spreader
Spreader
Expansori
Expansor
Expandeur

**D-Form
Convex Tip**

Ø 2 mm

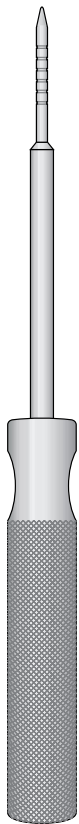

FL-25
145 mm

Ø 3 mm



FL-26
145 mm

Ø 3.3 mm

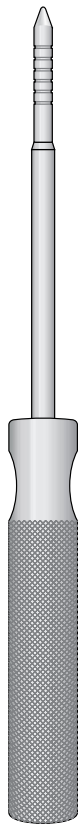

FL-27
145 mm

Ø 4 mm



FL-28
145 mm

Ø 3 mm



FL-37
145 mm

Ø 4 mm



FL-38
145 mm

Ø 5 mm



FL-39
145 mm

Trephines

Trepanbohrer
Trepine
Trépanos
Trépan

Implantology

Implantologie
Implantologie
Implantologia
Implantologiya

For Tissue
Für Gewebe
Pour tissu
Para tejido
Per tessuto

Nicht Gezahnt
Non Serrated
No dentellato
No dentado
Non dentelé

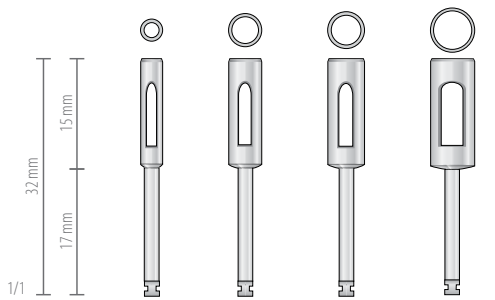

Ø mm	GA-63	GA-64	GA-65	GA-66
Int.	2.5	4.0	4.5	5.5
Ext.	3.0	4.5	5.0	6.0

For Bone
Für Knochen
Pour os
Para hueso
Per osso

Gezahnt
Serrated
Dentellato
Dentado
Dentelé

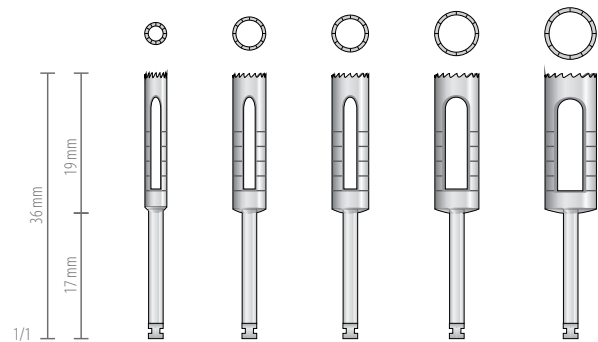

Ø mm	GA-33	GA-34	GA-35	GA-36	GA-37
Int.	2.5	4.0	4.5	5.5	6.5
Ext.	3.0	4.5	5.0	6.0	7.0

Hautstanzen
Tissue Punches
Mucotomi Punches
Bisturí circular para tejido
Bistouri circulaire pour tissue

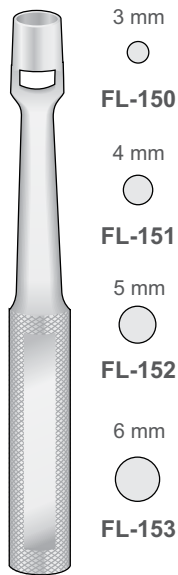

KEYES
FL-150/FL-153
100 mm

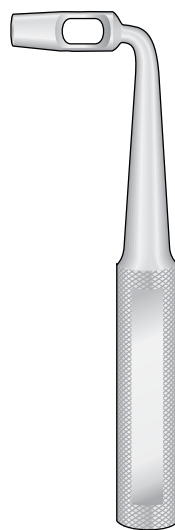

KEYES
FL-155/FL-159
90 mm

Implant Graduierung
Implant depth gauge with ball end
Sonda per controllare la profondità del sito
Sonda para controlar la profundidad

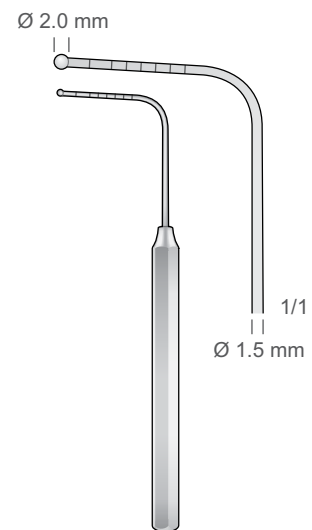

GA-60
100 mm

Implantology Instruments

Implantologie Instrumente
Strumenti per implantologia
Instrumentos para Implantología
Instruments pour Implantologie



**PELTON-CRANE
TS-40**
Connection Piece
int. Ø 7.5 mm
ext. Ø 10.0 mm
75 mm

inox Stainless Steel

Schalen
Bowl
Ciotola
Cuenco
Bacinella

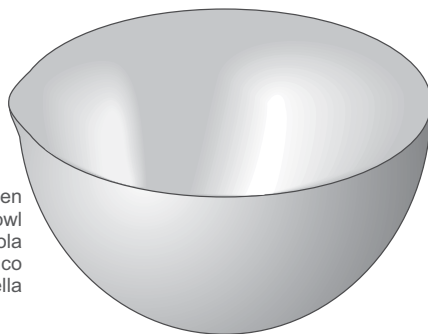

CS-01 Ø 40 mm, 15 cc - 0.5 oz
CS-02 Ø 60 mm, 75 cc - 2.5 oz
CS-03 Ø 80 mm, 225 cc - 7.5 oz
CS-04 Ø 100 mm, 325 cc - 11 oz
CS-05 Ø 120 mm, 500 cc - 17 oz
CS-06 Ø 150 mm, 600 cc - 20 oz



Knochenschale
Bone Well
Bacinella per osso
Cubeta para hueso
Cuvette à os

Amalgambecher
Amalgam Well
Mortajo per amalgama
Recipiente para amalgama
Gobelet pour amalgame

SS-65
Ø 35x35 mm
depht 15 mm
5cc - 0.17oz

Absaugkanülen für Knochen mit Filter
Suction tube for bone with filter
Cannule d'aspiration con trattenuta osso con filtro
Cánulas aspiradoras para hueso con filtro
Canule d'aspiration pour os avec filtre

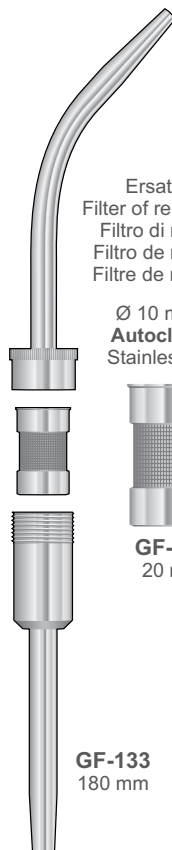

Ersatzfilter
Filter of replacement
Filtro di ricambio
Filtro de recambio
Filtre de rechange

Ø 10 mm int.
Autoclavable
Stainless Steel

GF-134
20 mm

GF-133
180 mm

Membranplatzierungsinstrumente
Membrane Placement Instruments
Strumenti per posizionare membrana
Instrumentos para colocar membranas
Instruments pour application de membrane

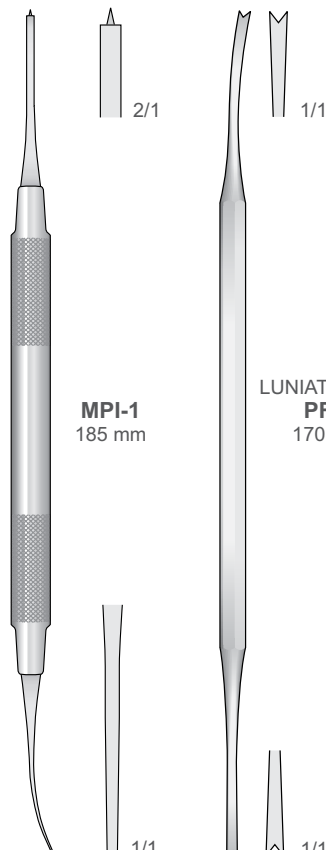

MPI-1
185 mm

**LUNIATSCHEK
PF-6**
170 mm

Aufbring Instrument für Knochenmaterial
Applicator for bone material
Aplicatore per materiale osseo
Cucharillas para material osseo
Applicateur pour matière osseuse

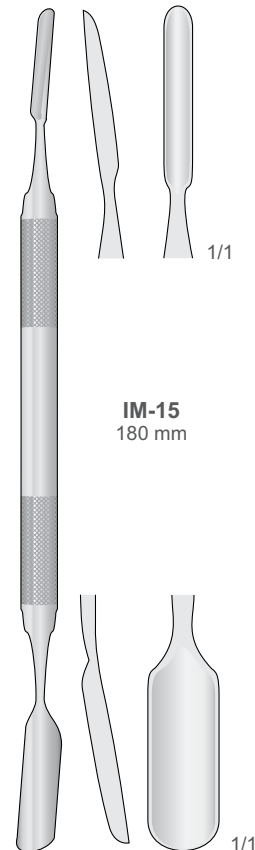

IM-15
180 mm

Bone Mills and Syringes

Knochenmühlen - und spritzen
Macina e siringhe per osso
Molinos y jeringas para hueso
Moulins et seringues à os

Implantology

Implantologie
Implantologie
Implantologia
Implantologiya

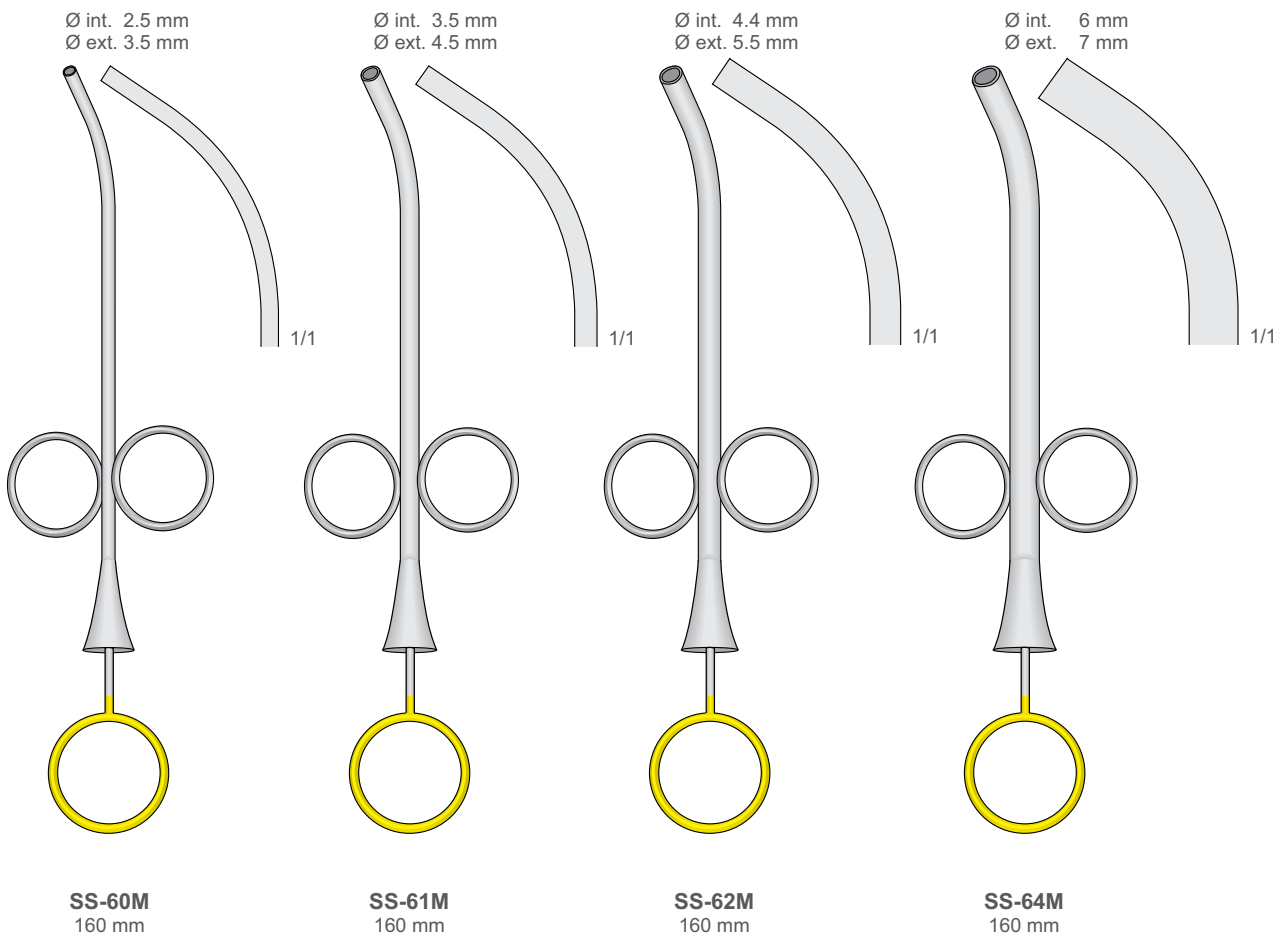
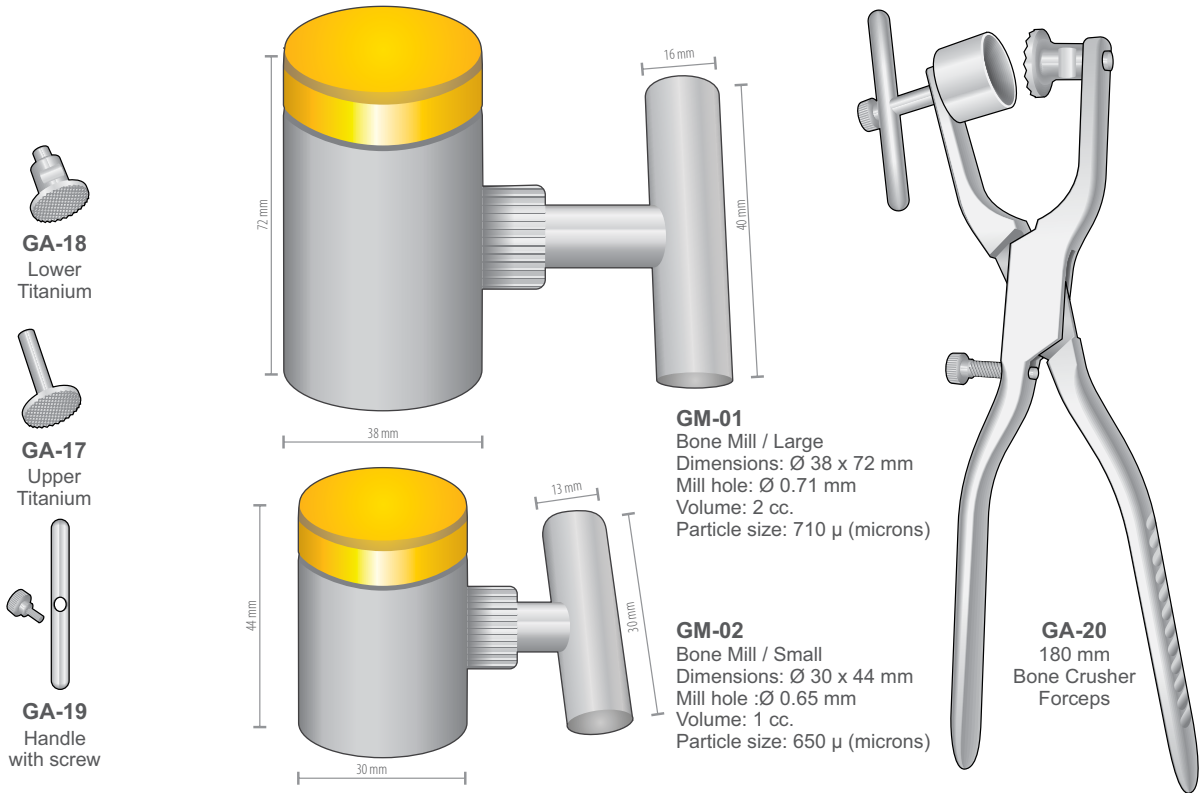

Bone Tampers - Bone Grafting Packers

Knochenstopfer
 Compattatore per osso
 Compactador para hueso
 Compacteur à os

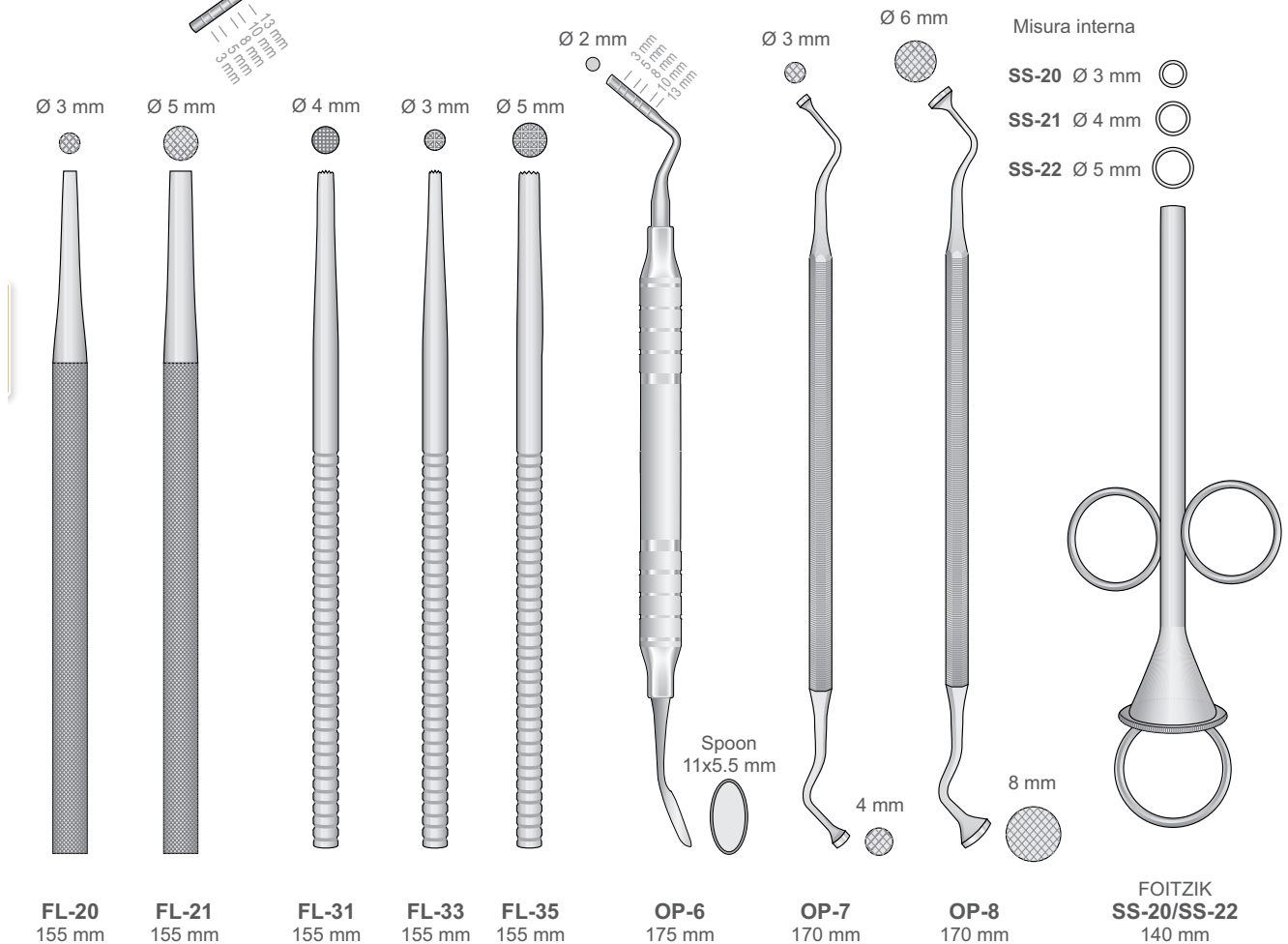
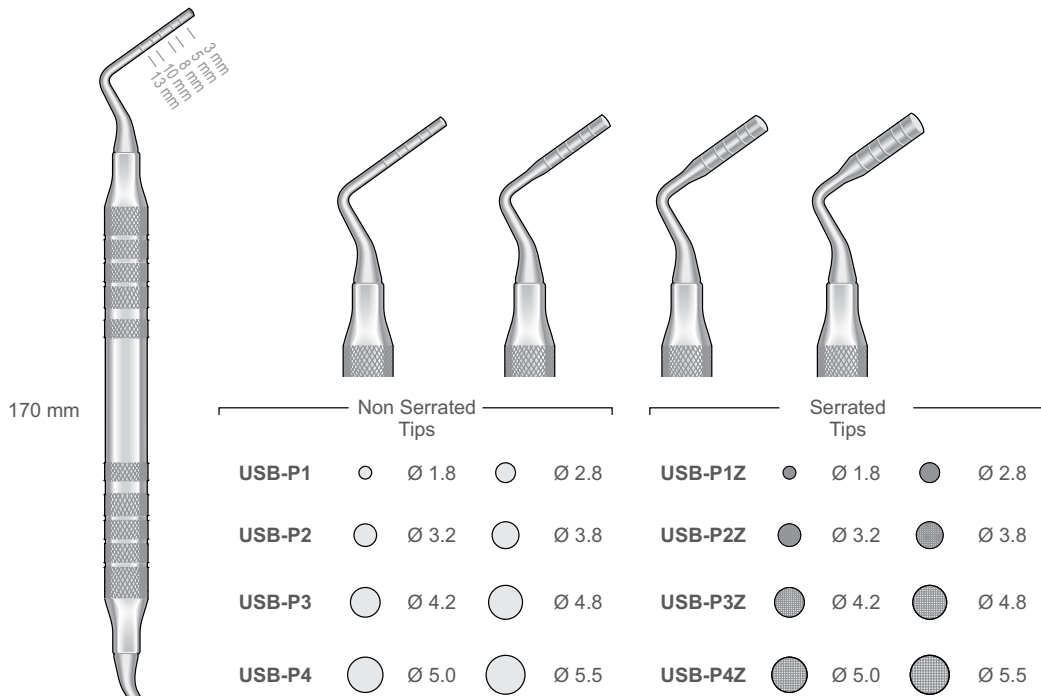

Bone-Grafter. Stainless Steel

Knochenschaber. Rostfrei Stahl
 Grattini per osso. Inox
 Raspador de hueso. Acero inoxidable
 Racleur d'os. Acier inoxydable

Implantology

Implantologie
 Implantologie
 Implantologia
 Implantologiya

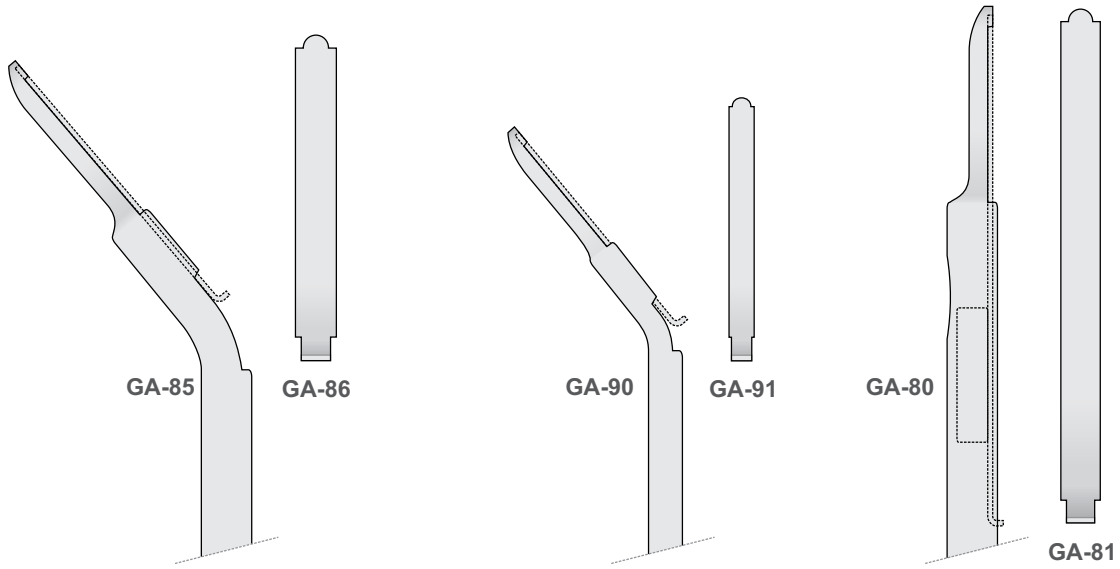

Knochenschaber mit Reibeklinge
 Bone-Grafter with blade
 Grattino con lama
 Raspador de hueso con hoja
 Racleur d'os avec lame

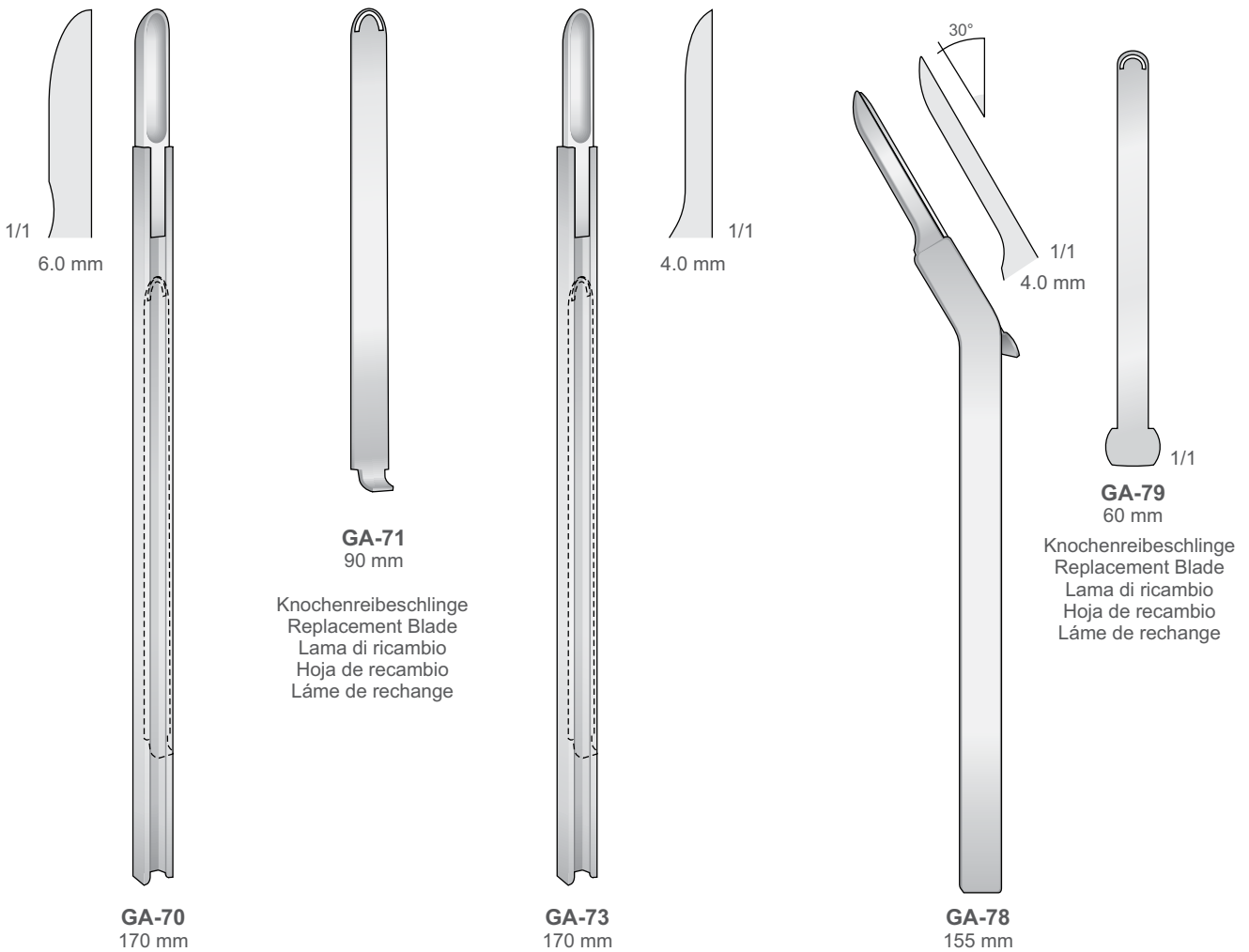

Measuring instruments

Messinstrumente
Strumenti per misura
Instrumentos para medir
Instruments à mesurer



LS-09
200 mm



LS-08
100 mm

Meßbereich: 0 - 20 mm
Measuring range: 0 - 20 mm
Campo di misura: 0 - 20 mm
Alcance de medición: 0 - 20 mm
Etendue de mesure: 0 - 20 mm

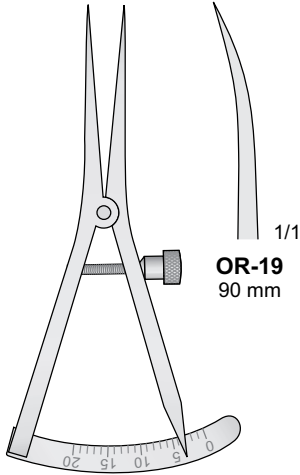

OR-19
CASTROVIEJO
90 mm

Meßbereich: 0 - 80 mm
Measuring range: 0 - 80 mm
Campo di misura: 0 - 80 mm
Alcance de medición: 0 - 80 mm
Etendue de mesure: 0 - 80 mm



OR-40
125 mm

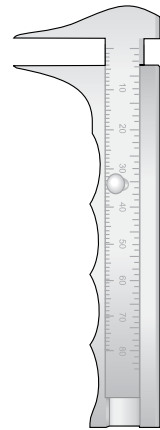

OR-45
95 mm

0 - 40 mm
Meßbereich / Measuring range / Campo di misura
Alcance de medición / Etendue de mesure

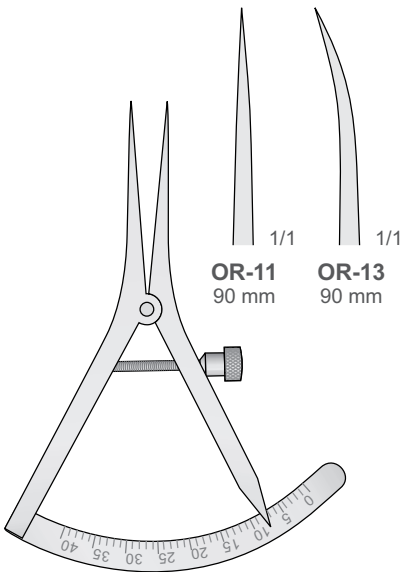

CASTROVIEJO
OR-11/OR-13
90 mm

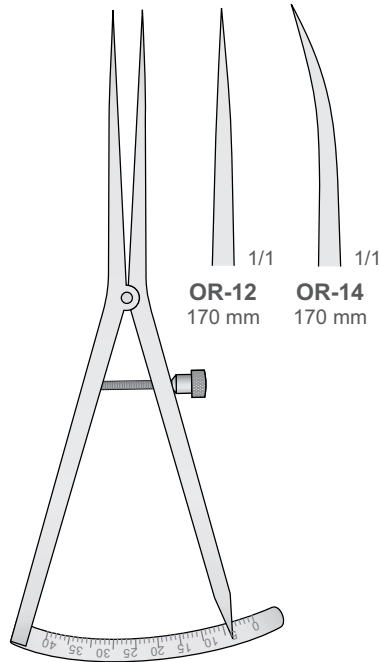

CASTROVIEJO
OR-12/OR-14
170 mm

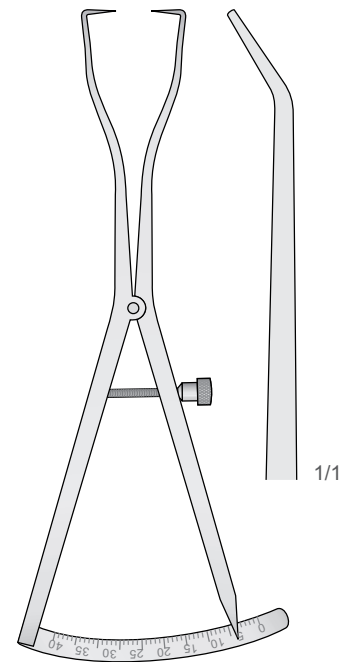

CASTROVIEJO
OR-18
170 mm

Osteometer

Osteometer
Osteometro
Osteometro
Osteometer

Implantology

Implantologie
Implantologie
Implantologia
Implantologia

TRIDIMENSIONAL IMPLANTOLOGY CALIPER

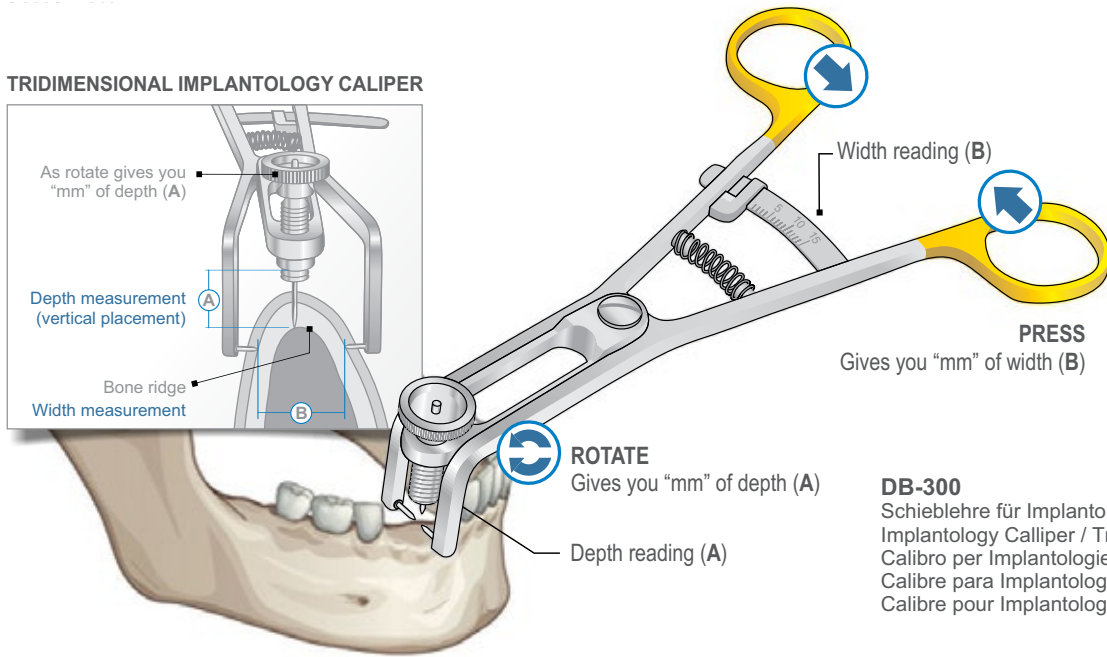
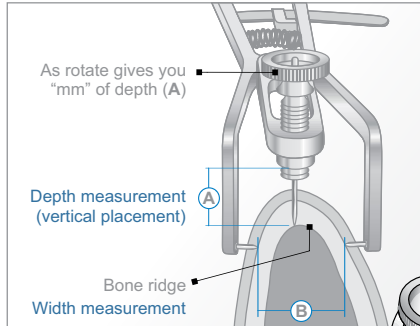

DB-300

Schieblehre für Implantologie / Drei-Dimensional
Implantology Calliper / Tridimensional
Calibro per Implantologie / Tridimensionale
Calibre para Implantologia / Tridimensional
Calibre pour Implantologie / Tridimensionnel

BONE BLOCK CLAMP

Bone Holding Clamps / Knochenhalteklammern / Daviers à os
Pinzas de sujeción para hueso / Pinze per fissare l'osso

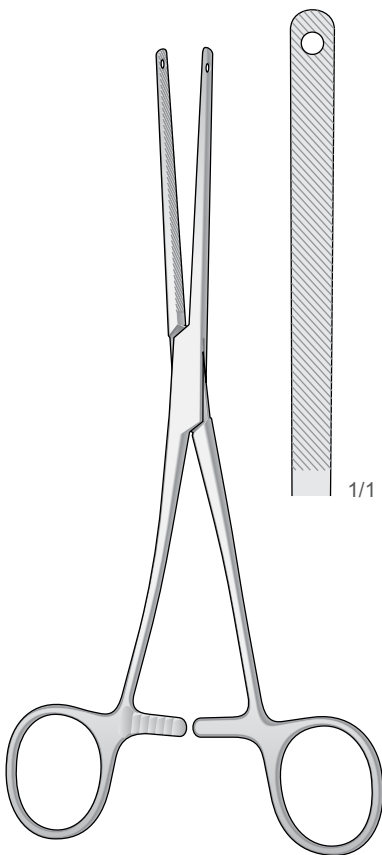

P-340
220 mm

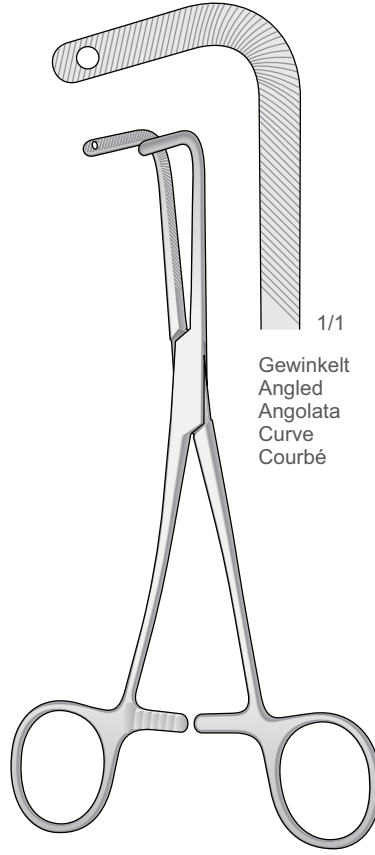

P-341
200 mm

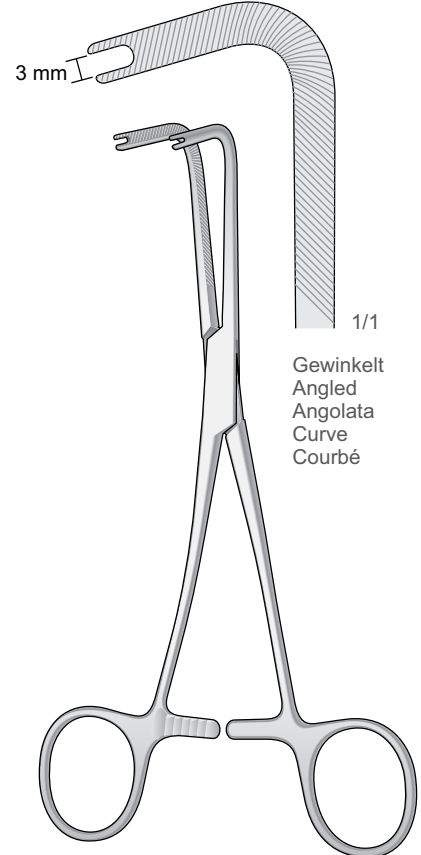

P-342
200 mm

Retractors - Bone Holding Forceps

Retraktoren - Knochenhaltezange

Divaricatori - Pinza per fissare l'osso

Separadores - Pinzas para sujeción para hueso

Écarteurs - Daviers à os

Tibia Wundspreizer
Tibial and Iliac Retractor
Divaricatore per tibia e cresta iliaca
Separadores tibiales e iliacos
Écarteur pour tibia e crête iliaque

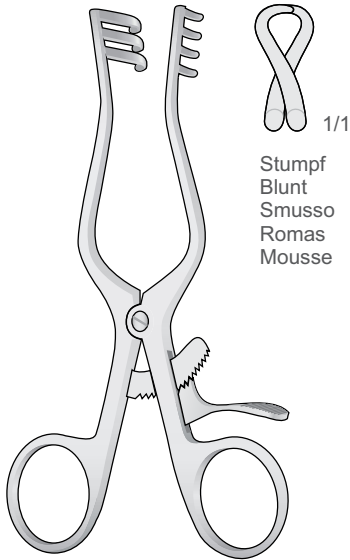

WEITLANER
BV-23
165 mm

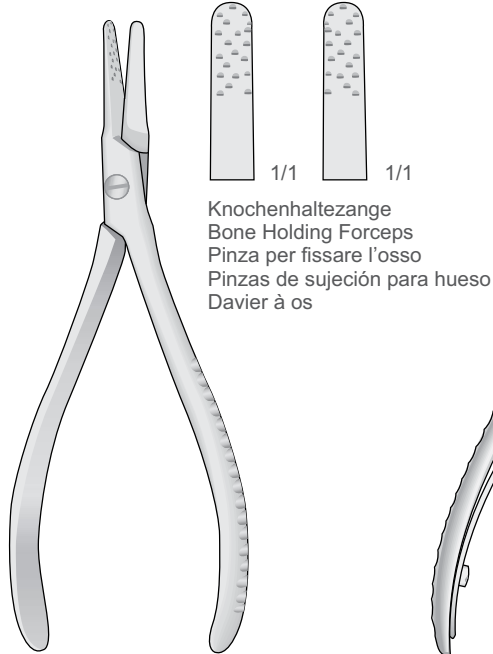

RADOLF
FO-159
135 mm

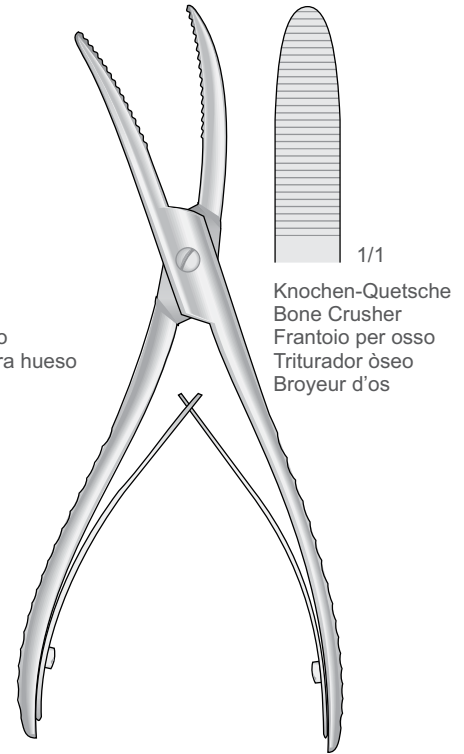

WOLFF
LX-113
180 mm

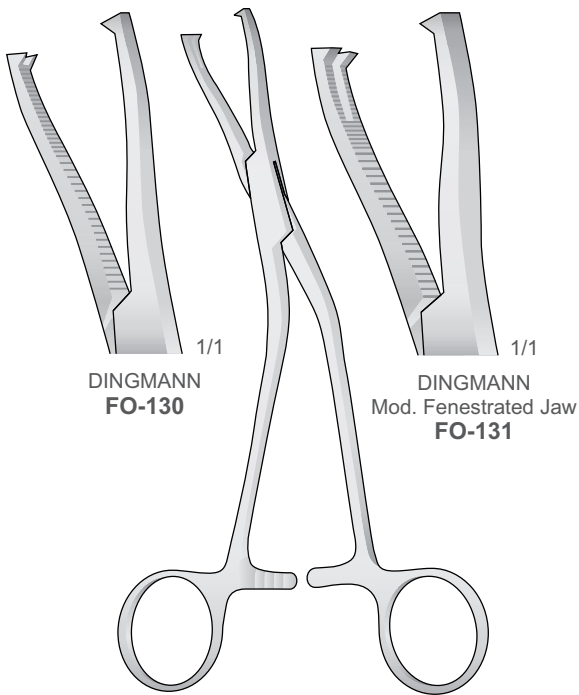

DINGMANN
FO-130

DINGMANN
Mod. Fenestrated Jaw
FO-131

DINGMANN
FO-130/FO-131
190 mm

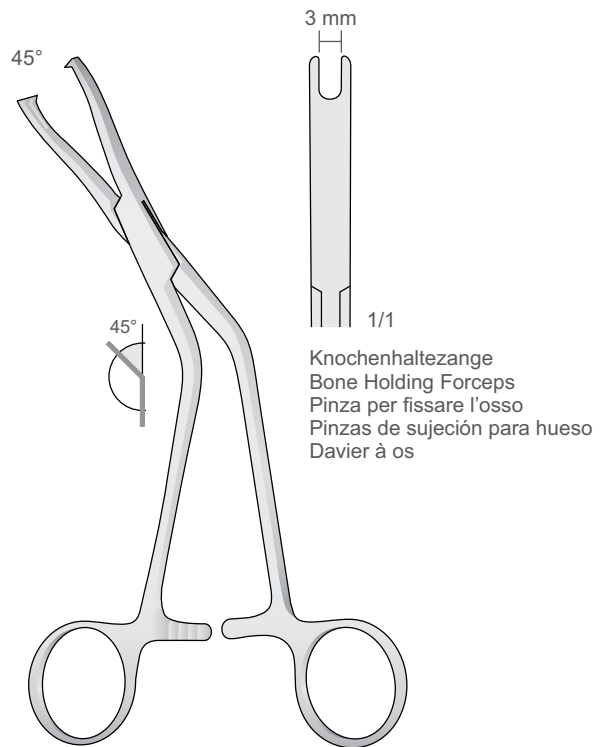

DINGMANN - Mod. Fenestrated Jaw
FO-131S
190 mm

MSD

CURETTES & BONES



Periosteals (Raspatories)

Raspatorien
 Scollaperiostei (Periostotomi)
 Periostótomos (Legras)
 Rugines périostiques

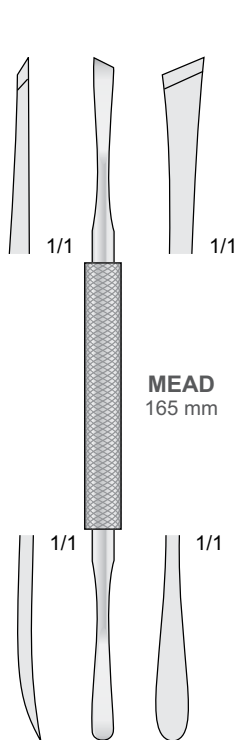

MEAD
165 mm

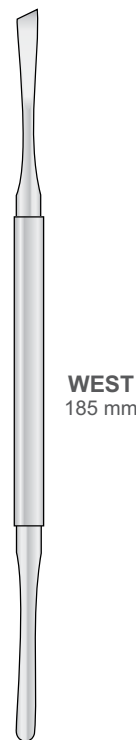

WEST
185 mm

PERIOSTEAL ELEVATORS

PERIOSTEAL RASPATORIES

Scharf - Sharp - Taglienti - Cortante - Tranchant

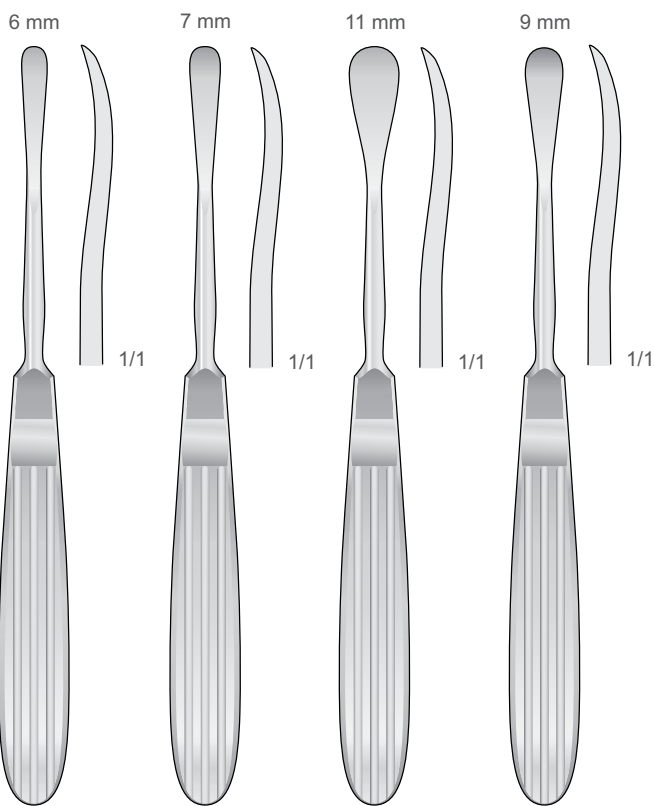

OBWEGESER DO-59
175 mm

OBWEGESER DO-63
175 mm

OBWEGESER DO-65
175 mm

OBWEGESER DO-67
175 mm

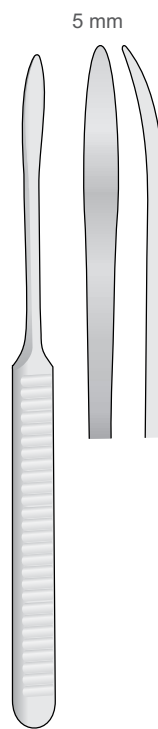

WILLIGER WG-10
165 mm

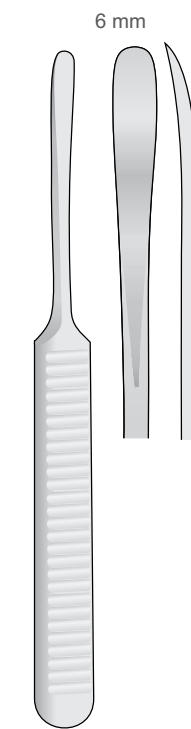

WILLIGER WG-12
160 mm

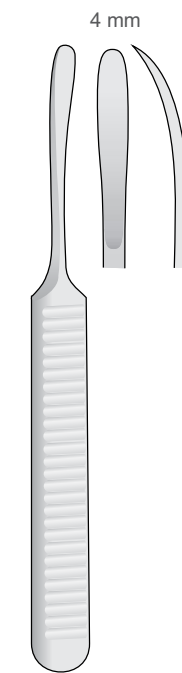

WILLIGER WG-14
140 mm

Raspatories - Elevators

Raspatorien - Elevatorien

Periostotomi - Elevatori

Legras - Elevadores

Rugines - Elevateurs

Rugines - Elevateurs

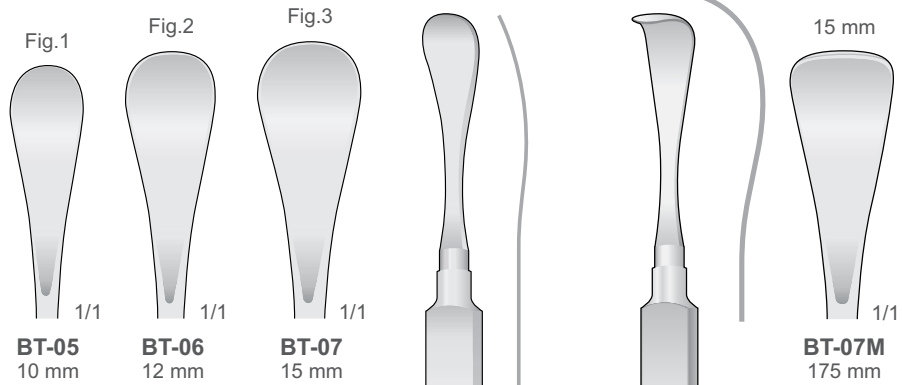

Halbscharf
Semi-Scharp
Semitagliente
Semicortante
Semitranchant

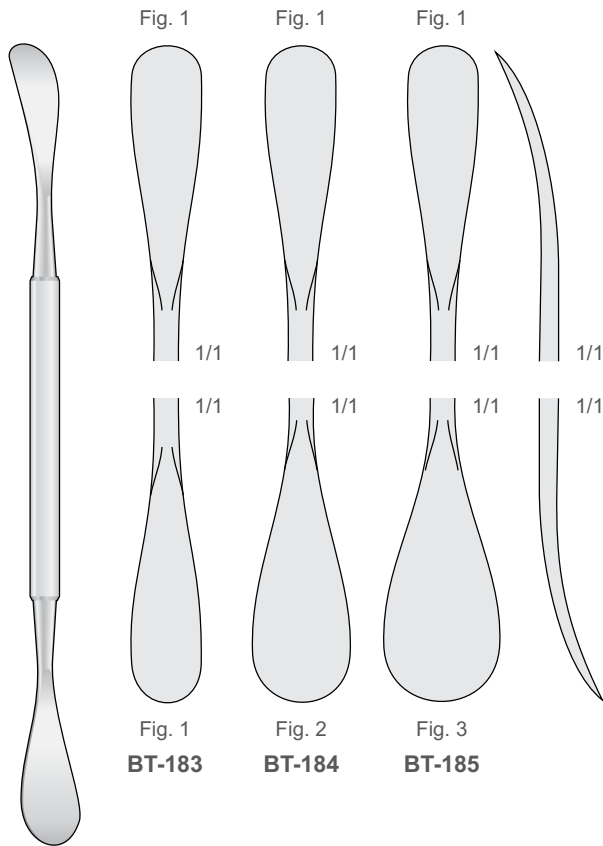

HENAHAN
BT-183/BT-185
200 mm

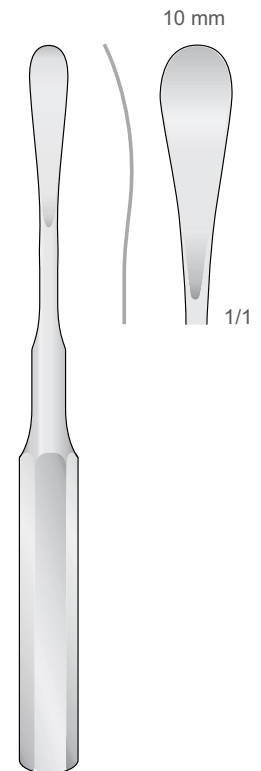

MOLT
MO-15
160 mm

Raspatories - Elevators

Raspatorien - Elevatorien

Periostotomi - Elevatori

Legras - Elevadores

Rugines - Elevateurs

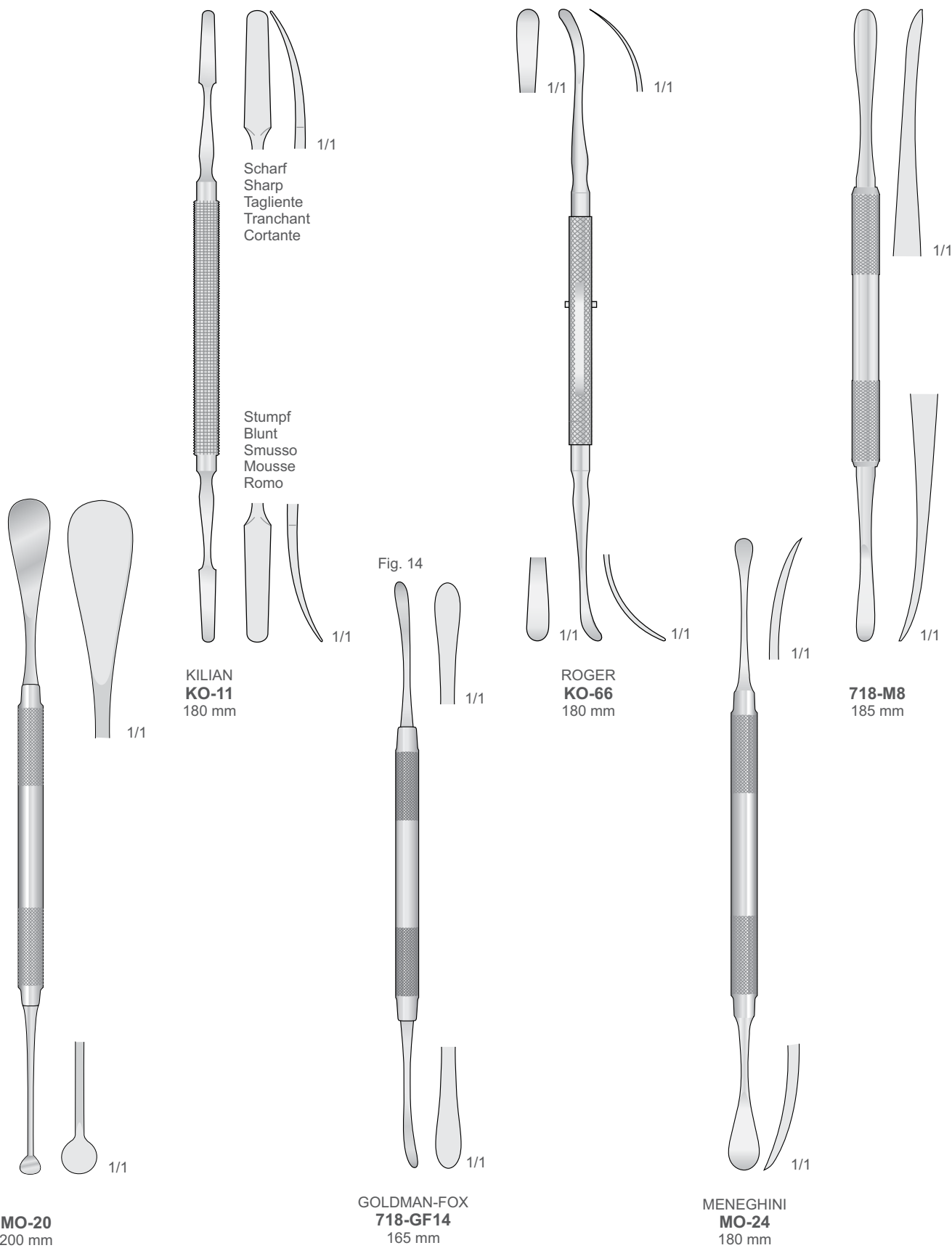

Raspatories - Elevators

Raspatorien - Elevatorien
 Periostotomi - Elevatori
 Legras - Elevadores
 Rugines - Elevateurs

Periosteals / Currettes / Bone

Periost / Küretten / Knochen
 Périosteales / Curettes / Os
 Periostali / Curette / Osso
 Nadkostnitsy / Kyuretki / Kost'

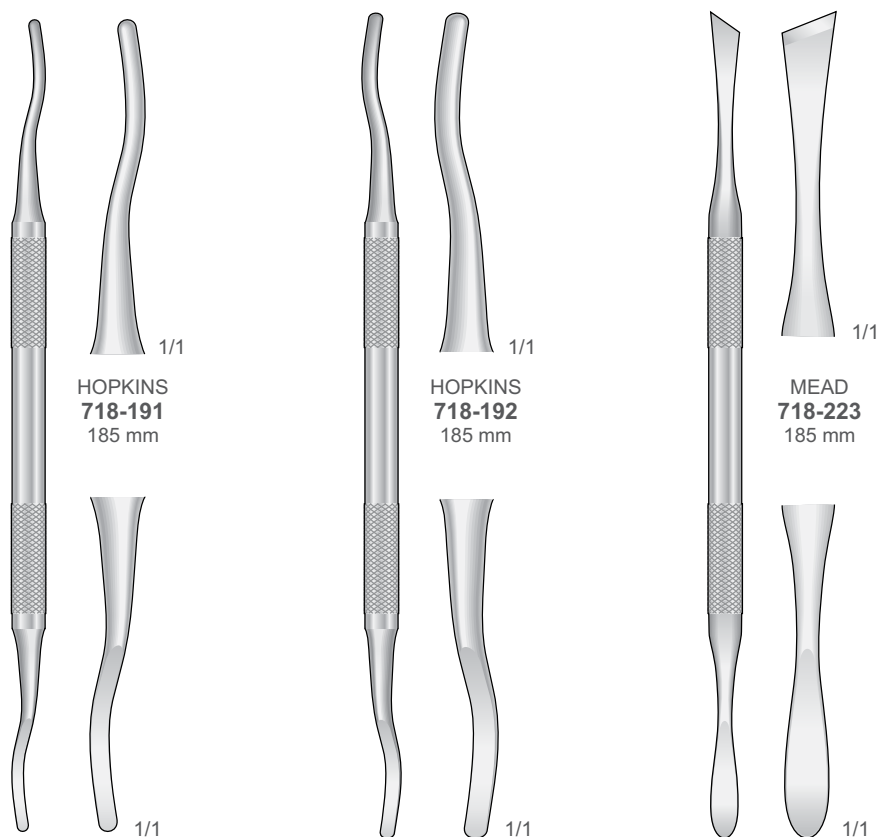

Legras - Elevadores
 Rugines - Elevateurs

Instrumente für Sinuslift / Sinus Lift Instruments / Strumenti per rialzo del seno
 Instrumentos para elevación de seno maxilar / Instruments d'élévation sinusienne

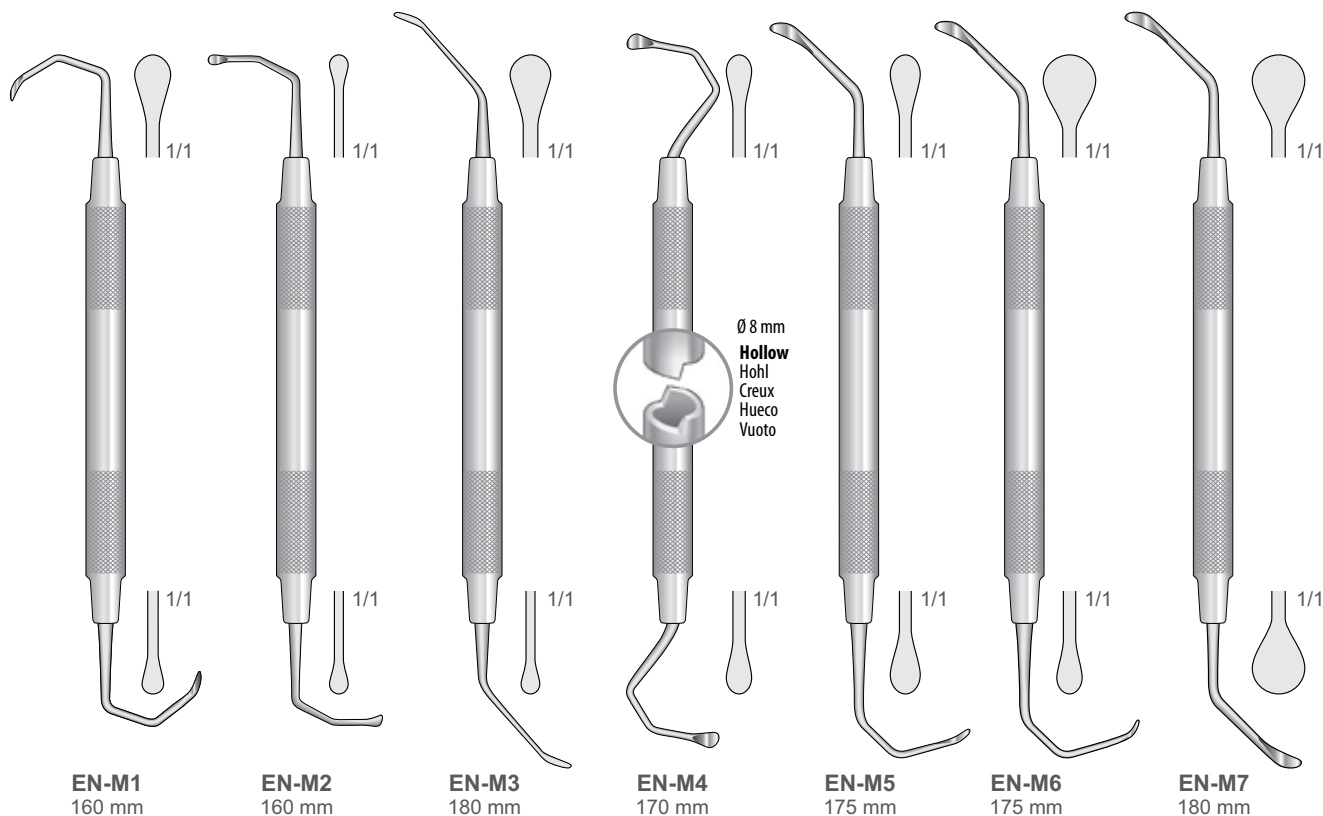

EN-M1
160 mm

EN-M2
160 mm

EN-M3
180 mm

EN-M4
170 mm

EN-M5
175 mm

EN-M6
175 mm

EN-M7
180 mm

Raspatories - Elevators

Raspatorien - Elevatorien

Periostotomi - Elevatori

Legras - Elevadores

Rugines - Elevateurs

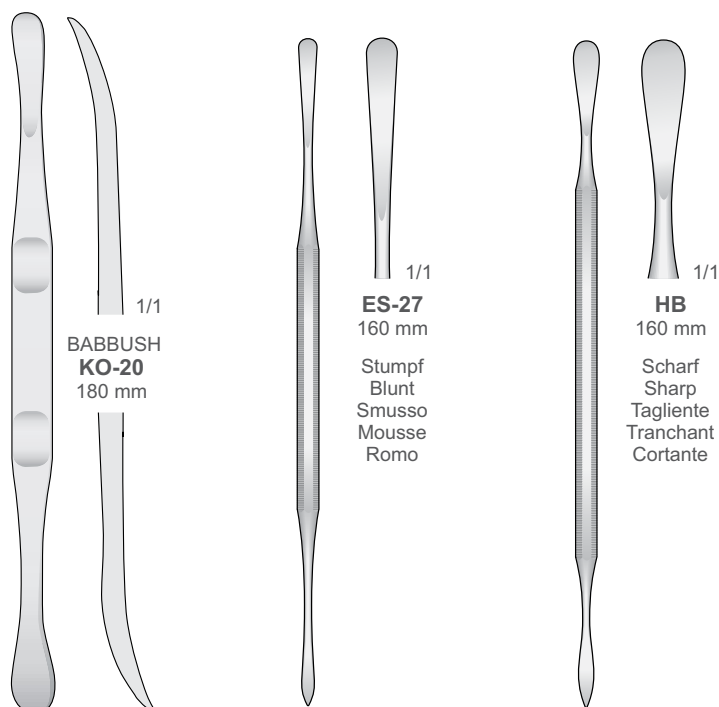

Instrumente für Sinuslift
Sinus Lift Instruments
Strumenti per rialzo del seno
Instrumentos para elevación de seno maxilar
Instruments d'élevation sinusienne

Fig. 24G

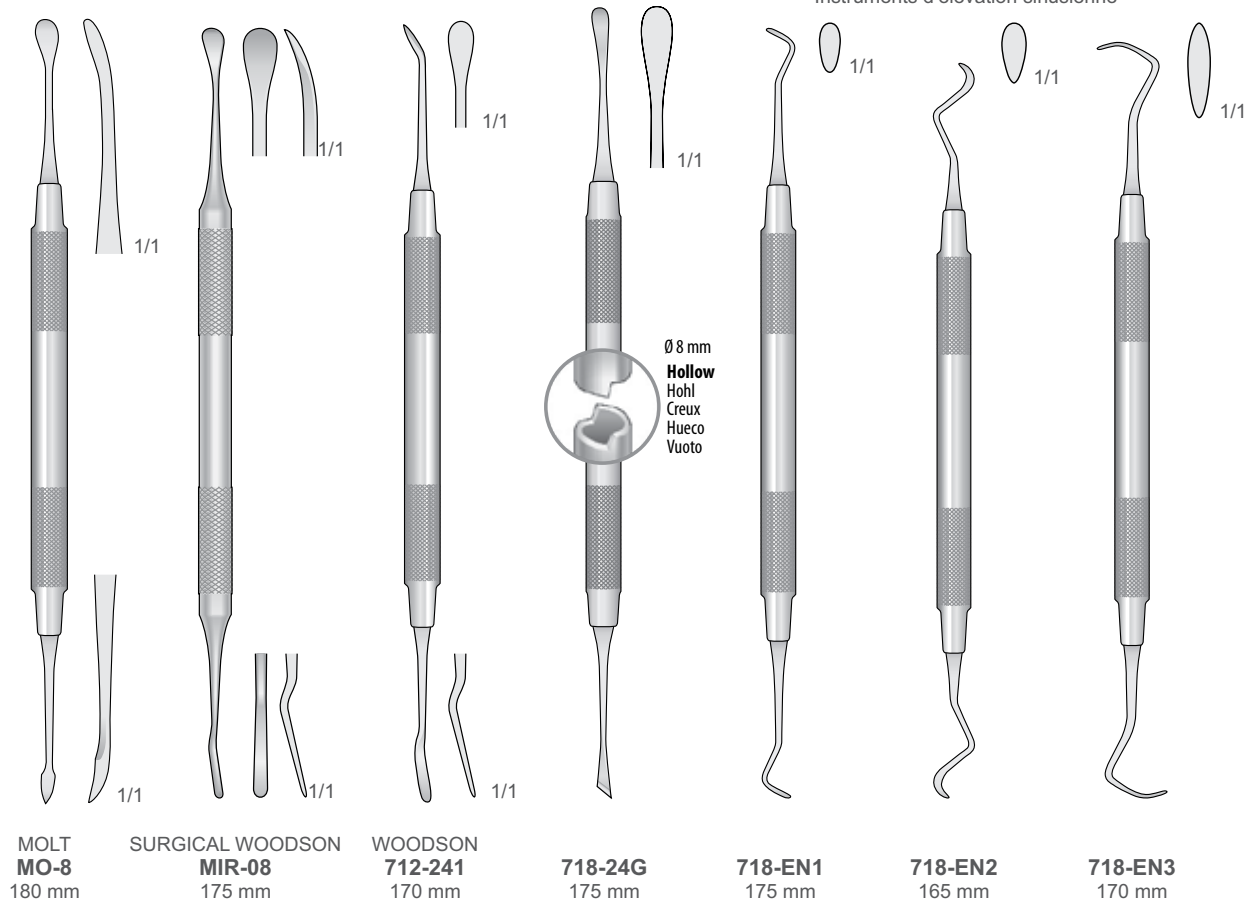

Raspatories - Elevators

Raspatorien - Elevatorien

Periostotomi - Elevatori

Legras - Elevadores

Rugines - Elevateurs

Periosteals / Curettes / Bone

Periost / K retten / Knochen

P riosteales / Curettes / Os

Periostali / Curette / Osso

Nadkostnitsy / Kyuretki / Kost'

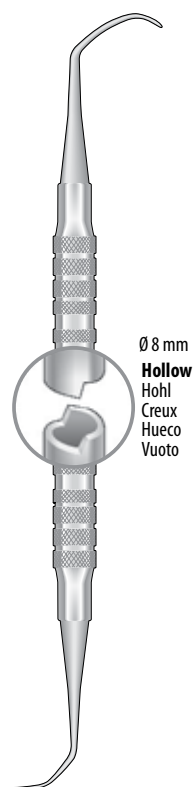

TASO-1

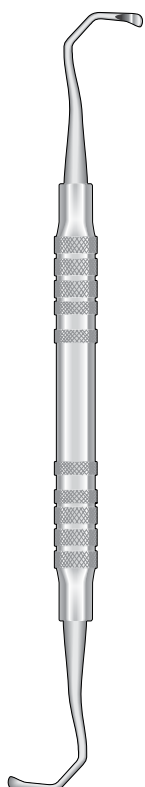

TASO-2

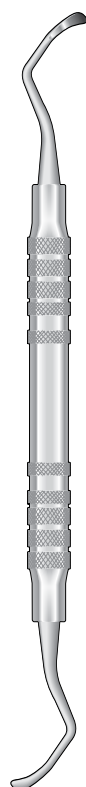

TASO-3

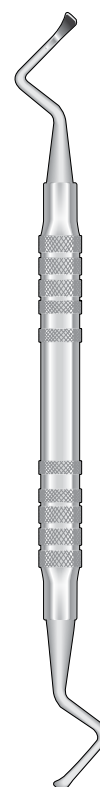

TASO-4



TASO-5

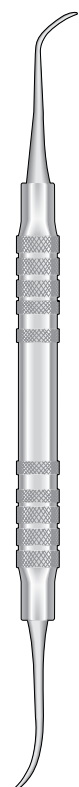

TASO-6

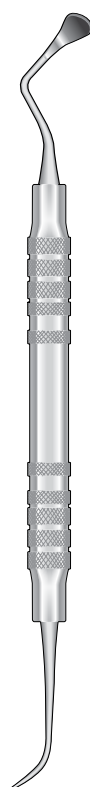

TASO-7

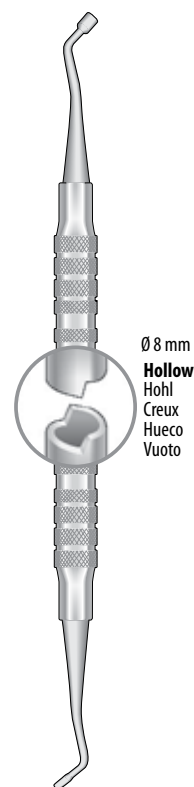

TASO-8

Raspatories

Raspatorien
Periostotomi
Legras
Rugines

Curettes
Küretten
Curettes
Curetas
Curettes

Instrumente für Sinuslift
Sinus Lift Instruments
Strumenti per rialzo del seno
Instrumentos para elevación de seno maxilar
Instruments d'élévation sinusienne

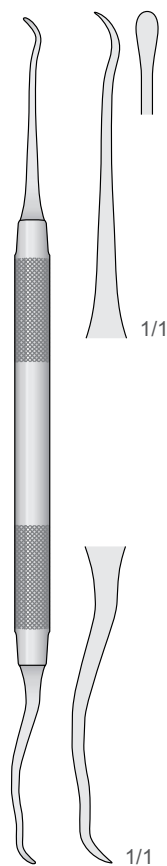
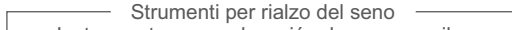
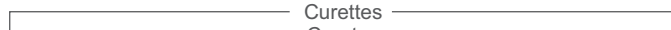

**MILLER-COLBURN
CU-MC1**
185 mm

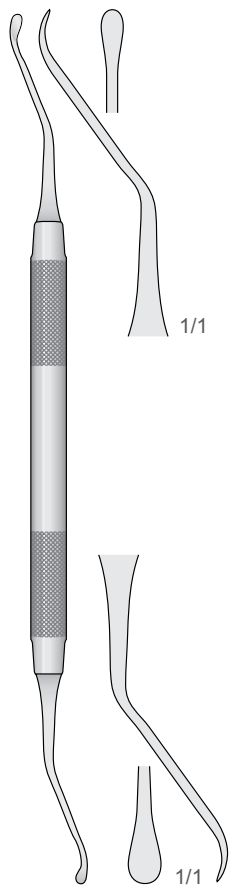

**MOLT
MO-12**
190 mm

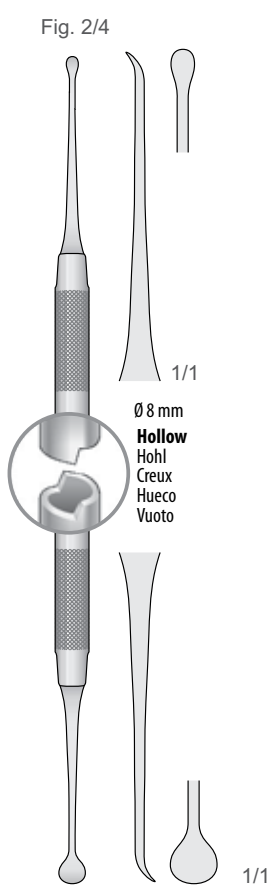

**MOLT
MO-10**
180 mm

Ø 8 mm
Hollow
Hohl
Creux
Hueco
Vuoto

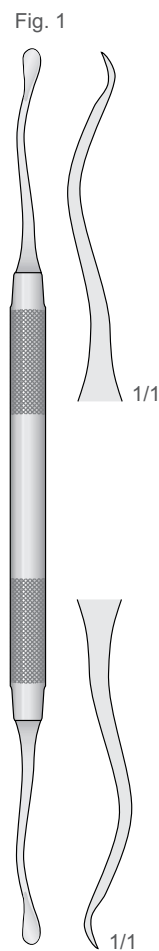

SL-1
200 mm

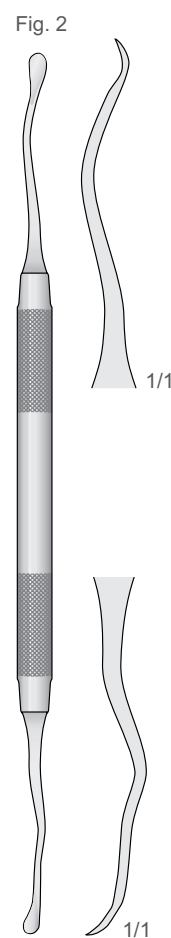

SL-2
195 mm

Curettes

Küretten
Curettes
Curetas
Curettes

Periosteals / Curettes / Bone

Periost / Küretten / Knochen
Périosteales / Curettes / Os
Periostali / Curette / Osso
Nadkostnitsy / Kyuretki / Kost'



Runder Hohlgriff 8 mm
Hollow Round Handle 8 mm
Manico tondo vuoto 8 mm
Mango hueco 8 mm
Manche rond vide 8 mm

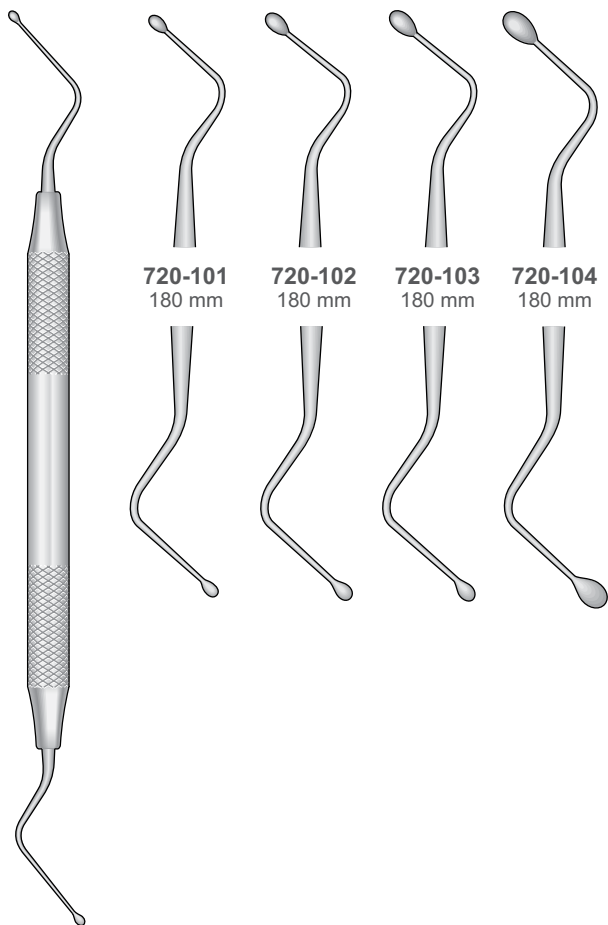

720-101
180 mm

720-102
180 mm

720-103
180 mm

720-104
180 mm

HEMINGWAY
720-101/720-104
180 mm

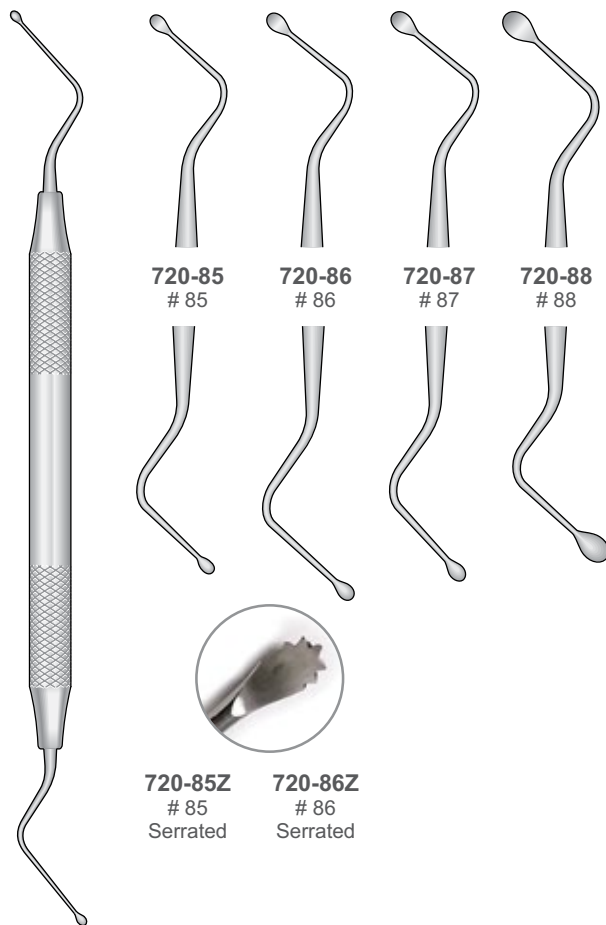

720-85
85

720-86
86

720-87
87

720-88
88

720-85Z
85
Serrated

720-86Z
86
Serrated

LUCAS
720-85/720-88
180 mm

Curettes

Küretten
Curettes
Curetas
Curettes

Wundhachen Mandibular
Mandibular Nerve Displace
Per spostamento
nervo mandibolare
Para nervo mandibular

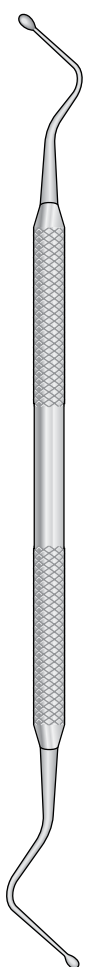

HEMINGWAY
C-1
170 mm

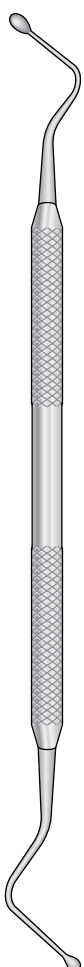

HEMINGWAY
C-2
170 mm

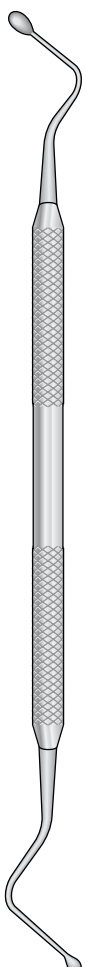

HEMINGWAY
C-3
170 mm

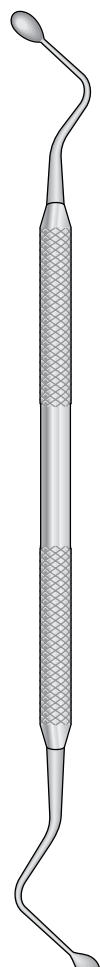

HEMINGWAY
C-4
170 mm

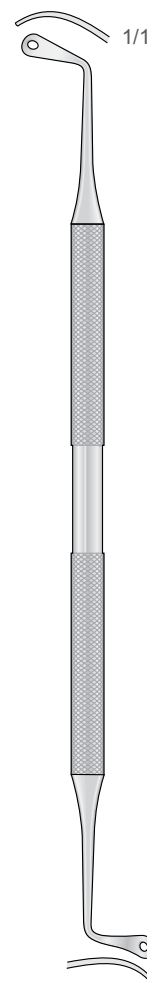

SL-21
165 mm

Curettes

Küretten
Curettes
Curetas
Curettes

Periosteals / Curettes / Bone

Periost / Küretten / Knochen
Périosteales / Curettes / Os
Periostali / Curette / Osso
Nadkostnitsy / Kyuretki / Kost'

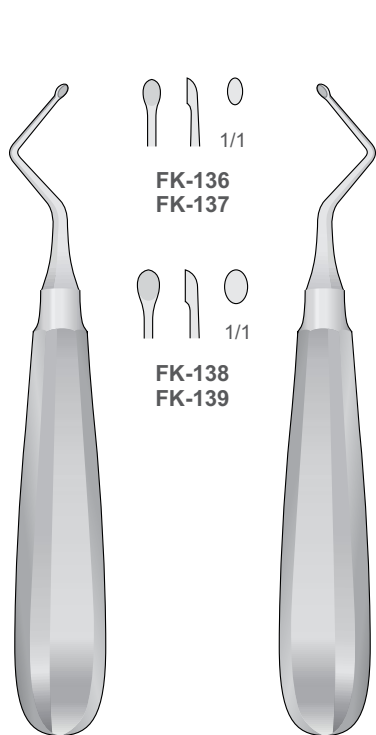

KERPEL
FK-136
FK-138
145 mm

KERPEL
FK-137
FK-139
145 mm



DL-50
155 mm

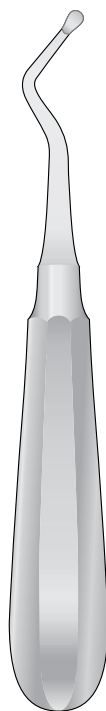

DL-51
150 mm

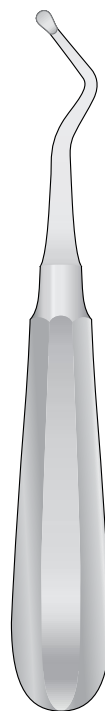

DL-52
150 mm

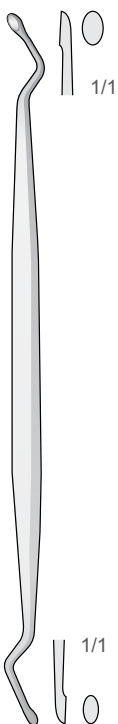

FK-83
160 mm

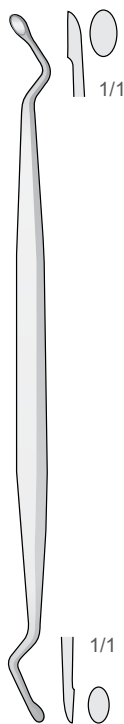

JANZEN
FK-84
160 mm

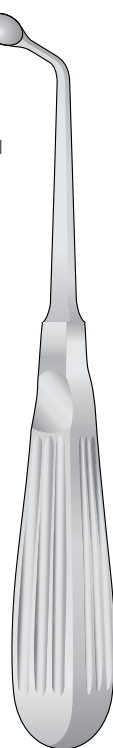
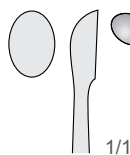

UFFENORDE
FK-188
170 mm

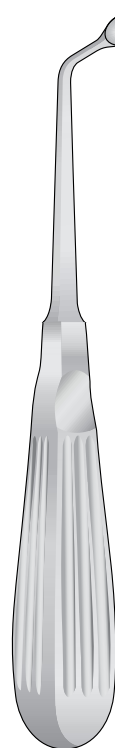
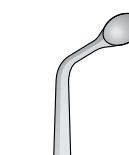

UFFENORDE
FK-189
170 mm

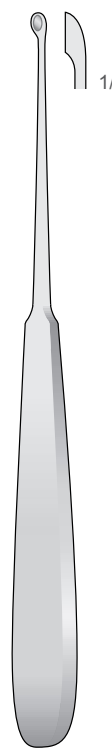
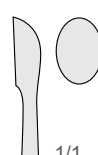

WILLIGER
FK-197/FK-198
170 mm

Fig. 00
3,4 mm



FK-197

Fig. 1
5,2 mm



FK-198

Curettes

Küretten
Curettes
Curetas
Curettes

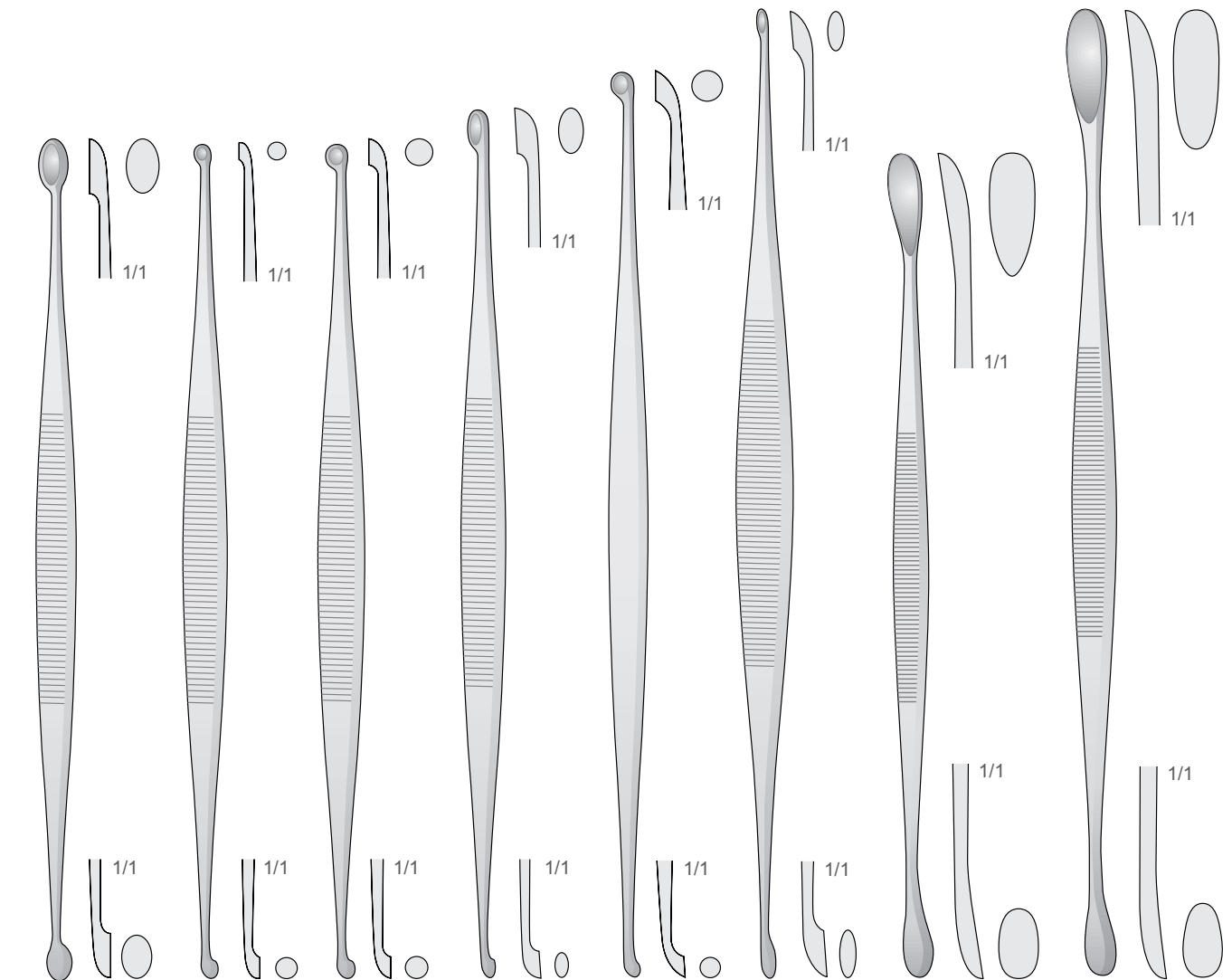

JACOBSON
FK-75
140 mm

MARTINI
FK-70
140 mm

MARTINI
FK-76
140 mm

WILLIGER
FK-71
145 mm

JANSEN
FK-77
160 mm

BARTH
FK-78
180 mm

VOLKMANN
FK-72
145 mm

VOLKMANN
FK-73
170 mm

Curettes

Küretten
Curettes
Curetas
Curettes

Periosteals / Curettes / Bone

Periost / Küretten / Knochen
Périosteales / Curettes / Os
Periostali / Curette / Osso
Nadkostnitsy / Kyuretki / Kost'

Curettes

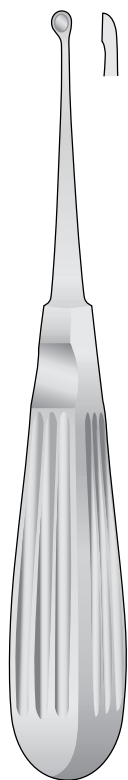

VOLKMANN
FK-60/FK-67
170 mm

Fig.0000
2,8 mm



FK-60

Fig.000
3,6 mm



FK-61

Fig.00
4,4 mm



FK-62

,Fig.0
5,2 mm



FK-63

Fig.1
6,8 mm



FK-64

Fig.2
8,5 mm



FK-65

Fig.3
10 mm



FK-66

Fig.4
11,5 mm



FK-67

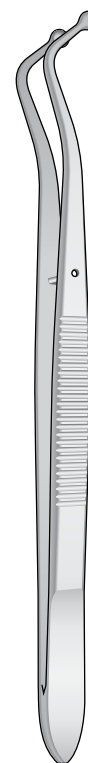

COLLEGE
CURETTE
MIR-10
160 mm

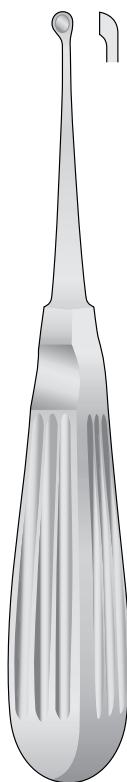

BRUNS
FK-110/FK-116
165 mm

3 mm



FK-110

4 mm



FK-111

5 mm



FK-112

6 mm



FK-113

8 mm



FK-114

10 mm



FK-115

12 mm



FK-116

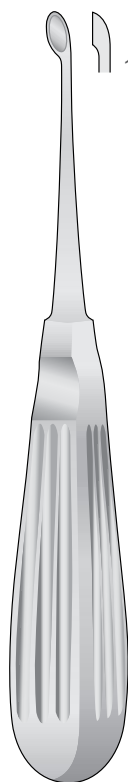

SCHEDE
FK-120/FK-126
170 mm

2,5 mm



FK-120

3,4 mm



FK-121

4,2 mm



FK-122

5,2 mm



FK-123

6,3 mm



FK-124

7,4 mm



FK-125

8 mm



FK-126

Surgical Curettes

Chirurgische Küretten
Curette chirurgiche
Curetas quirúrgicas
Curettes chirurgicales

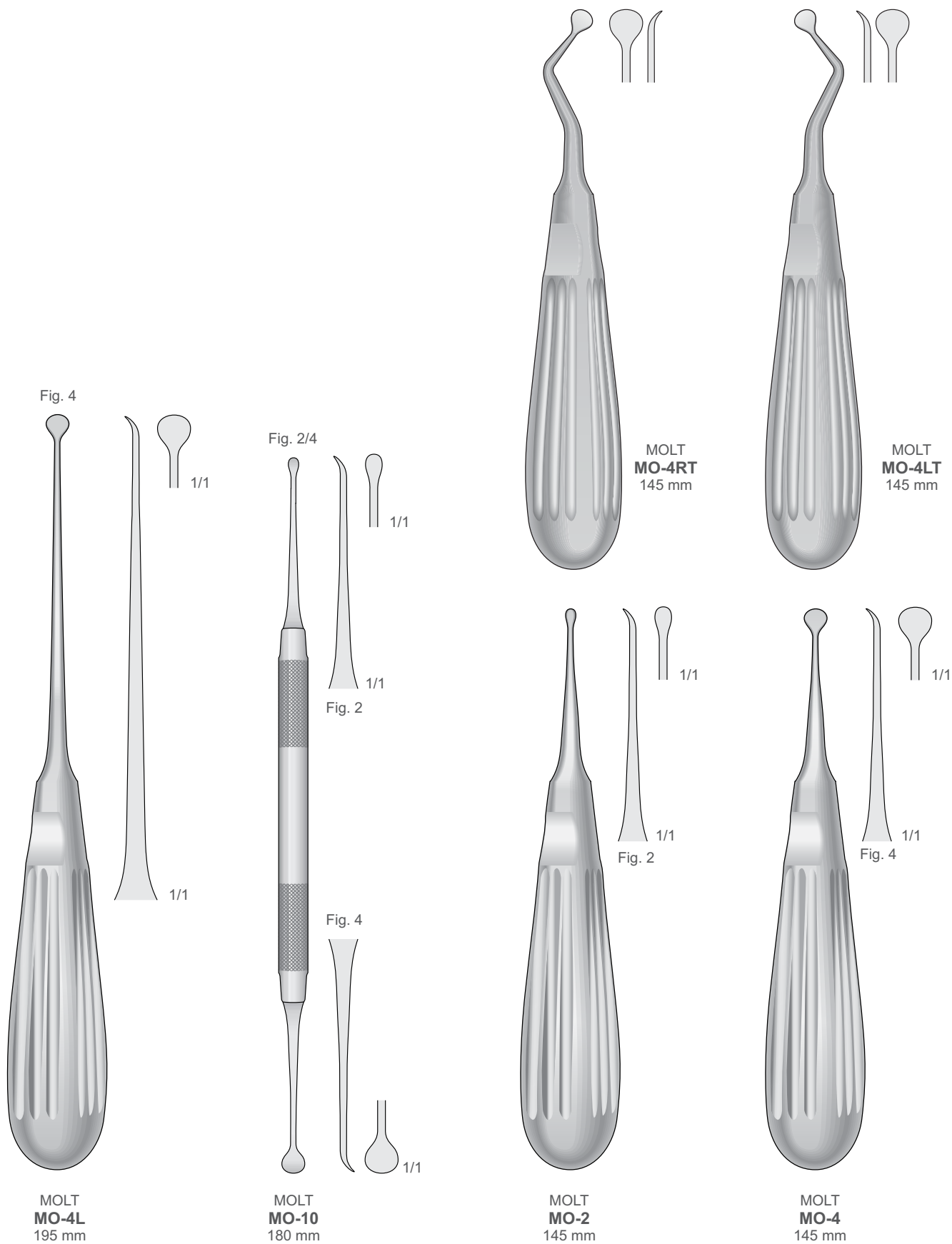

Bone Files

Knochenfeilen
Lime per osso
Limas para hueso
Limes à os

Periosteals / Curettes / Bone

Periost / Küretten / Knochen
Périosteales / Curettes / Os
Periostali / Curette / Osso
Nadkostnitsy / Kyuretki / Kost'

Fig. 67

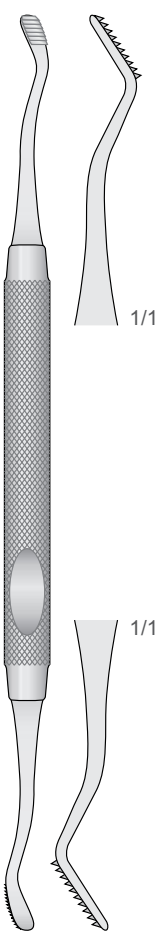

HOWARD
DO-1
180 mm

Fig. 45

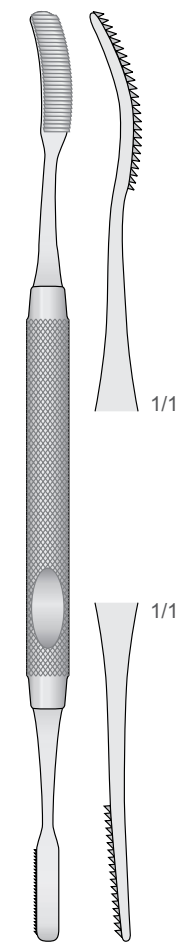

MILLER
DO-2
185 mm

Fig. 52

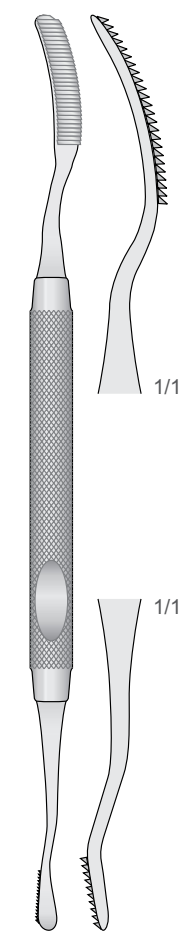

MILLER
DO-3
180 mm

Fig. 12

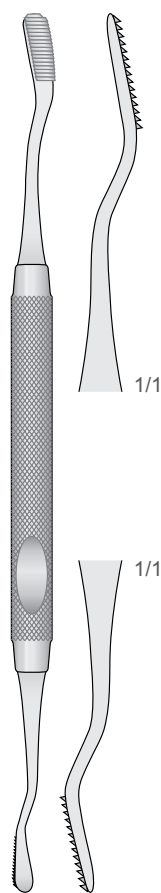

HOWARD
DO-4
170 mm

Fig. 12A

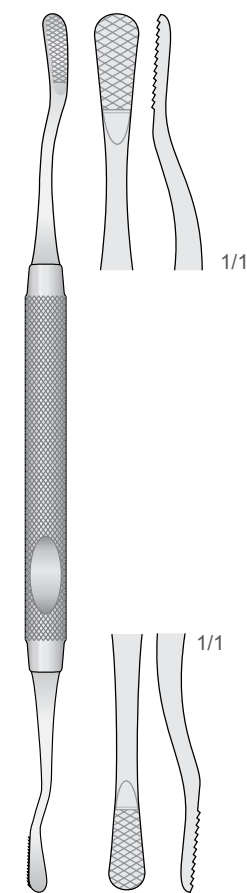

MILLER
DO-4C
170 mm

Fig. 64

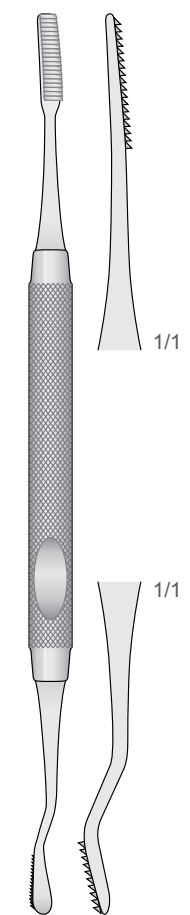

MILLER
DO-5
175 mm

Bone Files

Knochenfeilen
Lime per osso
Limas para hueso
Limes à os

Runder Hohlgriff 8 mm
Hollow Round Handle 8 mm
Manico tondo vuoto 8 mm
Mango hueco 8 mm
Manche rond vide 8 mm



Parodontal Feilen
Periodontal Files
Lime parodontali
Limas periodontales
Limes parodontales

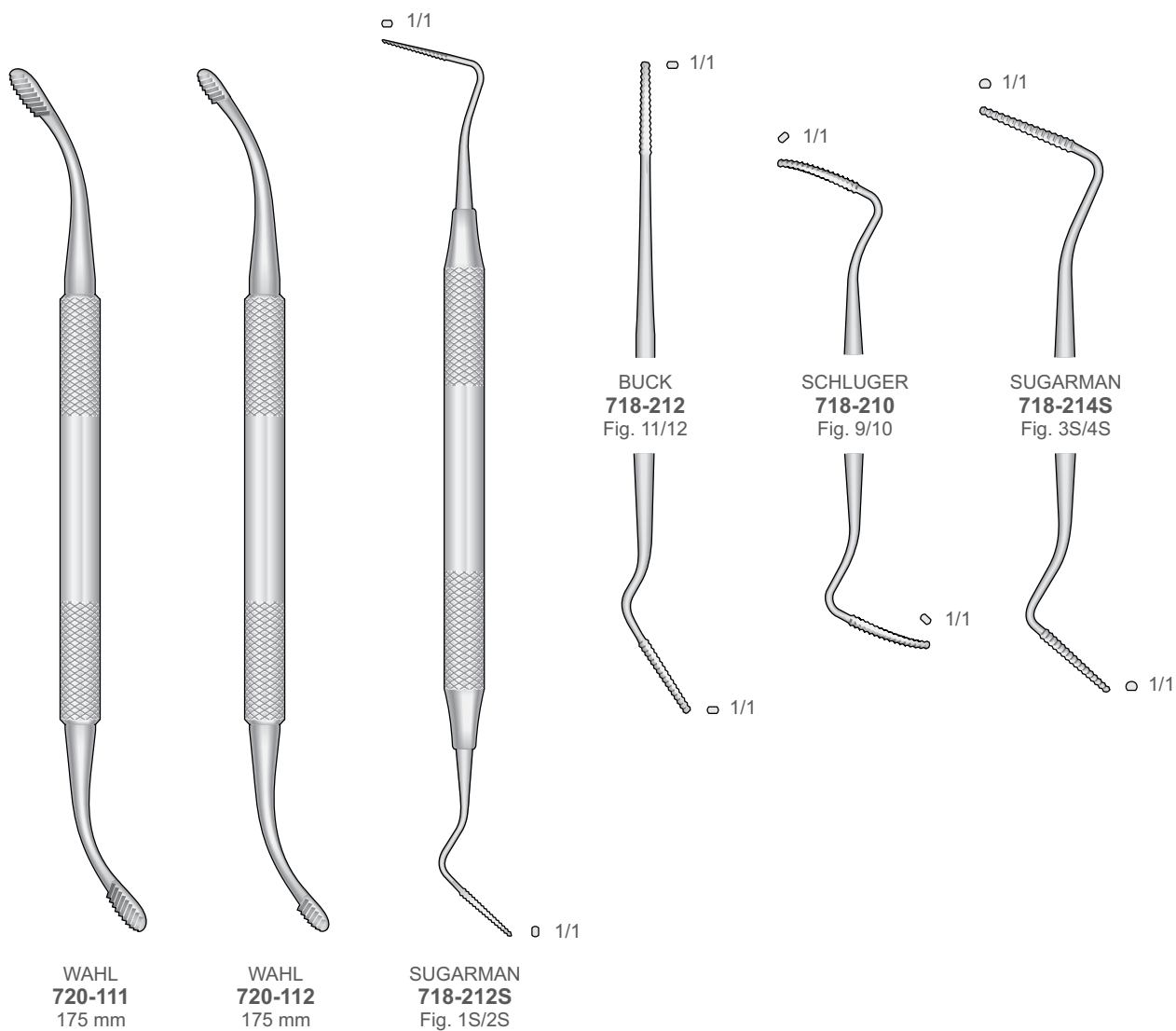

Tissue Nippers

Gewebezängchen
Tronchesi per gengive e tessuti
Pinzas para cortar tejidos
Pincés coupante pour tissue

Periosteals / Curettes / Bone

Periost / Küretten / Knochen
Périosteales / Curettes / Os
Periostali / Curette / Osso
Nadkostnitsy / Kyuretki / Kost'

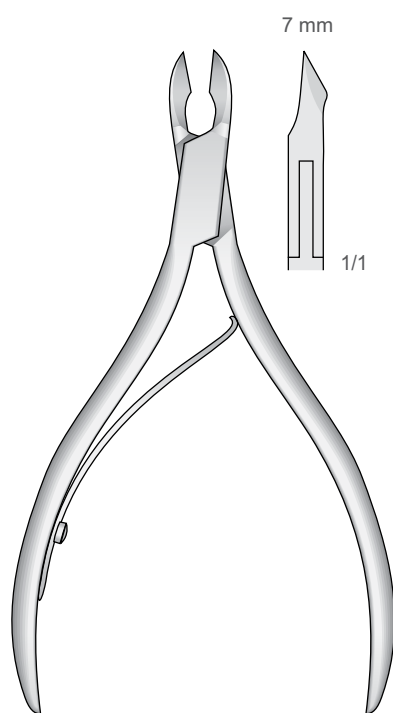

CHOEN
LX-60
105 mm

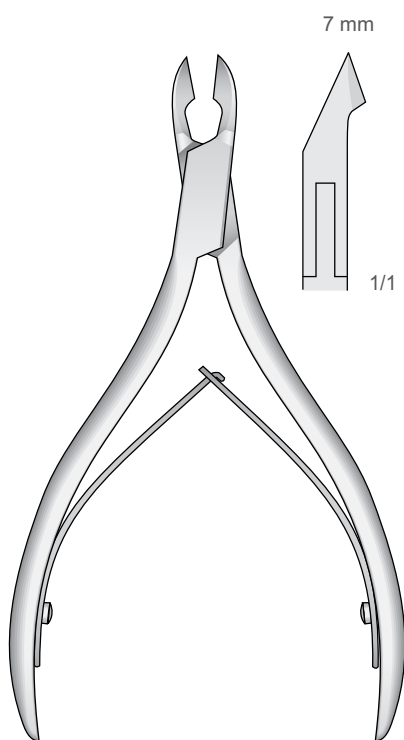

ILIC
LX-50
115 mm

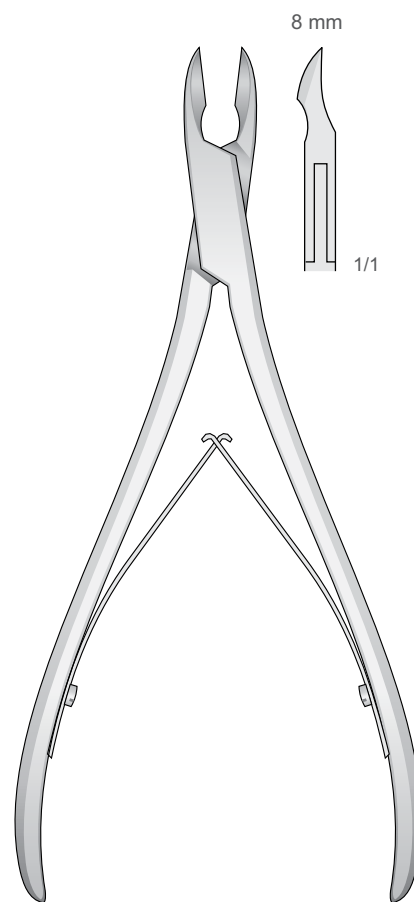

LX-52
140 mm

Bone rongeurs

Hohlmeißelzangen

Pinze ossivore

Pinzas gubias

Pinces gouges

S-Form

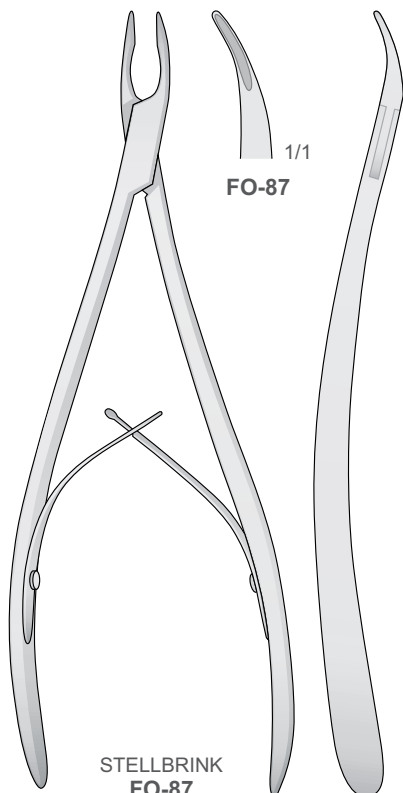

STELLBRINK
FO-87
190 mm

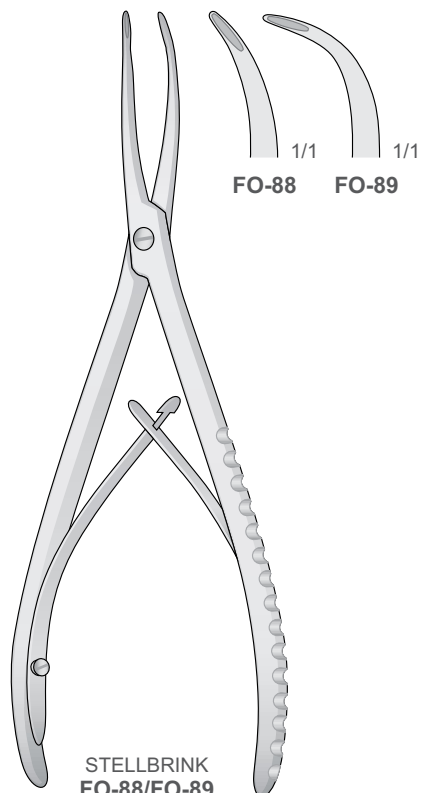

STELLBRINK
FO-88/FO-89
170 mm

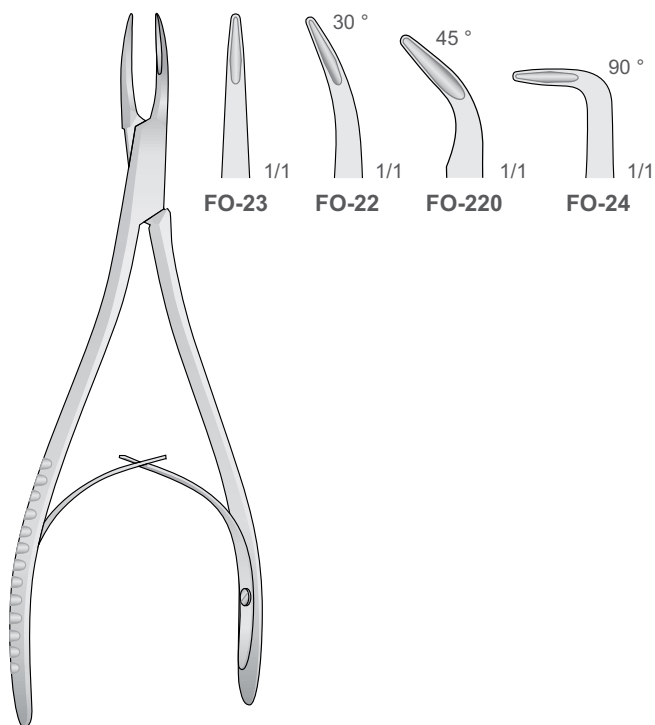

MINI-FRIEDMANN
FO-22/FO-220
150 mm

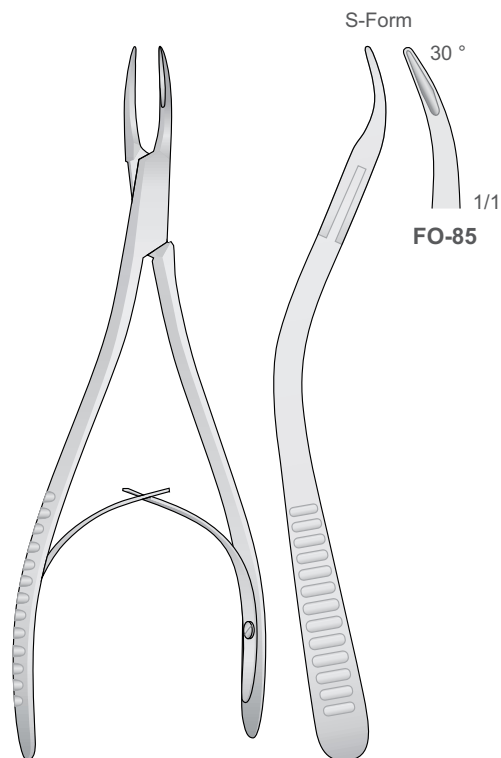

MINI-FRIEDMANN
FO-85
145 mm

Bone rongeurs

Hohlmeißelzangen
Pinze ossivore
Pinzas gubias
Pincas gouges

Periosteals / Curettes / Bone

Periost / Küretten / Knochen
Périosteales / Curettes / Os
Periostali / Curette / Osso
Nadkostnitsy / Kyuretki / Kost'

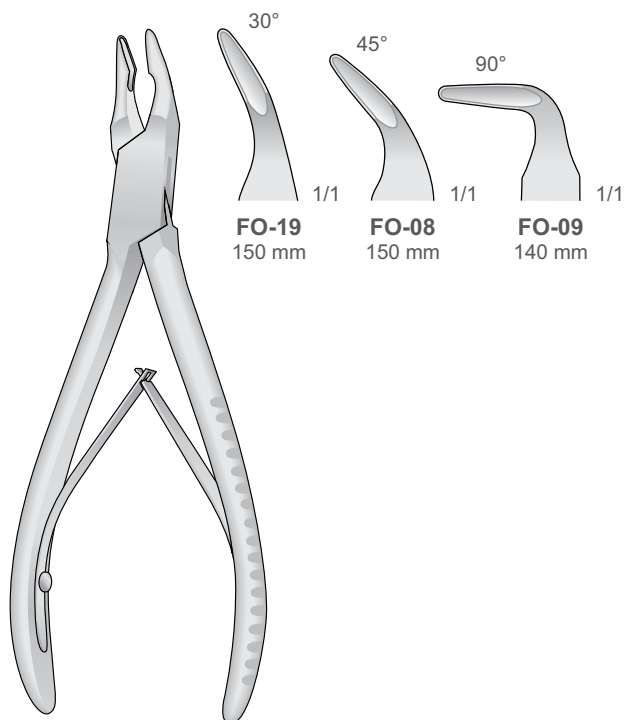

BLUMENTHAL
FO-08/FO-19

MINI FRIEDMAN
FO-15
120 mm

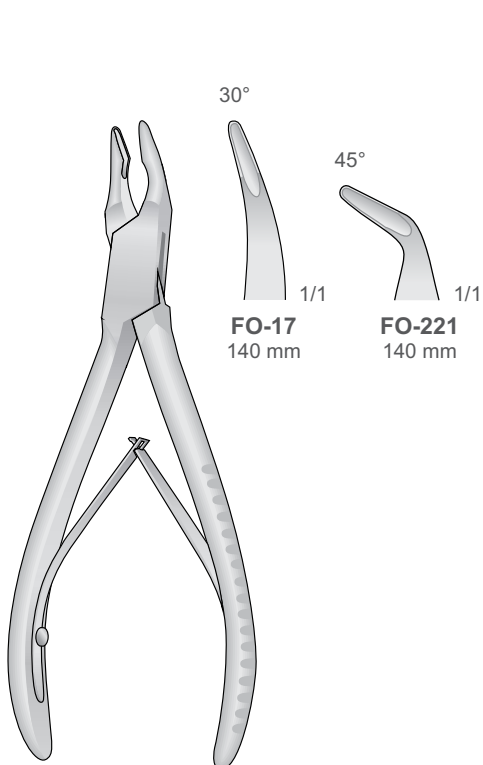

FRIEDMANN
FO-17/FO-221
140 mm

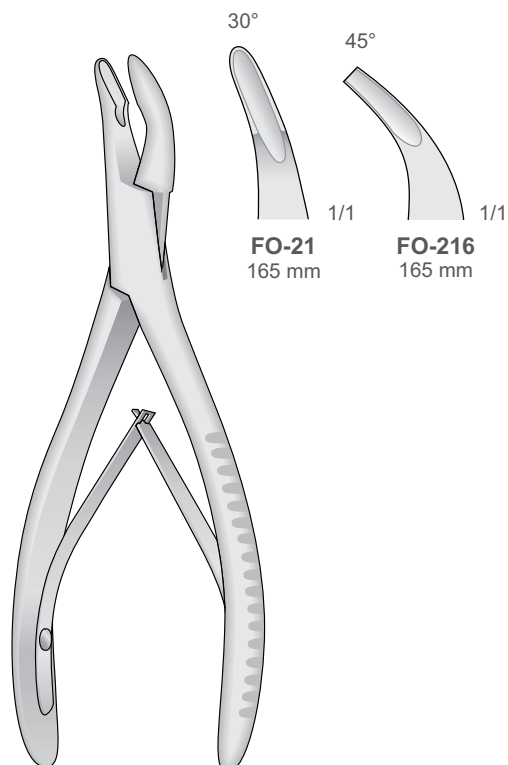

MEAD
FO-21/FO-216
165 mm

Bone rongeurs

Hohlmeißelzangen

Pinze ossivore

Pinzas gubias

Pinces gouges

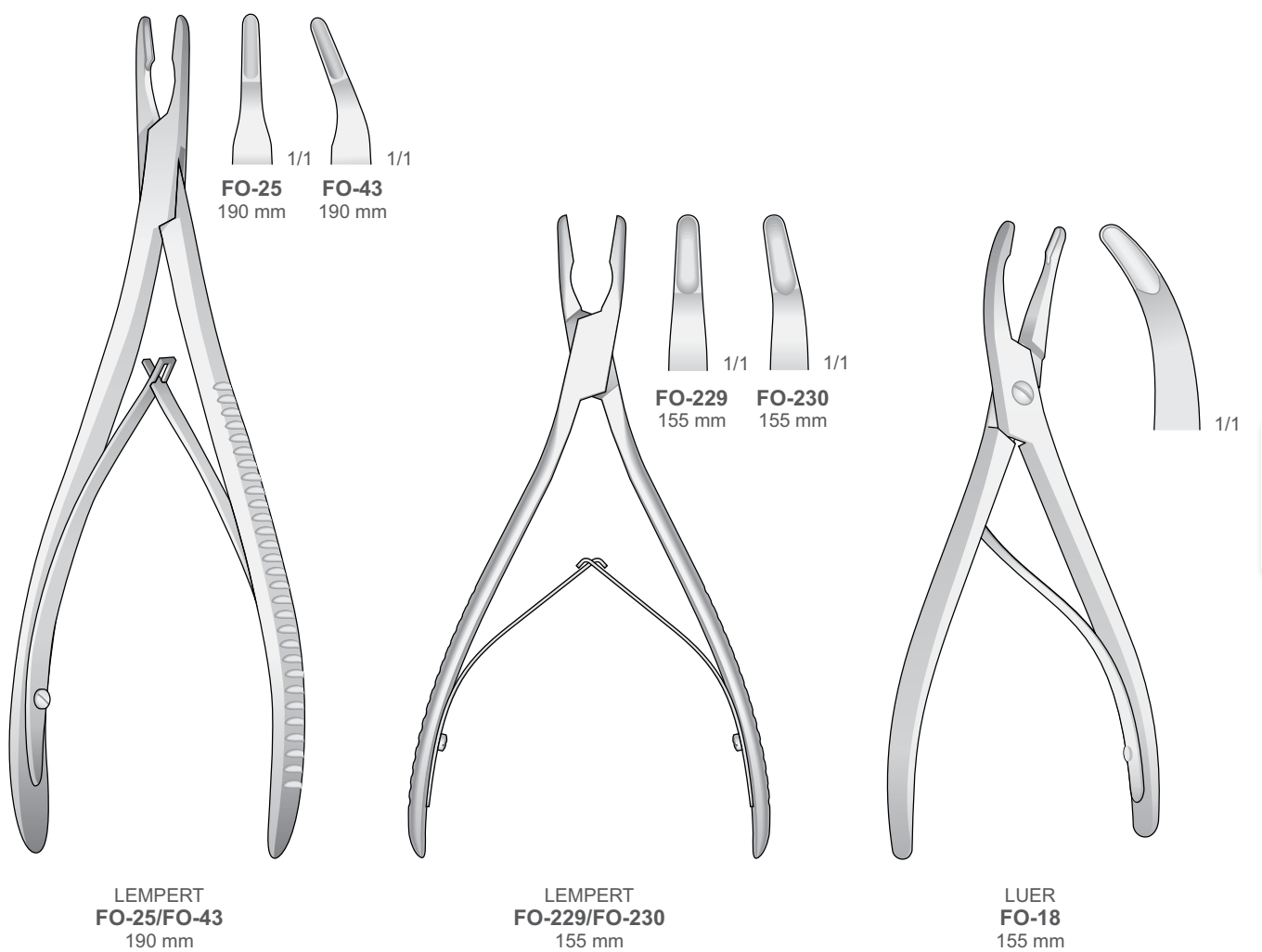

Bone rongeurs

Hohlmeißelzangen
Pinze ossivore
Pinzas gubias
Pincas gouges

Periosteals / Currettes / Bone

Periost / Küretten / Knochen
Périosteales / Curettes / Os
Periostali / Curette / Osso
Nadkostnitsy / Kyuretki / Kost'

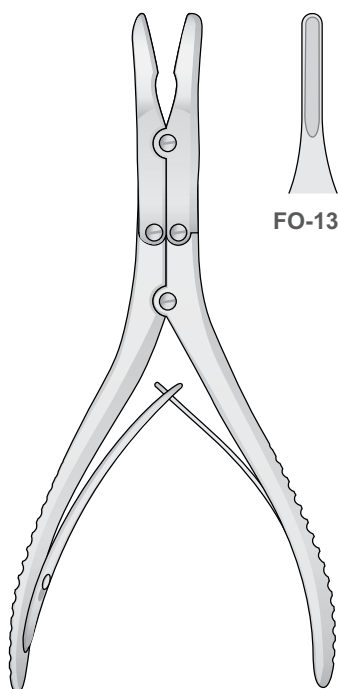

RUSKIN
FO-138/FO-139
150 mm

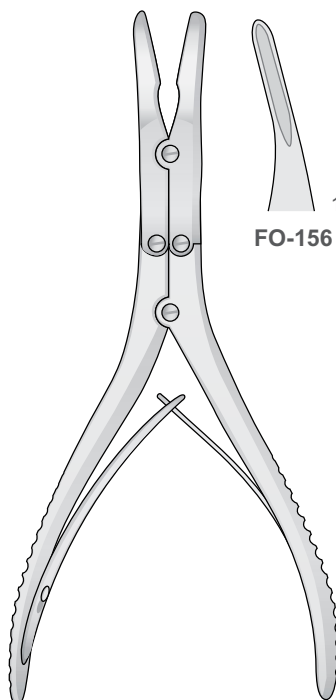
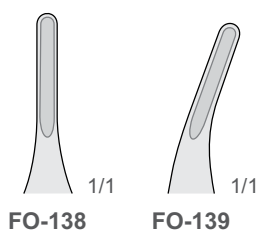

KLEINERT-KUTZ
FO-156/FO-157
155 mm

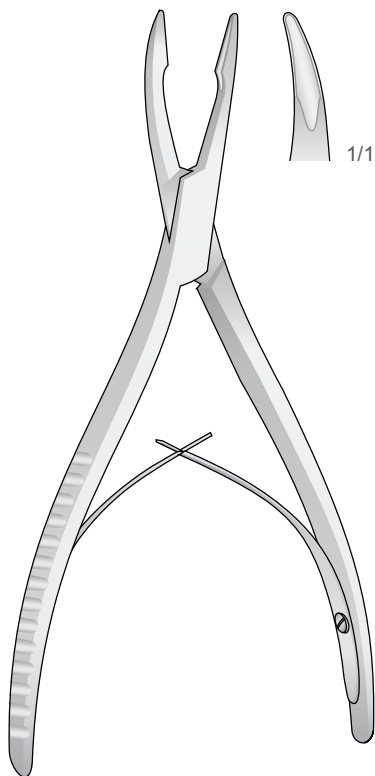
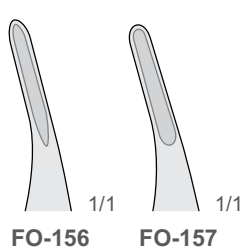

FRIEDMANN
FO-16
160 mm

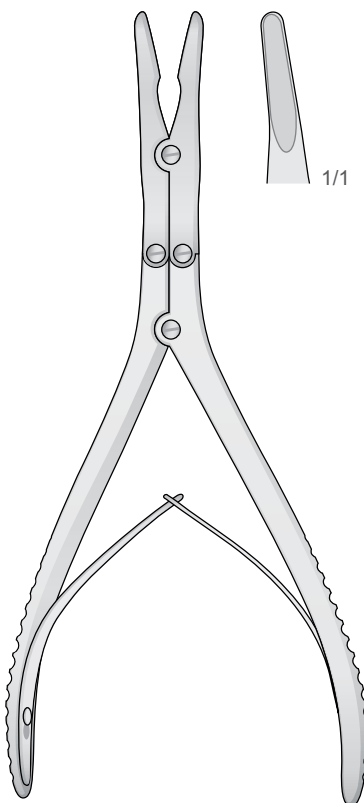
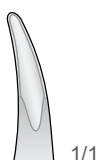

BEYER
FO-20
180 mm

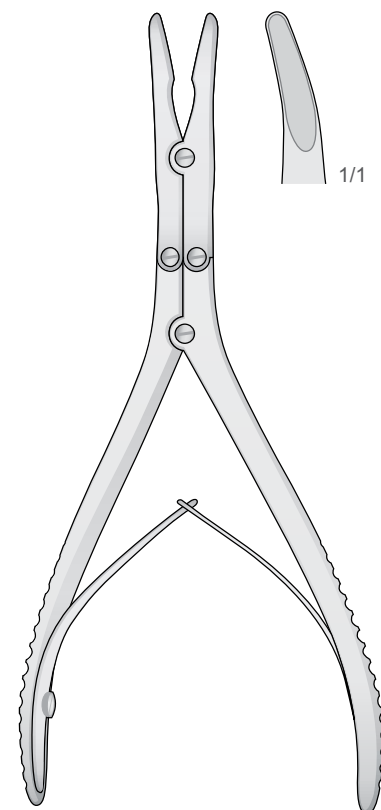
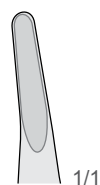

ZAUFAL-JANSEN
FO-34
180 mm

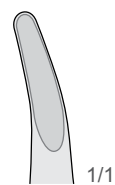

Bone rongeurs

Hohlmeißelzangen

Pinze ossivore

Pinzas gubias

Pinces gouges

Pinzas gubias
Pinces gouges

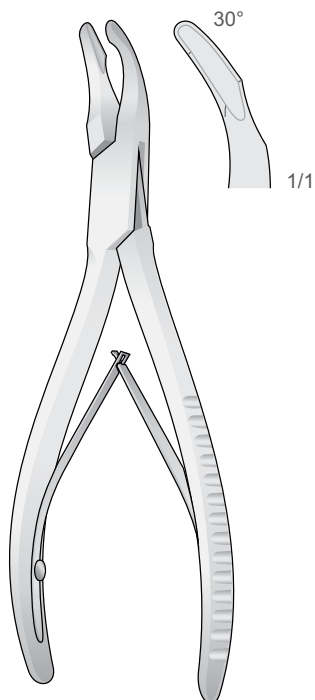

CLEVELAND
FO-231 140 mm
FO-232 170 mm

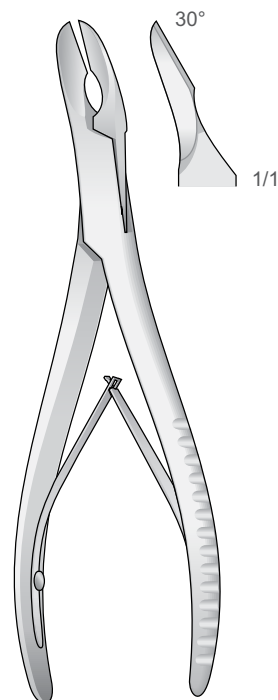

CLEVELAND
FO-233 150 mm
FO-234 170 mm

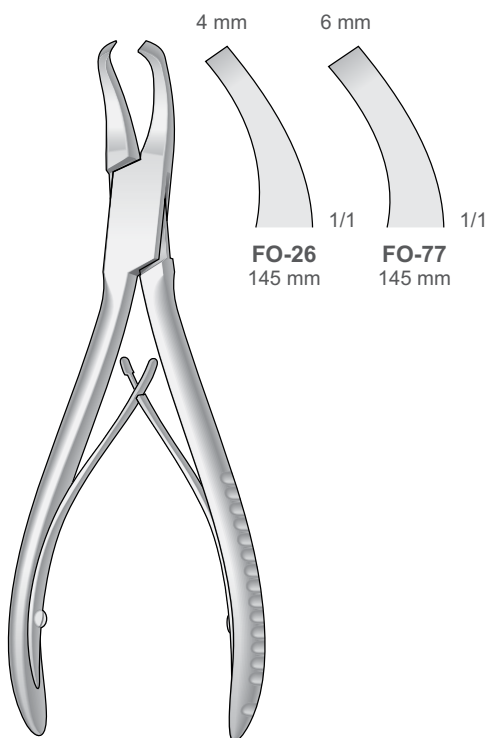

GARDNER
FO-26/FO-77
145 mm

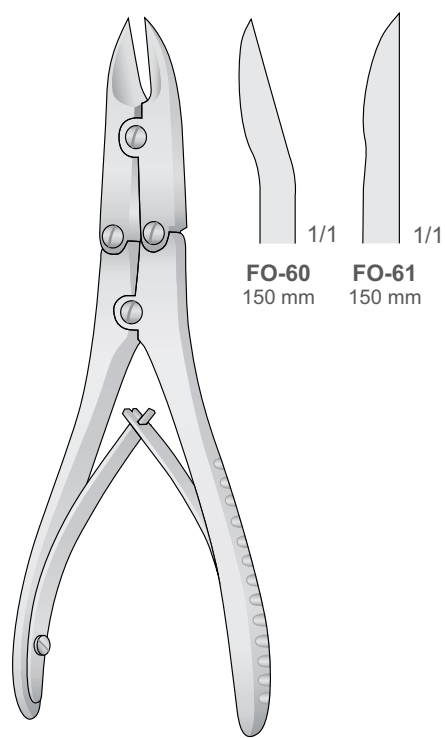

BÖHLER
FO-60/FO-61
150 mm

Bone cutting forceps

Knochensplitterzangen
Pinze ossivore
Pinzas cortantes para huesos
Pincas coupantes à os

Periosteals / Currettes / Bone

Periost / Küretten / Knochen
Périosteales / Currettes / Os
Periostali / Curette / Osso
Nadkostnitsy / Kyuretki / Kost'

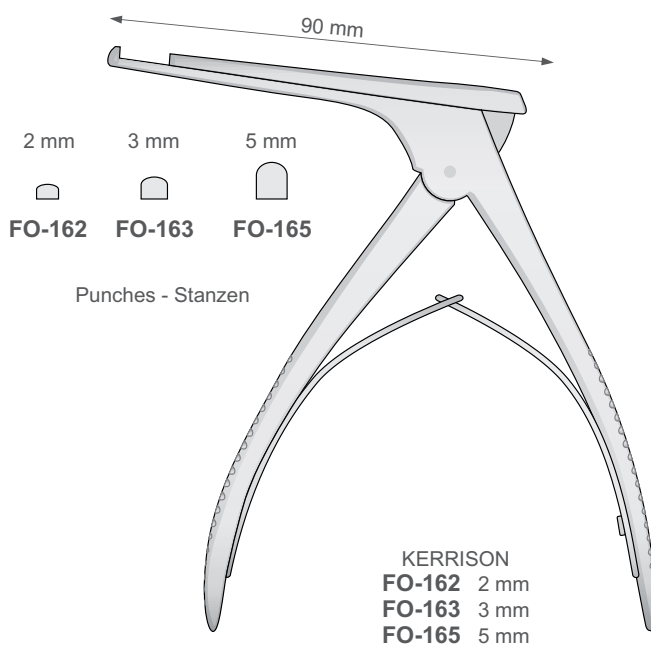

Bone cutting forceps
for opening the Sinus
Strumento tagliente per
aumentare il volume del seno

65 mm

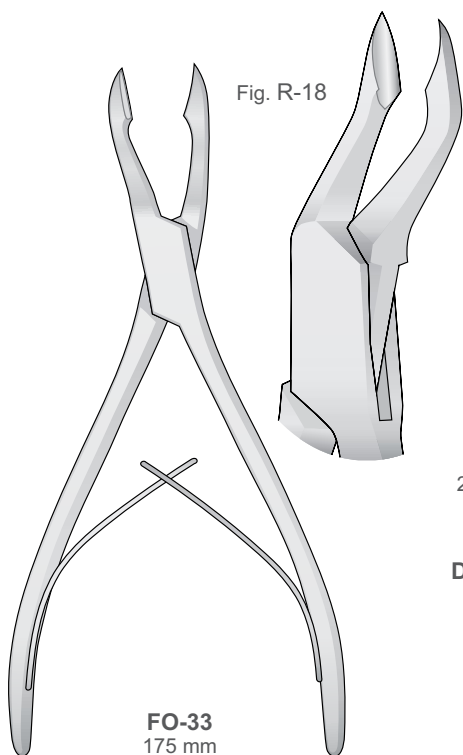
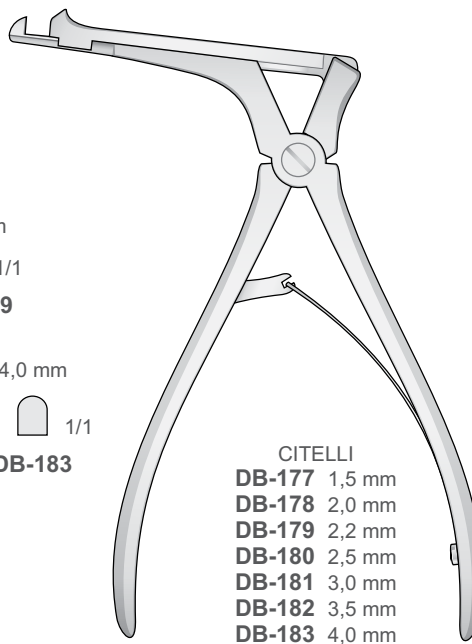

1,5 mm 2,0 mm 2,2 mm

1/1 1/1 1/1

DB-177 DB-178 DB-179

2,5 mm 3,0 mm 3,5 mm 4,0 mm

1/1 1/1 1/1 1/1

DB-180 DB-181 DB-182 DB-183



**PERIODONTICS
ENDODONTICS
RESTORATION**

Explorers - Sickle Probes

Zahnsonden
Esploratori - Sonde falce
Sondas exploradoras
Sondes exploratrices

Periodontics / Endodontics / Restoration

Parodontologie / Endodontie / Restauration
Parodontie / Endodontie / Restauration
Parodontologia / Endonzia / Restauro
Parodontologiya / Endodontiya / Restavratsiya

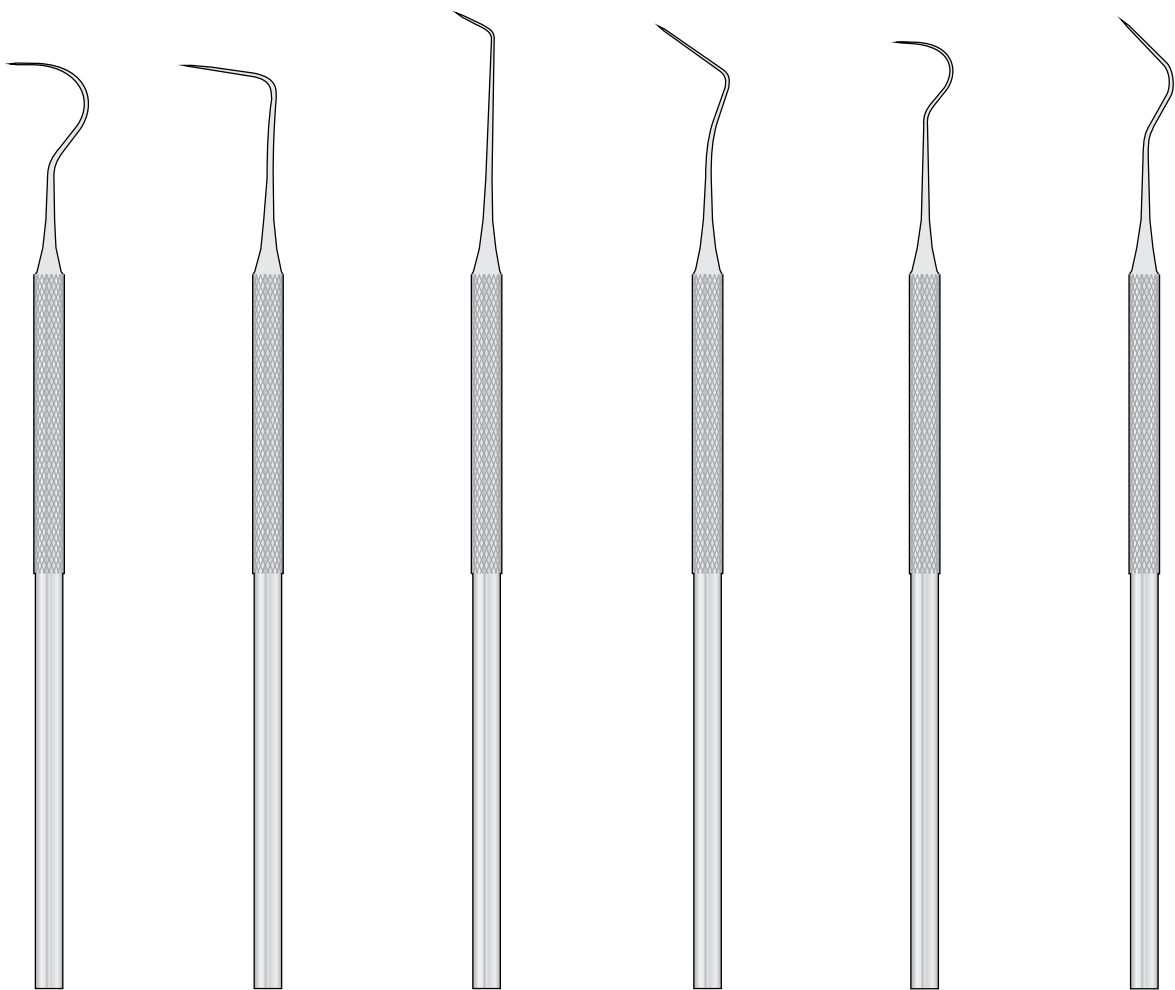

SO-1
Fig. 23

SO-2
Fig. 11

SO-3
Fig. 6

SO-4
Fig. 9

SO-5
Fig. 2

SO-6
Fig. 10

Explorers - Sickle Probes

Zahnsonden
Esploratori - Sonde falce
Sondas exploradoras
Sondes exploratrices

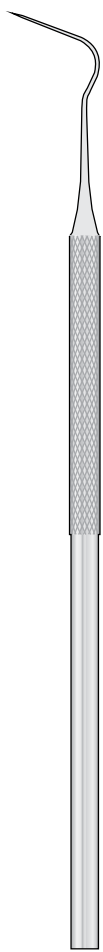

SO-7
Fig. 12

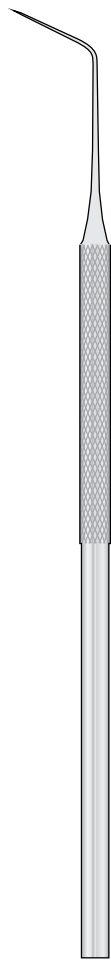

SO-8
Fig. 6A



SO-9
Fig. 8A

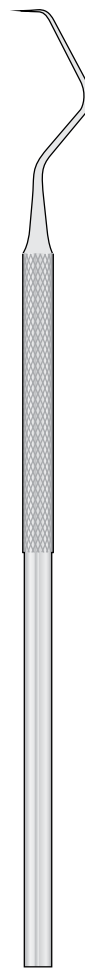

SO-10
Fig. 17A



SO-11
Fig. 3A



SO-12
Fig. 3

Periodontal Probes

Parodontometer
Sonde parodontali
Sondas parodontales
Sondes parodontales

Periodontics / Endodontics / Restoration

Parodontologie / Endodontie / Restauration
Parodontie / Endodontie / Restauration
Parodontologia / Endodonzia / Restauo
Parodontologiya / Endodontiya / Restavratsiya

Do not use Ultrasonic Cleaning
Verwenden Sie keine Ultraschall-Reinigung
Ne pas utiliser nettoyage à ultrasons
No usar limpieza ultrasónica
Non usare lavatrici ad ultrasuoni



Do not use metal brushes
Keine Drahtbürste verwenden
Ne pas utiliser de brosses métalliques
No utilizar cepillos metálicos
Non utilizzare spazzole metalliche

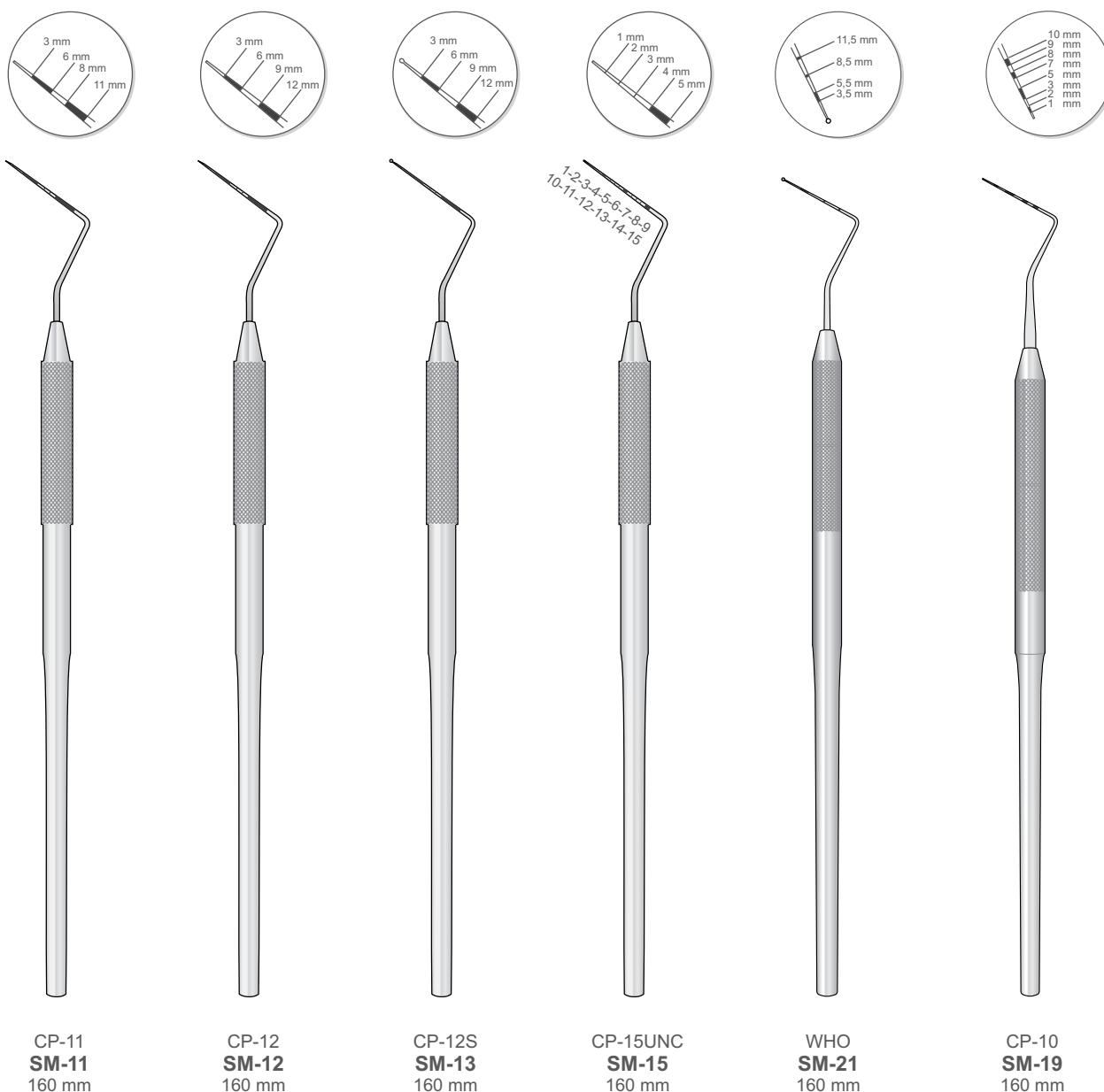

Periodontal Probes

Parodontometer
 Sonde parodontali
 Sondas parodontales
 Sondes parodontales

Double-ended Explorer
 Doppelendiger Zahnsonden
 Sonde exploratrice double
 Sonda exploradora doble
 Sonda falce doppia



11/12 ODU
SO-20
 165 mm

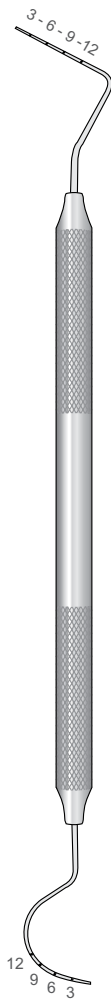

CATTONI
 UT3/4
SM-20
 165 mm

3 - 6 - 9 - 12

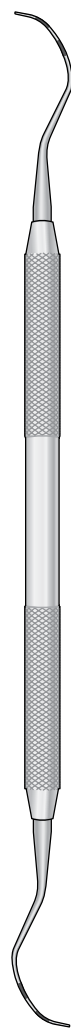

12 - 9 - 6 - 3
 NABERS
 2QN
SM-22
 175 mm

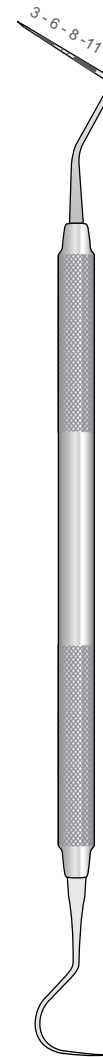
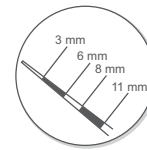

WILLIAMS
 23 CP-11
EX-11
 165 mm

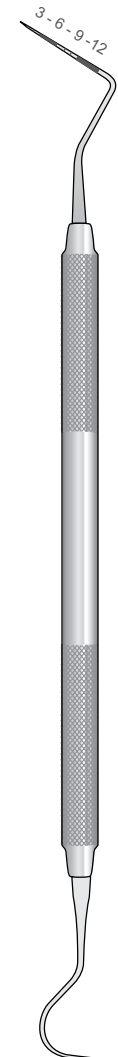

WILLIAMS
 23 CP-12
EX-12
 165 mm

Periodontal Probes

Parodontometer
Sonde parodontali
Sondas parodontales
Sondes parodontales

Periodontics / Endodontics / Restoration

Parodontologie / Endodontie / Restauration
Parodontie / Endodontie / Restauration
Parodontologia / Endodonzia / Restauro
Parodontologiya / Endodontiya / Restavratsiya

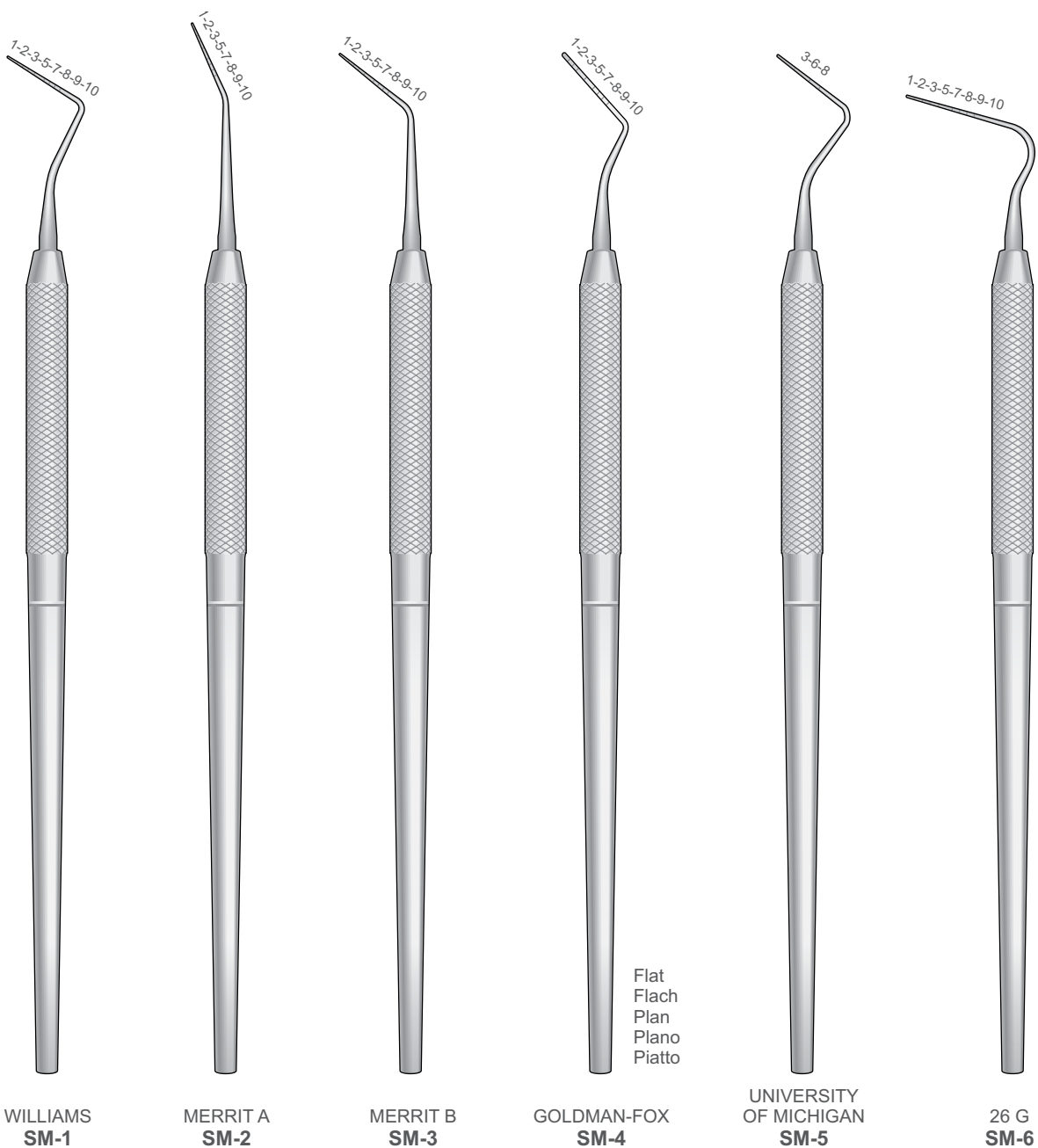

Endodontic Instruments

Instrumente für Endodontie

Strumenti per Endodonzia

Instrumentos para Endodoncia

Instrumentos pour Endodontie

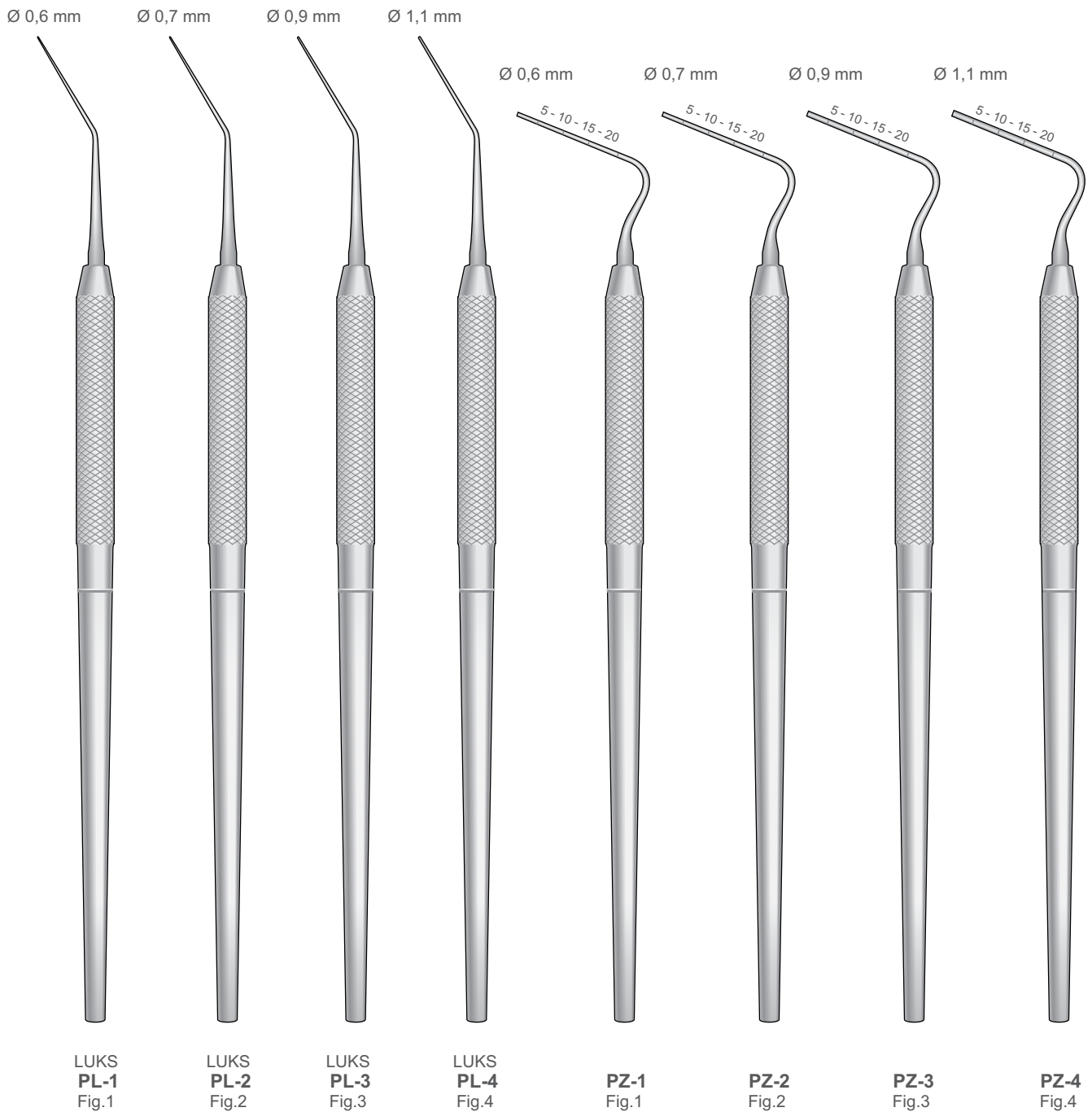

Endodontic Instruments

Instrumente für Endodontie
Strumenti per Endonzia
Instrumentos para Endoncia
Instruments pour Endodontie

Periodontics / Endodontics / Restoration

Parodontologie / Endodontie / Restauration
Parodontie / Endodontie / Restauration
Parodontologia / Endonzia / Restauro
Parodontologiya / Endodontiya / Restavratsiya

Spreaders

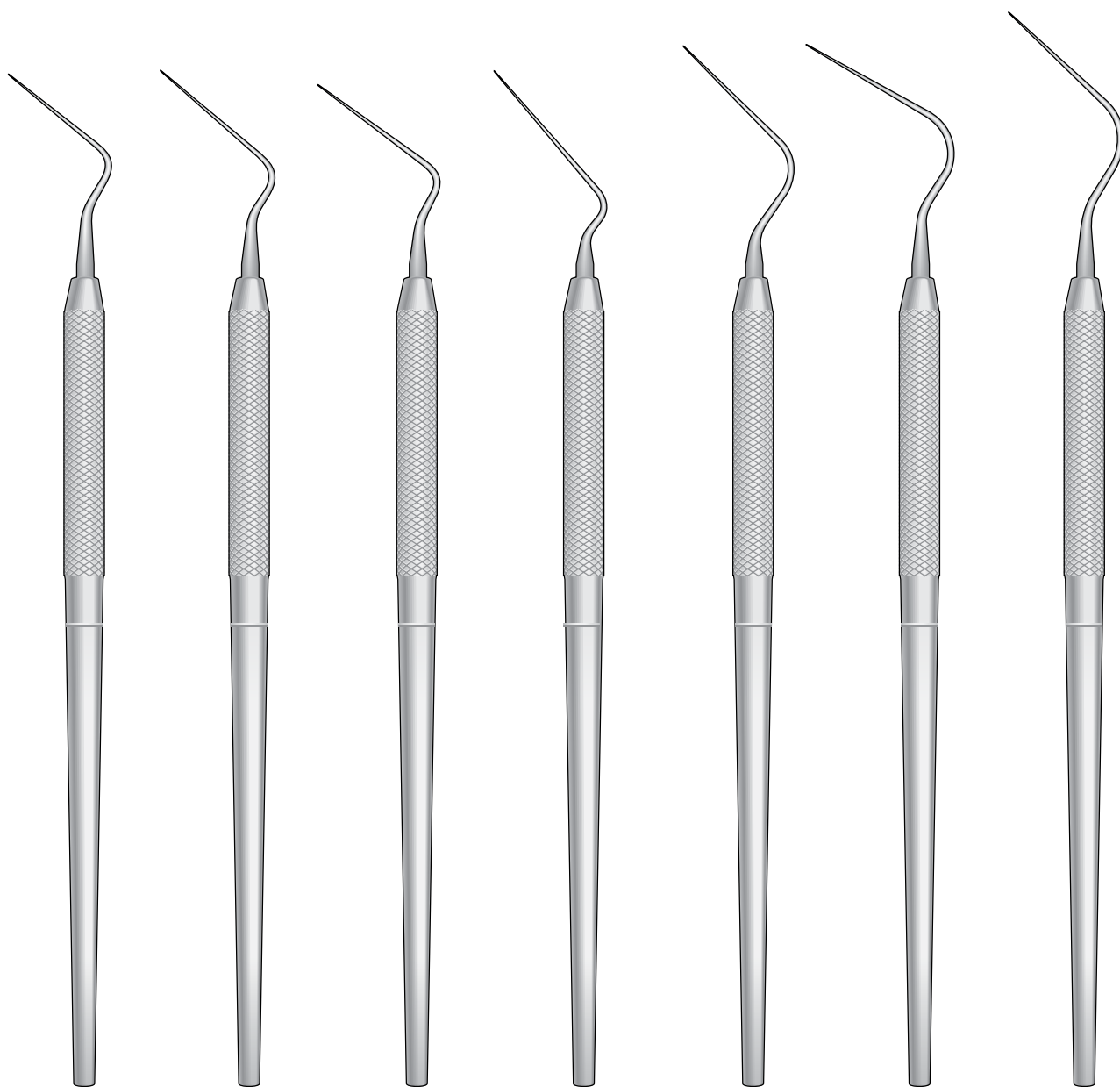

SP-1
Fig.1S

SP-2
Fig.2S

SP-3
Fig.D11

SP-4
Fig.MA57

SP-5
Fig.0

SP-6
Fig.00

SP-7
Fig.3

Cotton Applicators

Watteträger
Porta cotone
Portaalgodón
Applicateur de coton

Tamponstopfer
Gauze Packers
Porta tamponi
Portatampones
Porte tampons

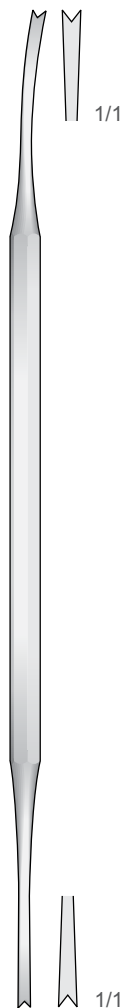

LUNIATSCHEK
PF-6
170 mm

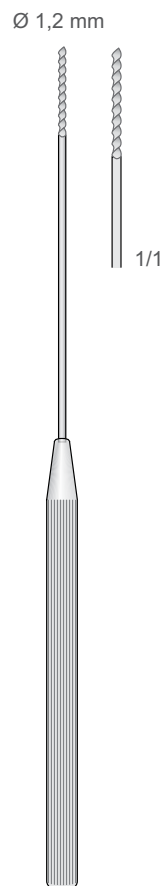

UNIVERSAL
PF-40
140 mm

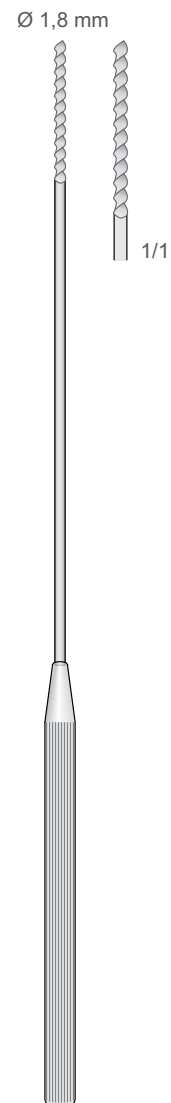

UNIVERSAL
PF-41
180 mm

Mirrors and handles

Mundspiegel und Griffe
Specchietti e manici
Espejos y mangos
Miroirs et manches

Periodontics / Endodontics / Restoration

Parodontologie / Endodontie / Restauration
Parodontie / Endodontie / Restauration
Parodontologia / Endodonzia / Restauro
Parodontologiya / Endodontiya / Restavratsiya

DOUBLE SIDED FRONT SURFACE RHODIUM MIRROR

Stainless steel - Rhodium coating

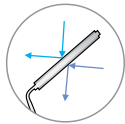

Reflecting surface is on **FRONT** of the glass.
Clear image. No distortion. No double/ghost image.

Rhodium coating for scratch resistance.

Enhanced indirect vision & illumination of dark areas.

Ergonomic & stream-lined design for less bulk.

+Visibility in any position: **2 opposite reflective faces**

(no need to turn the mirror to change from right to left).

Smoothly finished & retractor shaft design for patient comfort.

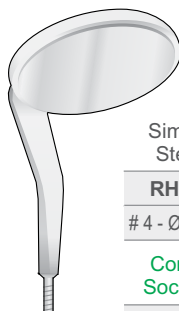

Simple Stem

RH-14

4 - Ø 22mm

Cone Socket

RH-15A

5 - Ø 24mm

Box of 6

FRONT SURFACE RHODIUM MIRRORS

Stainless steel - Rhodium coating

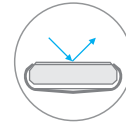

Reflecting surface is on **FRONT** of the glass.
Clear image. No distortion. No double/ghost image.

Rhodium coating for scratch resistance.

Enhanced indirect vision & illumination of dark areas.

Used for retraction of lips, cheeks and tongue.

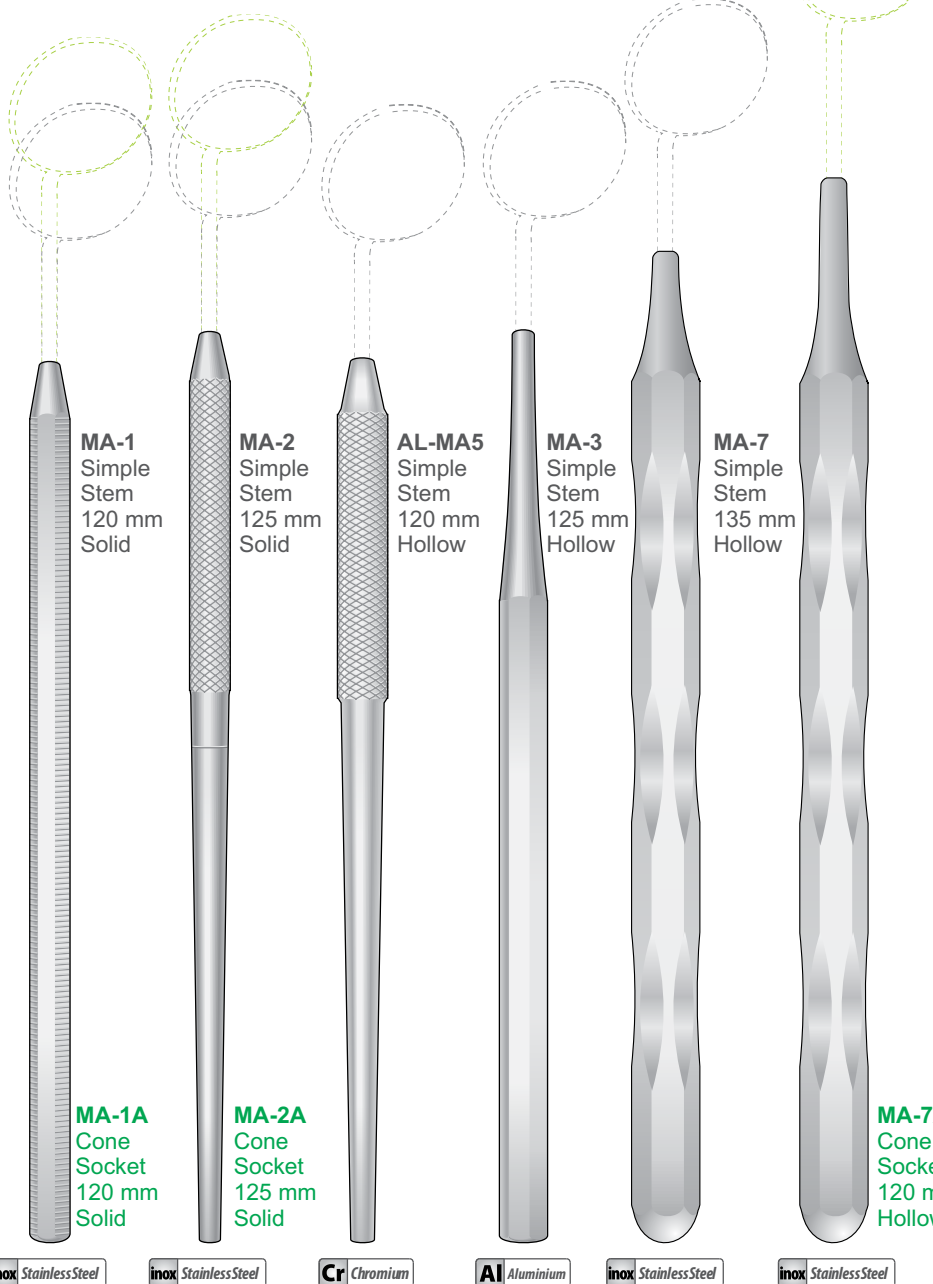

MA-1
Simple Stem
120 mm
Solid

MA-2
Simple Stem
125 mm
Solid

AL-MA5
Simple Stem
120 mm
Hollow

MA-3
Simple Stem
125 mm
Hollow

MA-7
Simple Stem
135 mm
Hollow

MA-1A
Cone Socket
120 mm
Solid

MA-2A
Cone Socket
125 mm
Solid

MA-7A
Cone Socket
120 mm
Hollow

inox StainlessSteel

inox StainlessSteel

Cr Chromium

Al Aluminium

inox StainlessSteel

inox StainlessSteel

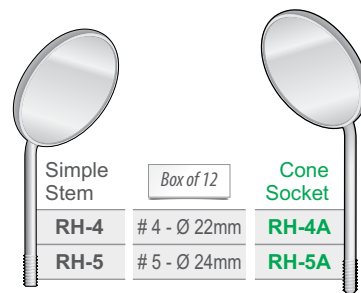

Simple Stem

RH-4

Box of 12

4 - Ø 22mm

RH-5

5 - Ø 24mm

Cone Socket

RH-4A

RH-5A

PLANE MIRRORS

Stainless steel - Aluminium coating



Re ecting surface is on **REAR** of the glass.
Aluminium coating. Good image quality.
Flat mirror produce double/ghost image.

Low-cost.

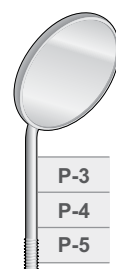

Simple Stem

Box of 12

P-3

3 - Ø 18mm

P-4

4 - Ø 22mm

P-5

5 - Ø 24mm

Concave with enlarging effect



Simple Stem

Box of 12

G-3

3 - Ø 18mm

G-4

4 - Ø 22mm

G-5

5 - Ø 24mm

Mirrors and handles

Mundspiegel und Griffe
Specchietti e manici
Espejos y mangos
Miroirs et manches

Spiegeldurchmesser - Diameter of mirrors
Diametro dello specchio - Diamètre des miroirs
Diámetro de los espejos

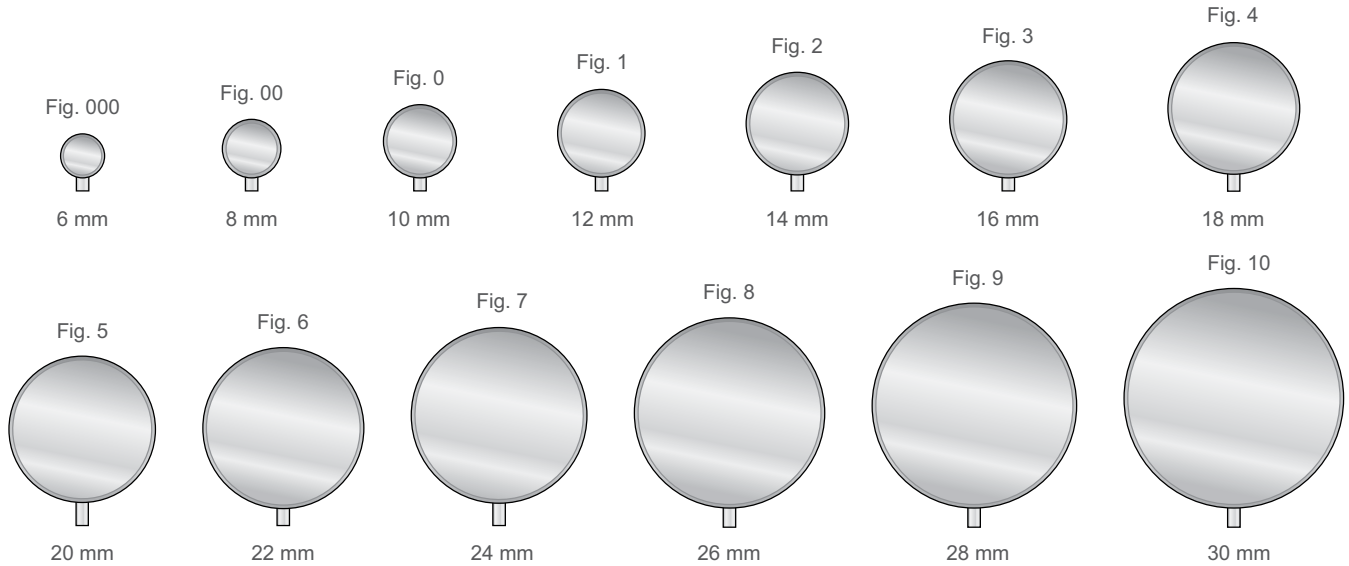

Inox

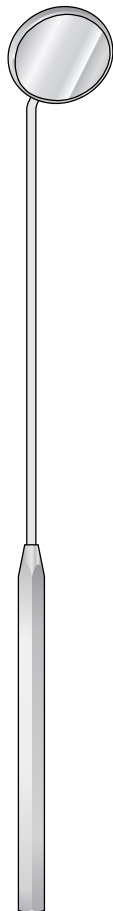

Kehlkopfspiegel mit
Sechskantgriff
Laryngeal mirrors
with hexagonal handle
Specchietto laringeo
con manico esagonale
Espejo laringeo
con mango hexagonal
Miroirs laryngiens
avec manche hexagonal

G-8 Fig. 00
G-10 Fig. 0
G-12 Fig. 1
G-14 Fig. 2
G-16 Fig. 3
G-18 Fig. 4
G-20 Fig. 5
G-22 Fig. 6
G-24 Fig. 7
G-26 Fig. 8
G-28 Fig. 9
G-30 Fig. 10

G-8/G-30
180 mm

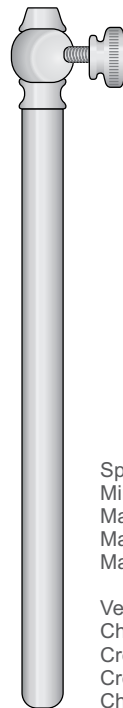

Spiegelgriff
Mirrors handle
Manico per specchietti
Mango para espejos
Manche à miroir

Verchromt
Chromium
Cromato
Cromado
Chromé

MA-6
120 mm

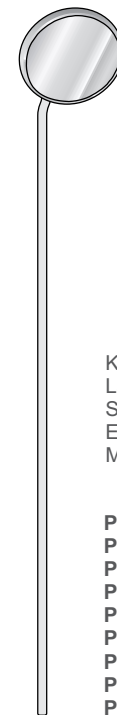

Kehlkopfspiegel
Laryngeal mirrors
Specchietto laringeo
Espejos laryngios
Miroirs laryngiens

P-000 Fig. 000
P-00 Fig. 00
P-0 Fig. 0
P-01 Fig. 1
P-02 Fig. 2
P-03 Fig. 3
P-04 Fig. 4
P-05 Fig. 5
P-06 Fig. 6

P-000/P-06
120 mm

Dental Syringes

Dental-Spritzen
Siringhe dentali
Jeringas dentales
Seringues dentaires

Periodontics / Endodontics / Restoration

Parodontologie / Endodontie / Restauration
Parodontie / Endodontie / Restauration
Parodontologia / Endodonzia / Restauro
Parodontologiya / Endodontiya / Restavratsiya

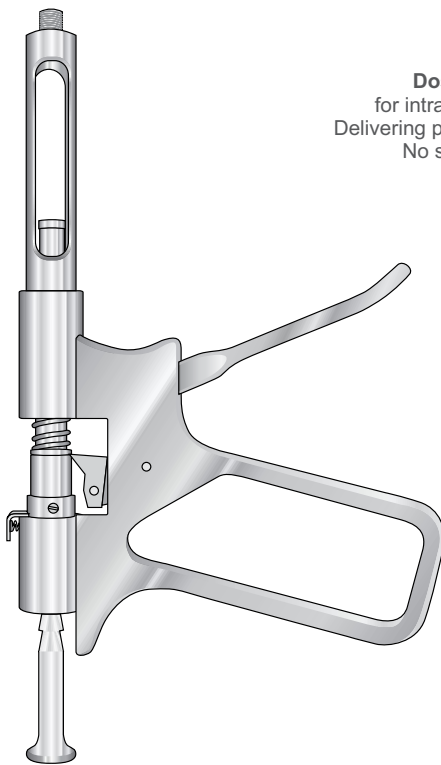

Dosing Lever Syringe
for intraligamentary anesthesia.
Delivering precisely 0.2 ml of anesthetic.
No soft-tissue numbness.

- SD-7**
Imperial Tip
1.8 ml
- SD-7M**
Metric Thread
1.8 ml
- SD-9NA**
Imperial Tip
1.8 ml
(Sold only in North America)

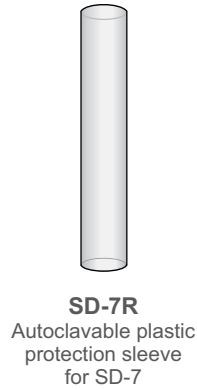

SD-7R
Autoclavable plastic protection sleeve for SD-7

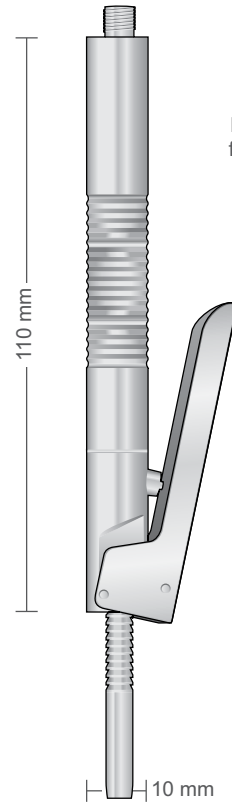

Pen-style Syringe
for intraligamentary anesthesia

- SD-20**
Imperial Tip
1.8 ml
- SD-20M**
Metric Thread
1.8 ml

Aspirating Anesthetic Syringe

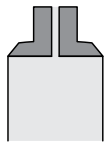

Aspirating syringes feature a blunt harpoon rod.

Lightweight and Ergonomic.

High quality stainless steel.

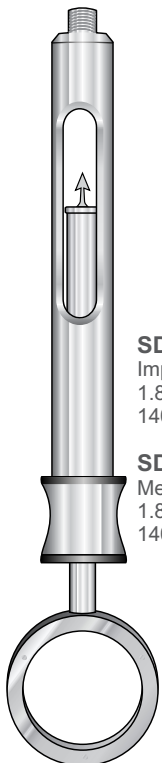

SD-8
Imperial Tip
1.8 ml
140mm

SD-8M
Metric Thread
1.8 ml
140mm

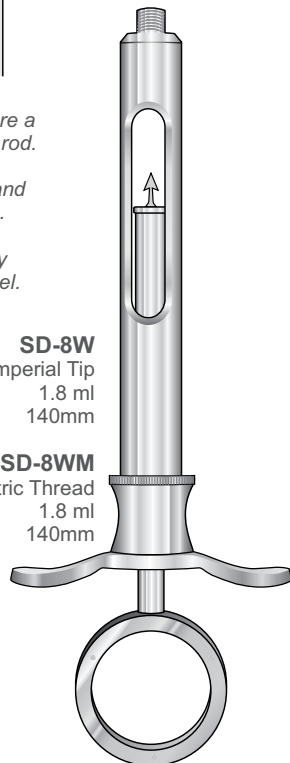

SD-8W
Imperial Tip
1.8 ml
140mm

SD-8WM
Metric Thread
1.8 ml
140mm

Aspirating and Self Aspirating Anesthetic Syringe

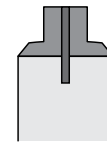

Self-aspirating mechanism allows to aspirate by means of counter pressure.

Lightweight and Ergonomic.

High quality stainless steel.

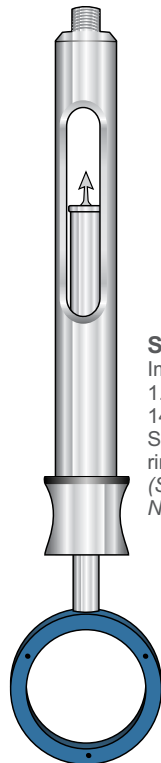

SD-8NA
Imperial Tip
1.8 ml
140mm
Silicone covered ring handle
(Sold only in North America)

Silicone covered ring handle

Self Aspirating Anesthetic Syringe

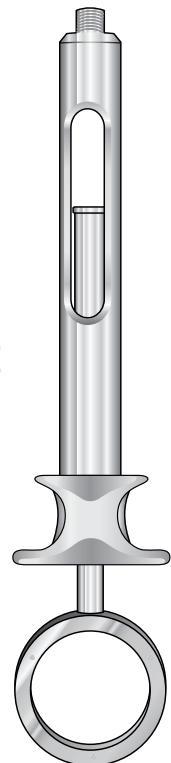

SD-88
Imperial Tip
1.8 ml
140mm

SD-88M
Metric Thread
1.8 ml
140mm

Dental Syringes

Dental-Spritzen
Siringhe dentali
Jeringas dentales
Seringues dentaires

Zylinder-Ampullen Spritzen
Cartridge Syringes
Siringhe per tubofiale
Jeringas de ampollas
Seringues d'ampoules

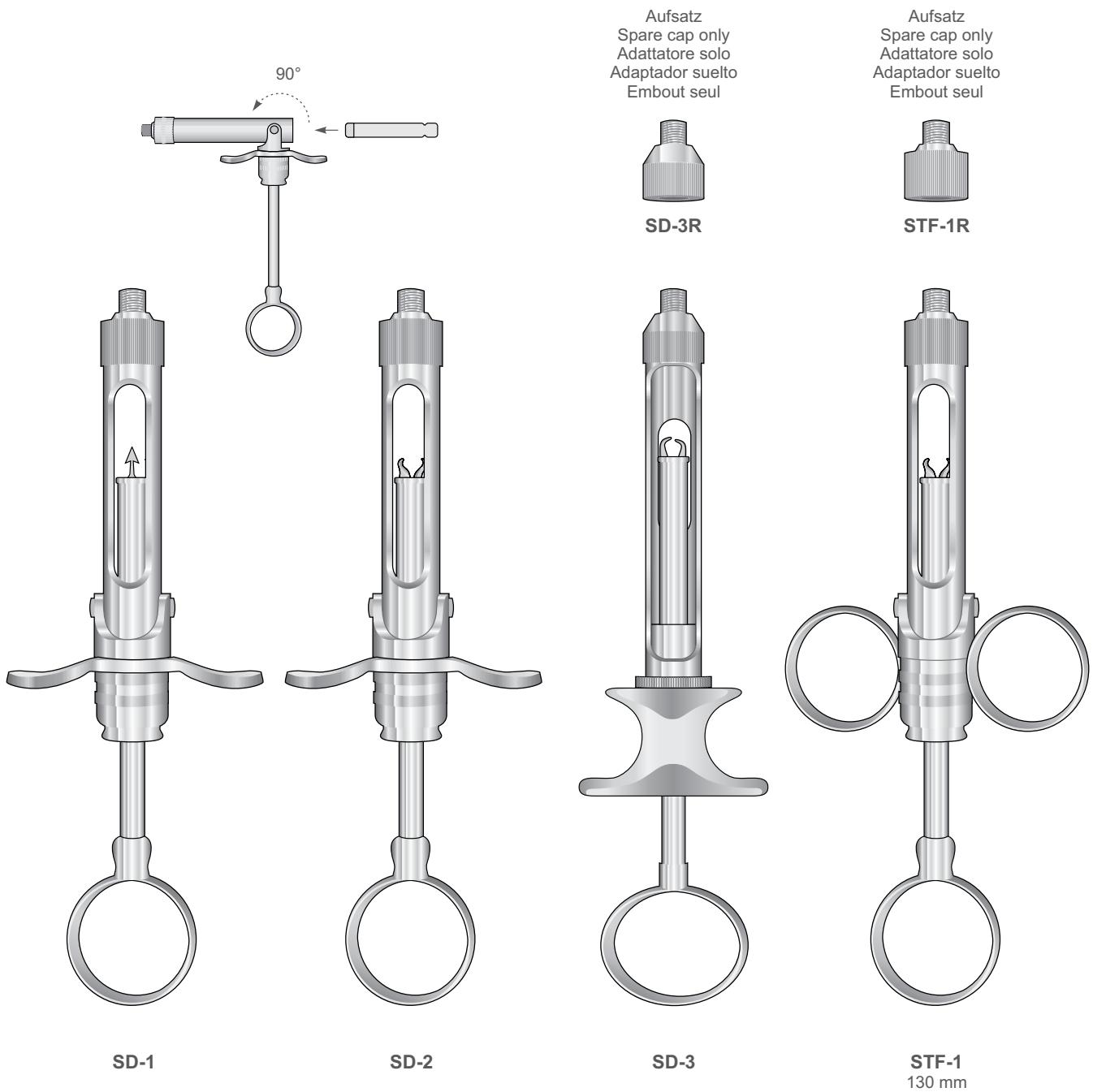

Curettes

Küretten
Curette
Curetas
Curettes

Periodontics / Endodontics / Restoration

Parodontologie / Endodontie / Restauration
Parodontie / Endodontie / Restauration
Parodontologia / Endodonzia / Restauo
Parodontologiya / Endodontiya / Restavratsiya

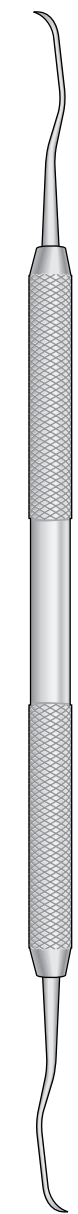

GRACEY
CU-1/2

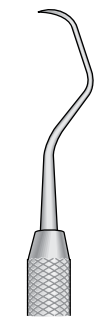

GRACEY
CU-3/4



GRACEY
CU-5/6



GRACEY
CU-7/8



GRACEY
CU-9/10



GRACEY
CU-11/12



GRACEY
CU-13/14

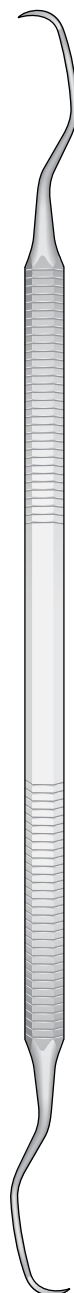

LANGER Fig. 1/2
COL-1/2



LANGER Fig. 3/4
COL-3/4



COLUMBIA
COL-2RL

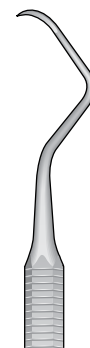

COLUMBIA
COL-4RL



COLUMBIA
COL-13/14

Scalers and Curettes

Scaler und Küretten

Scaler e Curette

Raspadores y Curetas

Détartreurs et Curettes

Elite
Stainless Steel

Balanced and ergonomic for great tactile working ability. Maintains long sharp edges.
Extra light hollow handle for optimum comfort (feather weight / round Ø 9 mm).

Curettes

- Universal Tip 90°
- Gracey Tip 70°

Cutting Edges

Scalers

- Curved Blade
- Tip 50°
- Straight Blade

Cutting Edges

Gracey Hygiene Chart

Anterior: 1/2, 3/4, 5/6 Buccal Lingual Surfaces: 7/8, 9/10 Mesial Surfaces Premolars, Molars: 11/12, 15/16 Distal Surfaces Premolars, Molars: 13/14, 17/18

Also available: **ET**: Extra-Thin (micro), **S**: Small (mini S) and **L**: Long (after S)

Ausgewogen und ergonomisch für eine gute Anwendbarkeit. Dauerhafte scharfe Ecken. Extra leichte Hohlgriffe für optimale Komfort (Federleicht).

Équilibrés et ergonomiques pour une plus grande habileté tactile. Bords tranchants durables. Manche extra léger et creux pour un confort optimal (poids plume).

Equilibrado y ergonómico para mayor una facilidad de táctil. Bordes afilados durables. Mango hueco ultra liviano para un confort óptimo (peso pluma).

Bilanciata ed ergonomiche per una maggiore facilità di lavoro. Bordi taglienti durevoli. Impugnatura cava, extra leggera, per un confort ottimale (peso piuma).



USG-1/2ET
Gracey
Curette 1/2ET

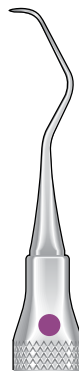

USG-3/4ET
Gracey
Curette 3/4ET



USG-5/6ET
Gracey
Curette 5/6ET



USG-7/8ET
Gracey
Curette 7/8ET



USG-9/10ET
Gracey
Curette 9/10ET



USG-11/12ET
Gracey
Curette 11/12ET



USG-13/14ET
Gracey
Curette 13/14ET



USG-15/16ET
Gracey
Curette 15/16ET

Scalers and Curettes

Scaler und Küretten
Scaler e Curette
Raspadores y Curetas
Détartreurs et Curettes

Periodontics / Endodontics / Restoration

Parodontologie / Endodontie / Restauration
Parodontie / Endodontie / Restauration
Parodontologia / Endodonzia / Restauro
Parodontologiya / Endodontiya / Restavratsiya

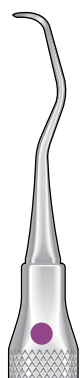

USG-1/2
Gracey
Curette 1/2



USG-3/4
Gracey
Curette 3/4



USG-5/6
Gracey
Curette 5/6



USG-7/8
Gracey
Curette 7/8



USG-9/10
Gracey
Curette 9/10



USG-11/12
Gracey
Curette 11/12



USG-13/14
Gracey
Curette 13/14



USG-1/2S
Gracey
Curette 1/2S



USG-3/4S
Gracey
Curette 3/4S



USG-5/6S
Gracey
Curette 5/6S



USG-7/8S
Gracey
Curette 7/8S



USG-9/10S
Gracey
Curette 9/10S



USG-11/12S
Gracey
Curette 11/12S



USG-13/14S
Gracey
Curette 13/14S



Scalers and Curettes

Scaler und Küretten
Scaler e Curette
Raspadores y Curetas
Déartreurs et Curettes

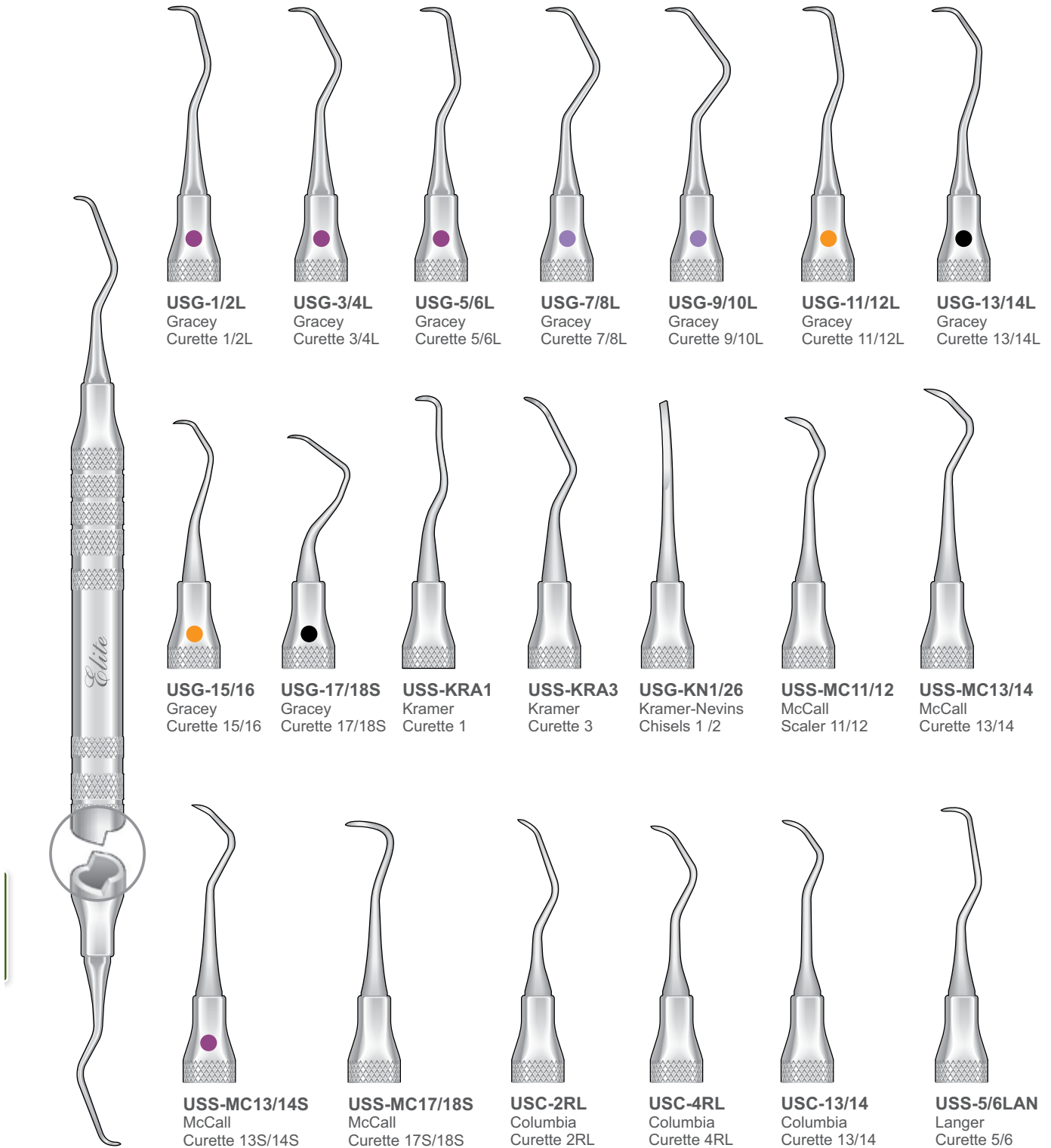

Scalers and Curettes

Scaler und Küretten
Scaler e Curette
Raspadores y Curetas
Détartreurs et Curettes

Periodontics / Endodontics / Restoration

Parodontologie / Endodontie / Restauration
Parodontie / Endodontie / Restauration
Parodontologia / Endodonzia / Restauro
Parodontologiya / Endodontiya / Restavratsiya



USS-NV0
Nevi
Scaler
Nv0



USS-NV11/12
Nevi
Scaler
NV11/12



USS-NV13/14
Nevi
Scaler
NV13/14



USS-T2/3
Taylor
Scaler 2/3



USS-204S
Scaler
204S



USS-H6/7
Scaler
H6/H7



USS-15/33
Towner-Jaquette
Scaler
U15/J33



USS-5/33
Jaquette
Scaler
H5/J33



USS-15/30
Towner-Jaquette
Scaler
U15/J30



USS-J14/15
Jaquette
Scaler
J14/15

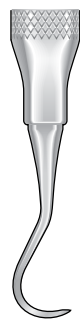

Scalers and Curettes

Scaler und Küretten

Scaler e Curette

Raspadores y Curetas

Détartreurs et Curettes

Curettes

Universal Tip 90°
Gracey Tip 70°
Cutting Edges

Elite
TITANIUM

Long lasting solid titanium tip. Designed for removing calculus on implants surfaces. Gold coloured handle for easy identification purposes so they won't be mixed up with standard stainless instruments (feather weight / round Ø 9mm).

Scalers

Curved Blade
Tip 90°
Straight Blade
Cutting Edges

Messivem Titan-Spitzen dass sie extrem widerstandsfähig und langlebig sind. Entwickelt für die Entfernung von Zahnbelag auf Implantat Oberflächen. Vergoldete Griffe für eine einfache Kennzeichnung damit sie von Standard Instrumenten unterschieden werden können (Federleicht).

Pointes en titane solide plus résistantes et durables. Développées pour l'enlèvement du tartre sur les implants en titane. Manche de couleur or pour une meilleure identification. Ceci permet de ne pas les confondre avec les instruments communs en acier inoxydable (poids plume).

Gracey Hygiene Chart

Anterior Posterior Molars Premolars (bicuspids) Canines (cuspid) Incisors

UPPER LOWER

Canines (cuspid) Premolars (bicuspids) Molars

Puntas de titanio sólido más resistentes y durables. Diseñado para eliminar el sarro en los implantes de titanio. Mango dorado para una mejor identificación, el cual evita la confusión con los instrumentos de acero inoxidable estándar (peso pluma).

Punte in titanio solido più resistente e durevole. Progettate per la rimozione di tartaro dalle superfici degli impianti. Manico color oro per un riconoscimento semplice e per evitare di essere confuse con i strumenti in acciaio (peso pluma).

● Anterior: 1/2, 3/4, 5/6 ● Buccal Lingual Surfaces: 7/8, 9/10 ● Mesial Surfaces Premolars, Molars: 11/12, 15/16 ● Distal Surfaces Premolars, Molars: 13/14, 17/18

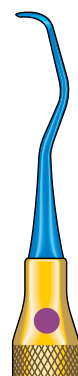

T-USG-1/2
Gracey
Curette 1/2

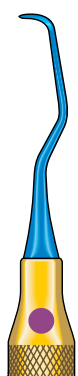

T-USG-5/6
Gracey
Curette 5/6

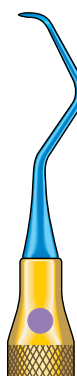

T-USG-7/8
Gracey
Curette 7/8

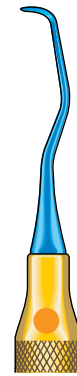

T-USG-11/12
Gracey
Curette 11/12



T-USG-13/14
Gracey
Curette 13/14



T-USS-B5/6
Barnhart
Curette 5/6

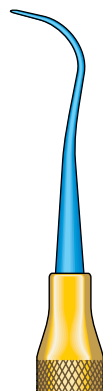

T-USS-YG7/8
Younger-Good
Curette YG 7/8



T-USS-204S
Scaler 204S

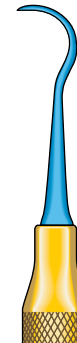

T-USS-G6/7
Scaler G6/G7

⚠ Use a dedicated sharpening stone for Titanium Scalers & Curettes.

Curettes - Files

Curette - Lima
 Curetasc - Lima
 Curettes - Limes
 Curettes - Limes

Periodontics / Endodontics / Restoration

Parodontologie / Endodontie / Restauration
 Parodontie / Endodontie / Restauration
 Parodontologia / Endodonzia / Restauro
 Parodontologiya / Endodontiya / Restavratsiya

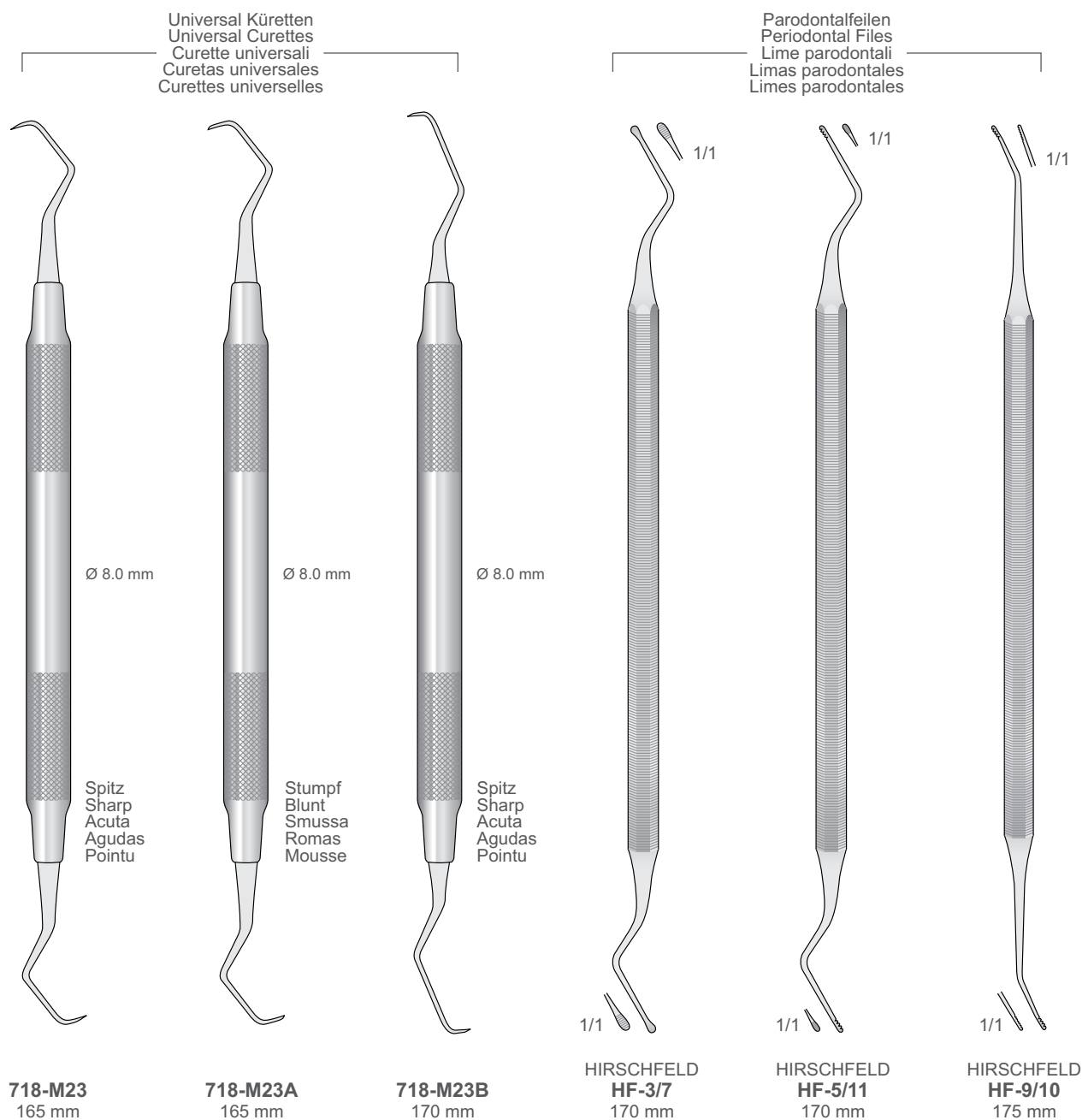

Scalers

Scaler
Ablatori di tartaro
Limpiadores
Détartreurs

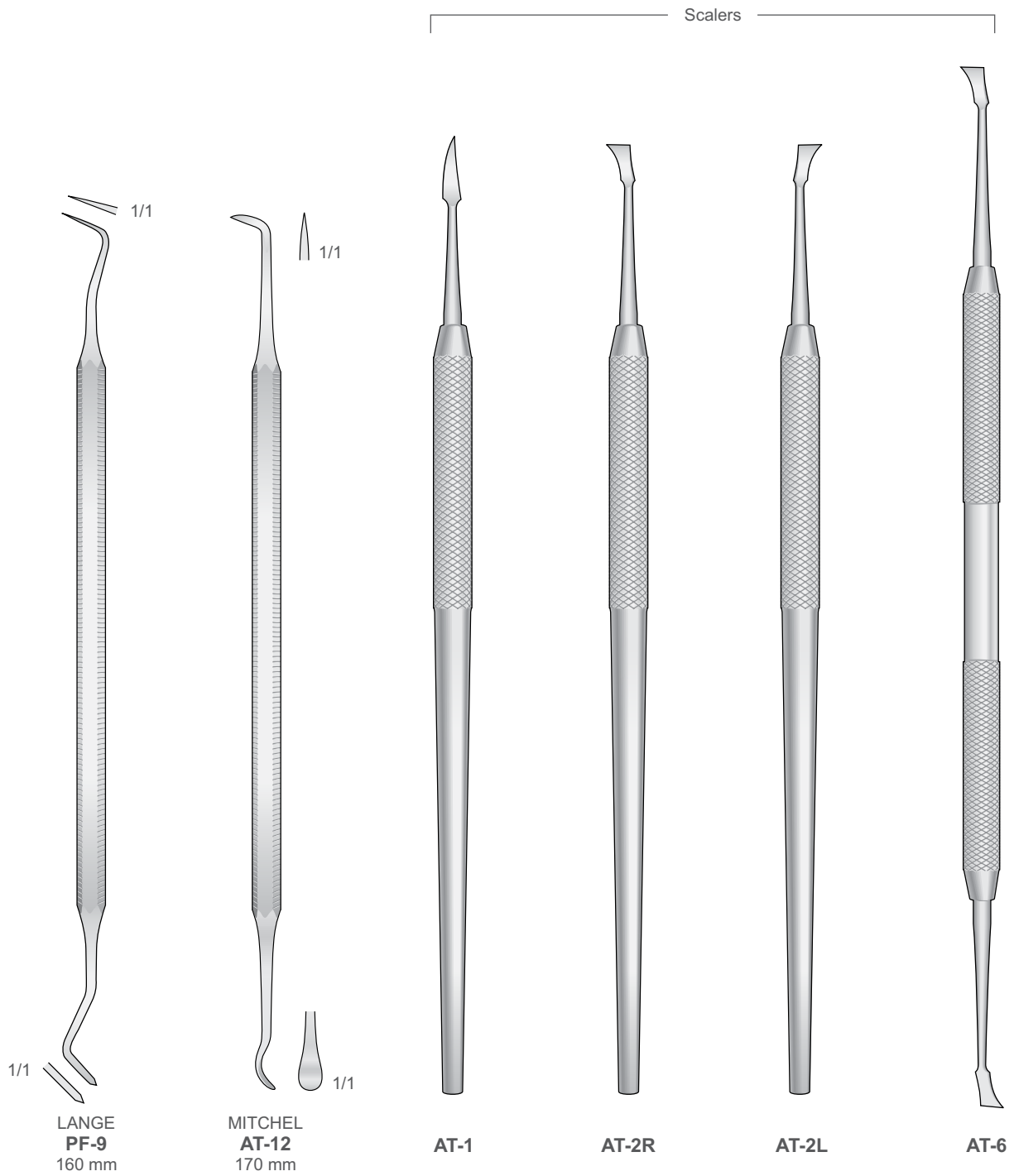

Amalgam gun for retrograde

Amalgampistole für retrograde
Siringhe portamalgame retrogradi
Portaamalgama para retrógradas
Porte-amalgame pour rétrogrades

Periodontics / Endodontics / Restoration

Parodontologie / Endodontie / Restauration
Parodontie / Endodontie / Restauration
Parodontologia / Endodonzia / Restauro
Parodontologiya / Endodontiya / Restavratsiya

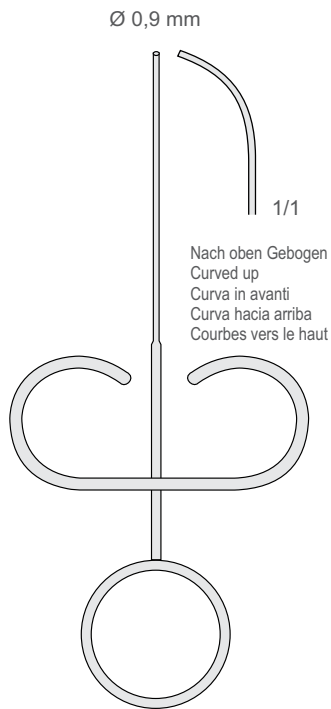

SS-51
130 mm

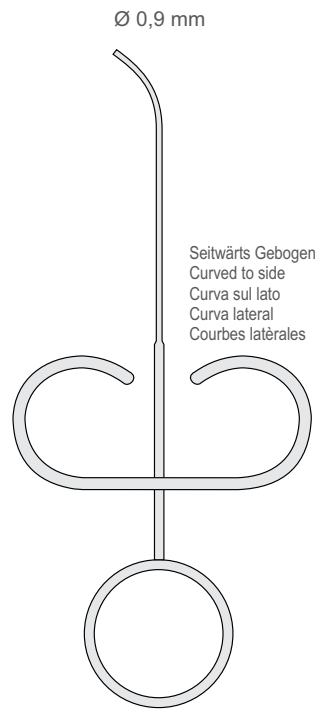

SS-55
130 mm

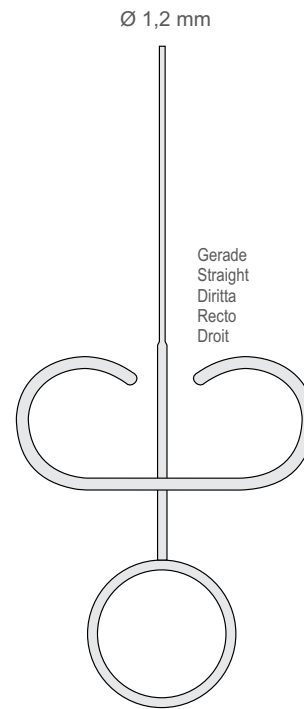

SS-54
130 mm

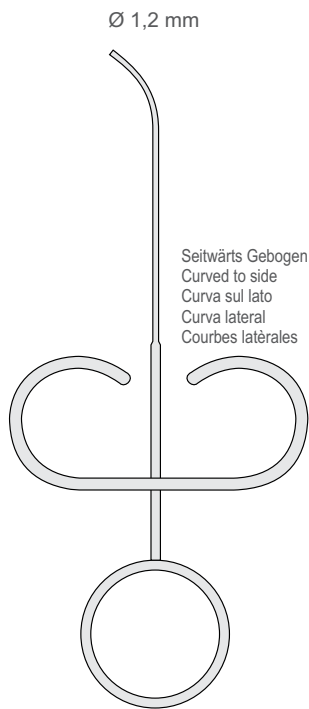

SS-56
130 mm

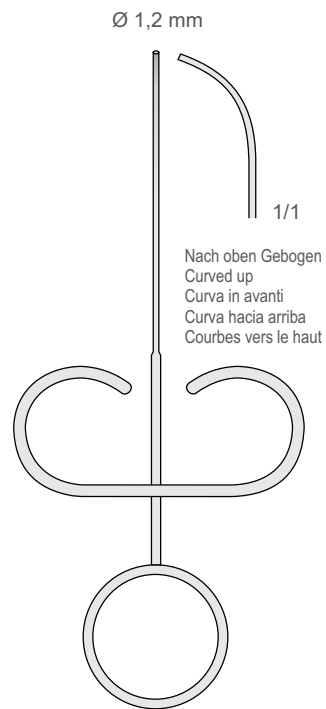

SS-58
130 mm

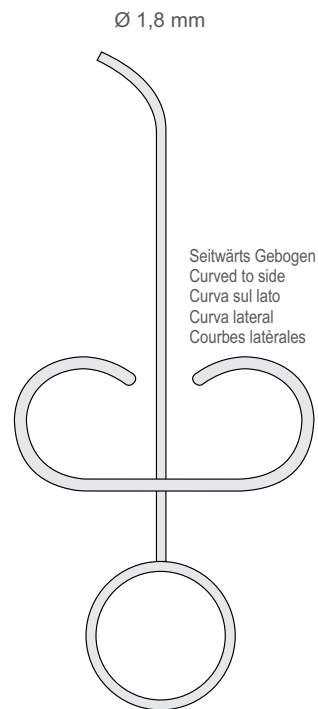

SS-50
130 mm

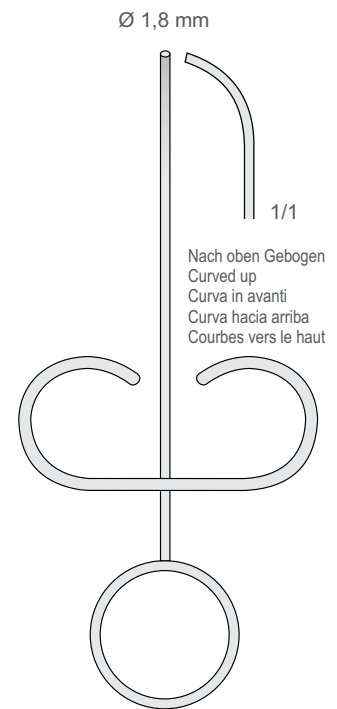

SS-52
130 mm

Amalgam Carriers

Amalgamträger
Porta amalgama
Porta-amalgamas
Porte-amalgames

inox StainlessSteel

Amalgambecher
Amalgam Well
Mortaino per amalgama
Vaso para amalgama
Gobelet pour amalgame



Knochenschale
Bone Well
Bacinella per osso
Cubeta para hueso
Cuvette à os

SS-65

Ø 35 x 35mm
depht 15 mm
5cc - 0.17oz

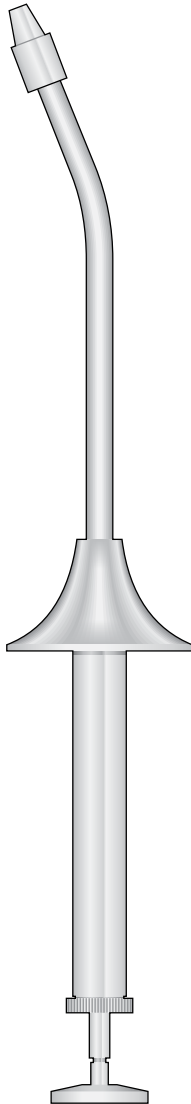

SS-15

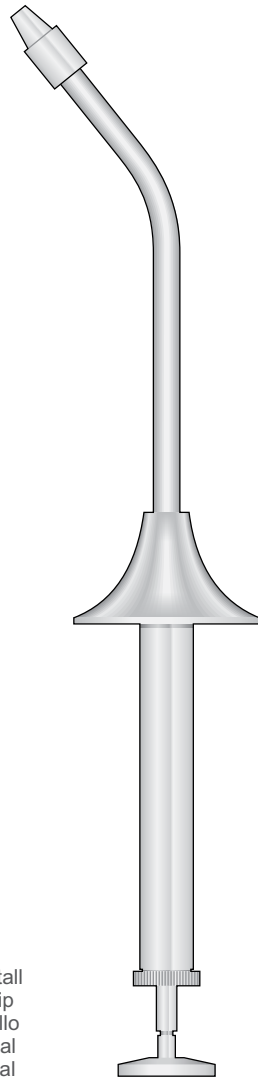

SS-16

Aus Metall
Metal tip
In metallo
De metal
En métal

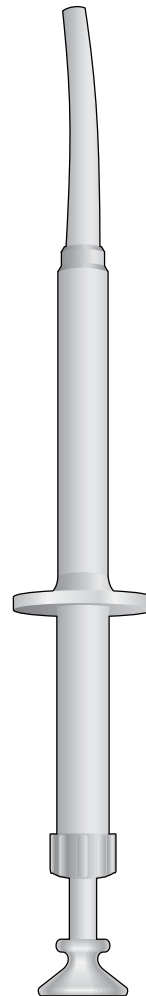

SS-41
170 mm

Autoclavable
Aus Kunststoff
Plastic tip
In plastica
De plàstico
En plastique

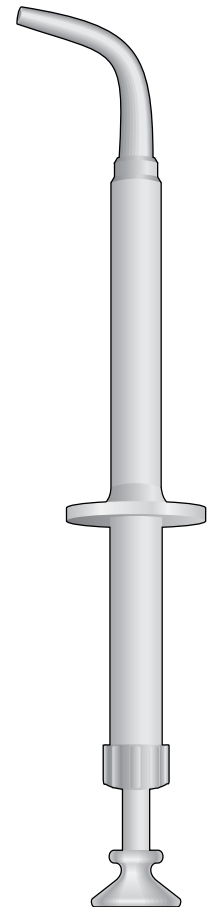

SS-42
160 mm

Composite Instruments

Kompositinstrumente
Strumenti per composito
Instrumentos para composites
Instruments pour composites

Periodontics / Endodontics / Restoration

Parodontologie / Endodontie / Restauration
Parodontie / Endodontie / Restauration
Parodontologia / Endodonzia / Restauro
Parodontologiya / Endodontiya / Restavratsiya



Fig. FE1

Fig. FE2

Fig. FE3

Fig. FE4

Fig. FE5

Fig. FE6

Fig. GO1

Fig. GO2

Fig. GO3

Fig. GO4



FELT
OT-1

FELT
OT-2

FELT
OT-3

FELT
OT-4

FELT
OT-5

FELT
OT-6

GOLDSTEIN
OT-7

GOLDSTEIN
OT-8

GOLDSTEIN
OT-9

GOLDSTEIN
OT-10

Composite Instruments

Kompositinstrumente
Strumenti per composito
Instrumentos para composites
Instruments pour composites



Titanium-coated
Titan-beschichtet
Recouvrement en Titane
Recubrimiento de Titanio
Ricoperto in Titanio

Fig. CP1
1,5 mm

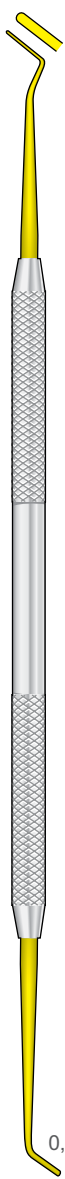

OT-11

Fig. CP2
2,0 mm



OT-12

Fig. CP3
2,0 mm

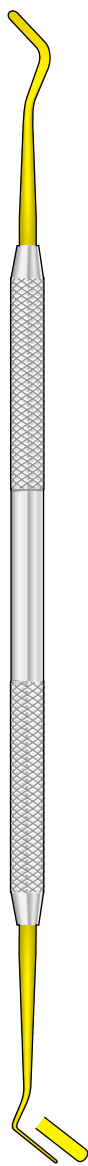

OT-13

Fig. CP4
2,5 mm

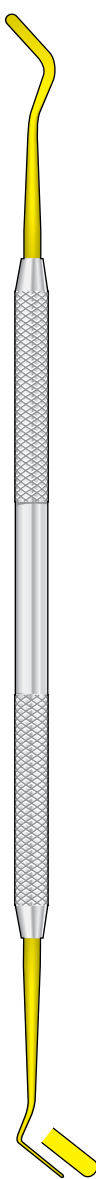

OT-14

Fig. CP5



OT-15

Fig. CP6

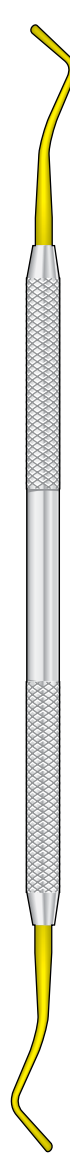

OT-16

Composite Instruments

Kompositinstrumente
Strumenti per composito
Instrumentos para composites
Instruments pour composites

Periodontics / Endodontics / Restoration

Parodontologie / Endodontie / Restauration
Parodontie / Endodontie / Restauration
Parodontologia / Endodonzia / Restauro
Parodontologiya / Endodontiya / Restavratsiya



FELT

GOLDSTEIN

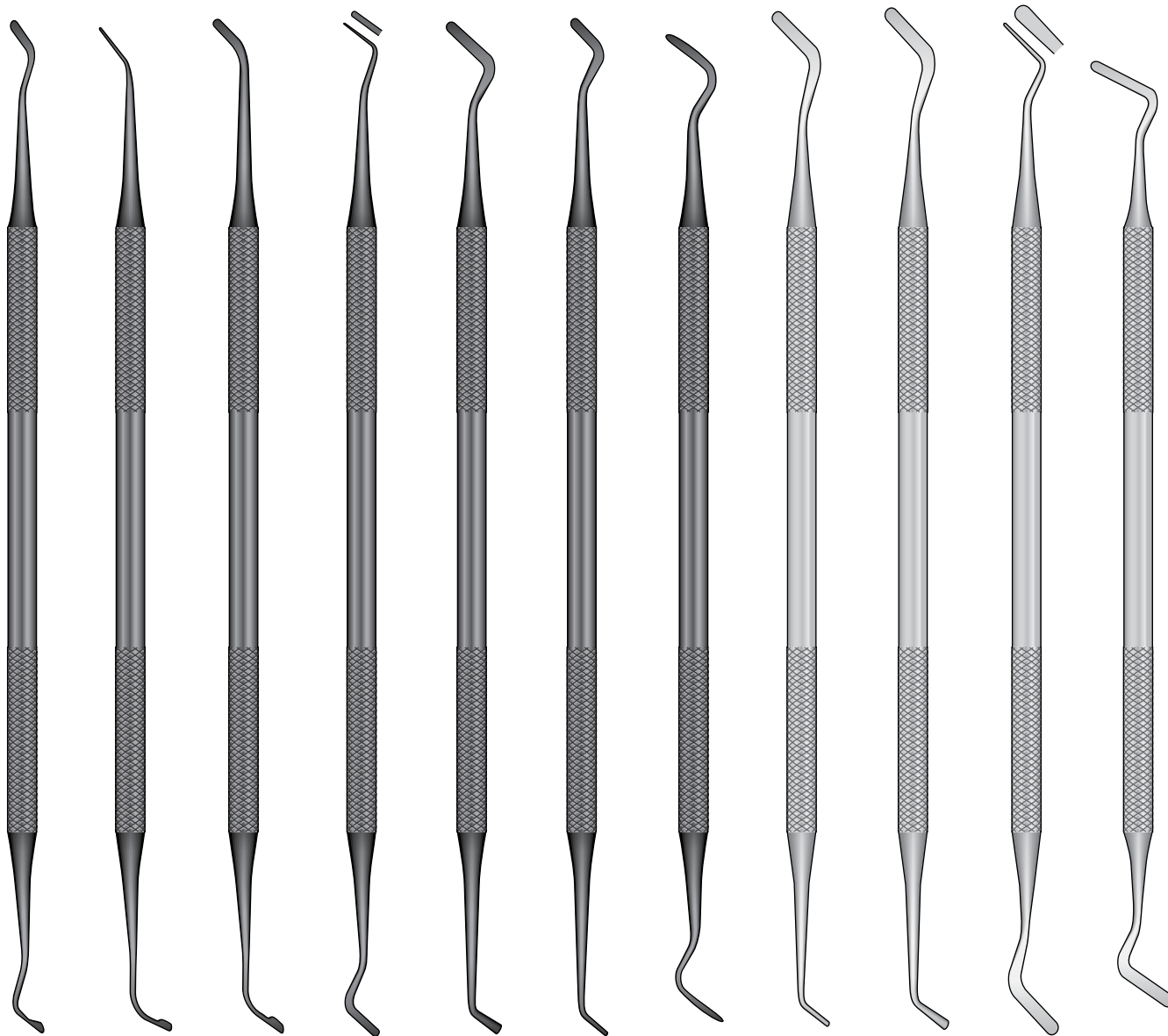

FE-1

FE-2

FE-3

FE-4

FE-5

FE-6

FE-4/5

GO-1

GO-2

GO-3

GO-4

Cement Spatulas

Zementspatel

Spatole per cemento

Espátulas para cemento

Spatules à ciment

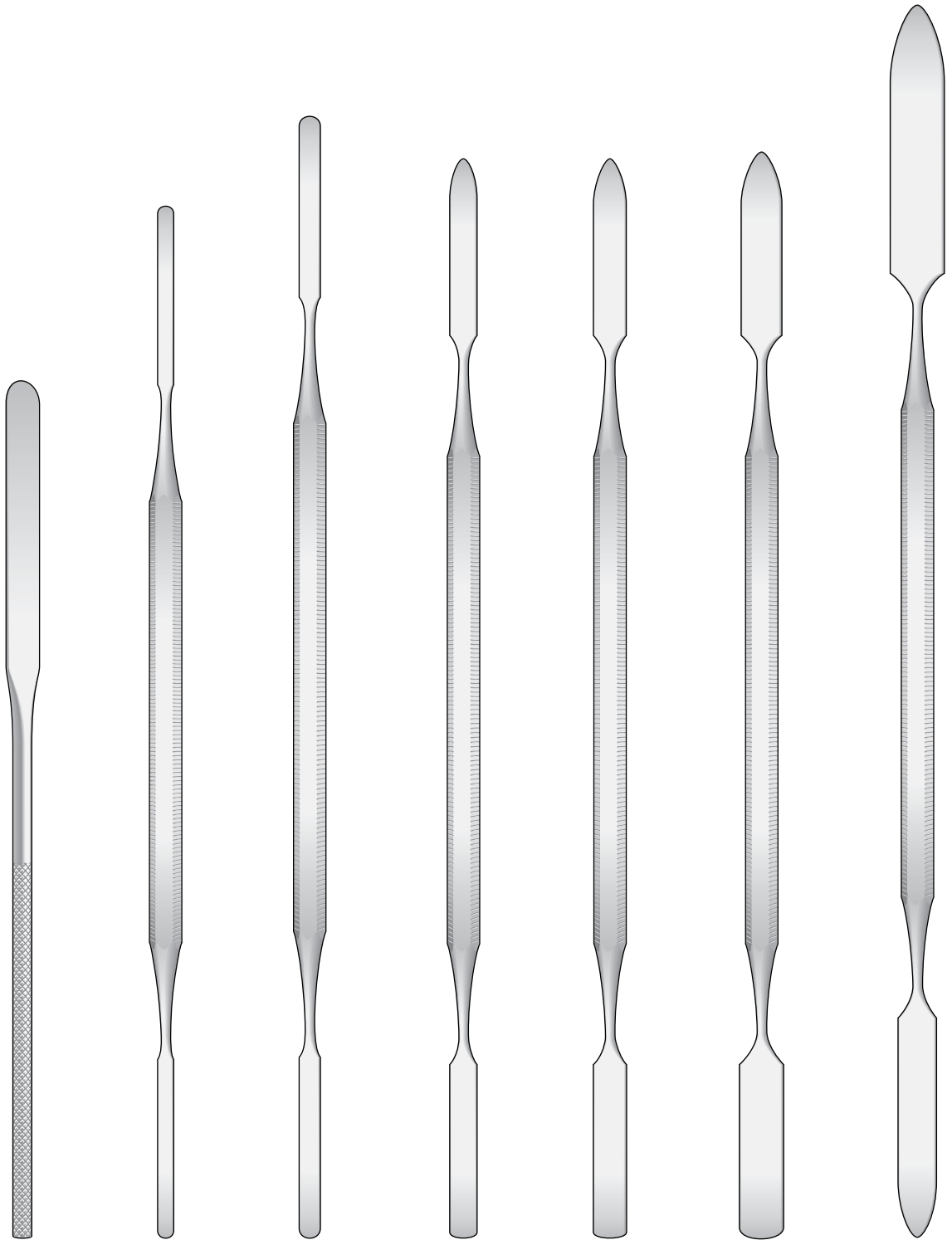

SR
140 mm

S-00
180 mm

S-0
185 mm

S-1
180 mm

S-2
180 mm

S-3
180 mm

S-4
200 mm

Filling Instruments

Füllungsinstrumente
Strumenti per otturazione
Instrumentos para obturación
Instruments pour obturation

Periodontics / Endodontics / Restoration

Parodontologie / Endodontie / Restauration
Parodontie / Endodontie / Restauration
Parodontologia / Endodonzia / Restauro
Parodontologiya / Endodontiya / Restavratsiya

Heidemann-Spateln
Heidemann Spatulas
Spatole Heidemann
Espátulas Heidemann
Spatules Heidemann

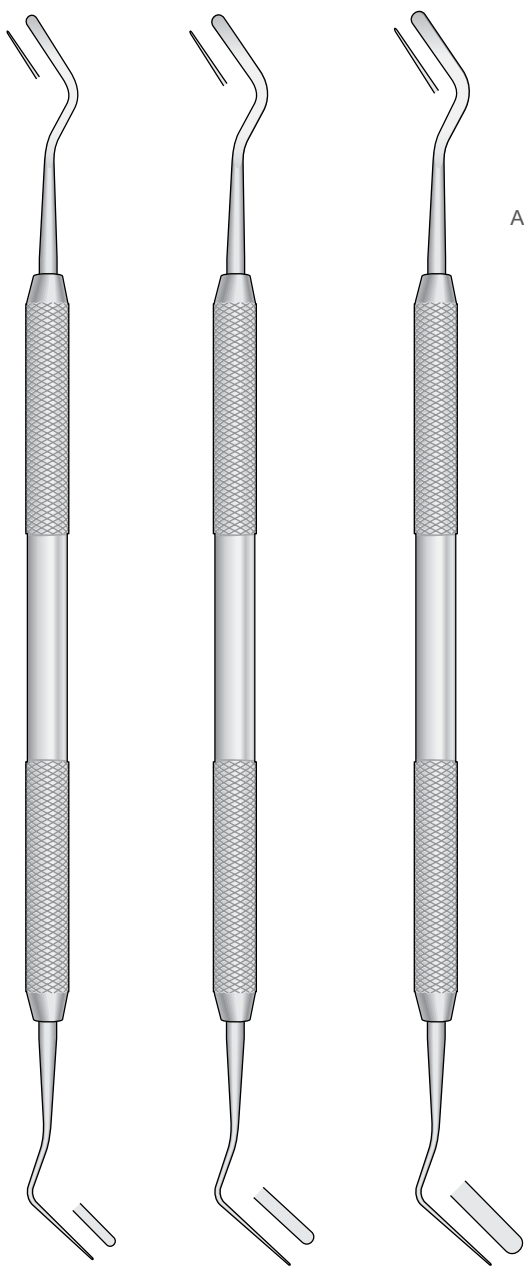

H-1
Fig. 1

H-2
Fig. 2

H-3
Fig. 3

Dycal Applikator
Placement Instrument
Aplicatore per sottofondo
Aplicadores de fondo
de cavidades
Applicateur de fond
de cavité



A-1
125 mm

Amalgam Instrumente
Amalgam Carvers
Strumenti per modellare l'amalgama
Instrumentos para modelar las obturaciones
Instruments à modeler l'amalgame

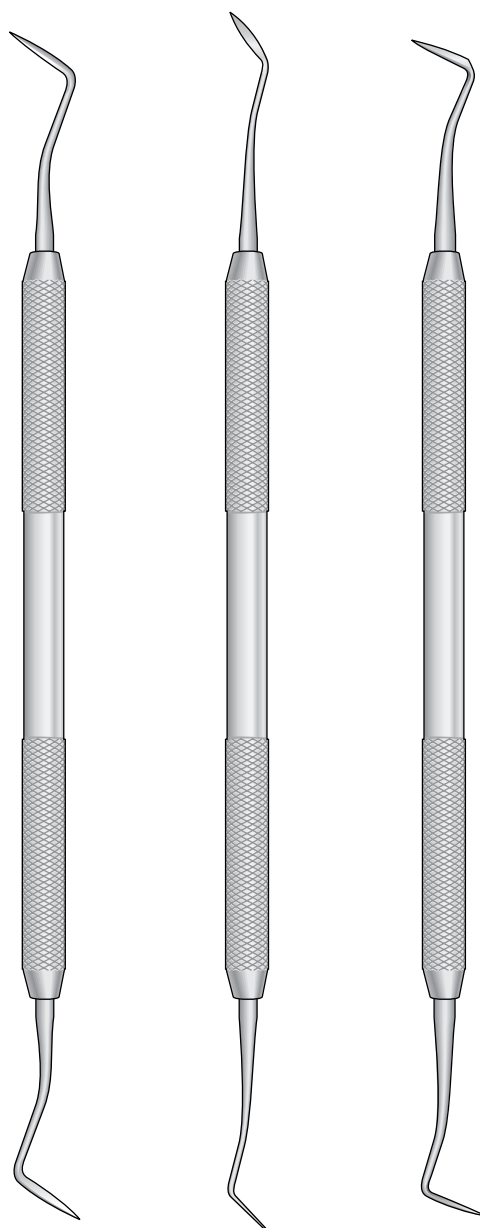

R-1
HOLLENBACH
1 - 165 mm

R-2
HOLLENBACH
1/2 - 165 mm

R-3
HOLLENBACH
3 - 165 mm

Amalgam Carvers

Amalgam Instrumente

Strumenti per modellare l'amalgama

Instrumentos para modelar las obturaciones

Instruments à modeler l'amalgame

Instrument für Drahrückzug
Instrument for retractor wire
Strumento per filo retrattore
Instrumento para hilo separador
Instruments pour fil séparateur

Cleoids - Discoids

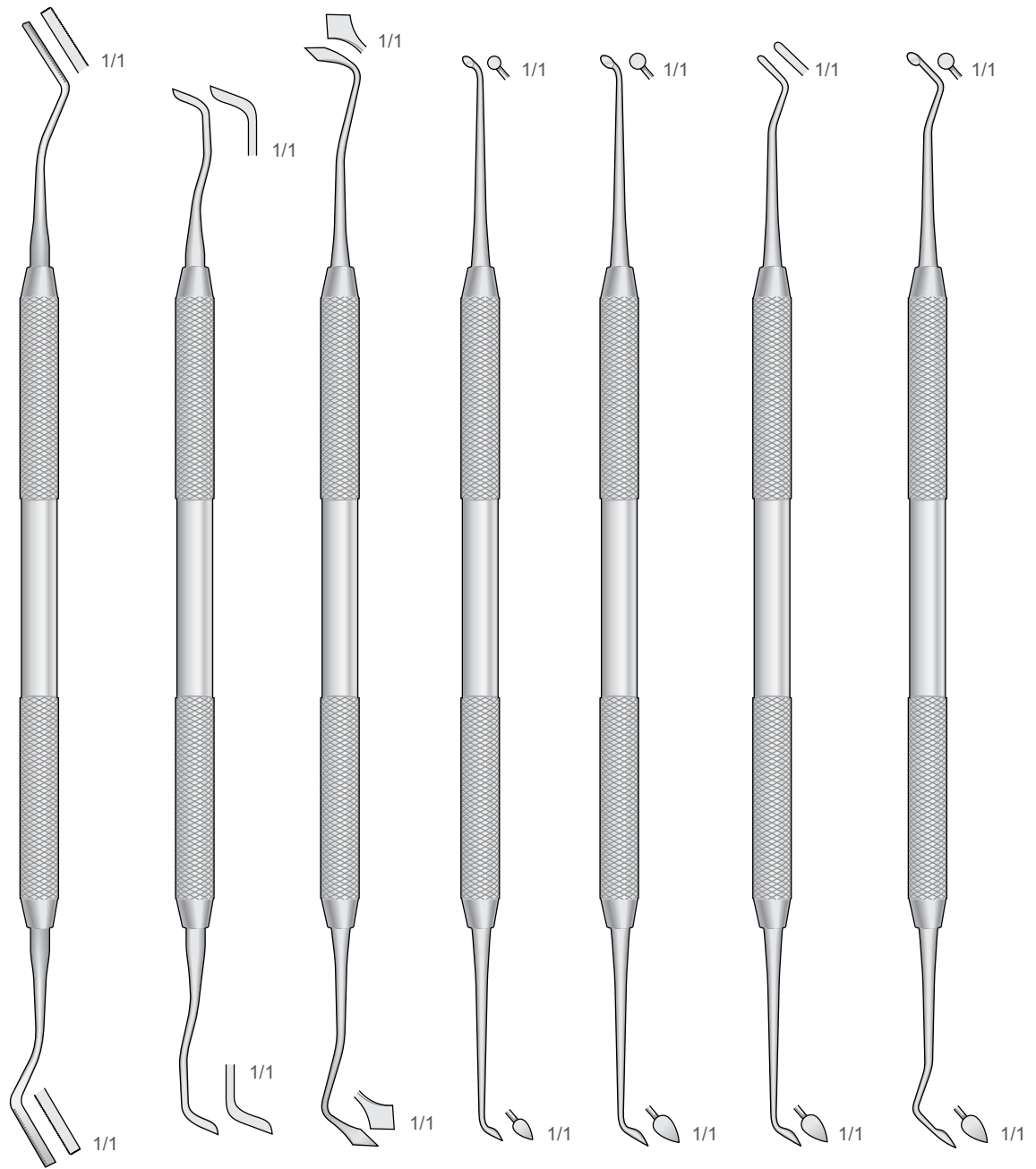

CV-11

USC-2
USC

F-2/3
FRAHM

CD-1
Fig. 1/2

CD-2
Fig. 4/5

CD-3
Fig. W.A.C.D.

CD-4
Fig. 3/6

Filling Instruments

Füllungsinstrumente
Strumenti per otturazione
Instrumentos para obturación
Instruments pour obturation

Periodontics / Endodontics / Restoration

Parodontologie / Endodontie / Restauration
Parodontie / Endodontie / Restauration
Parodontologia / Endodonzia / Restauro
Parodontologiya / Endodontiya / Restavratsiya

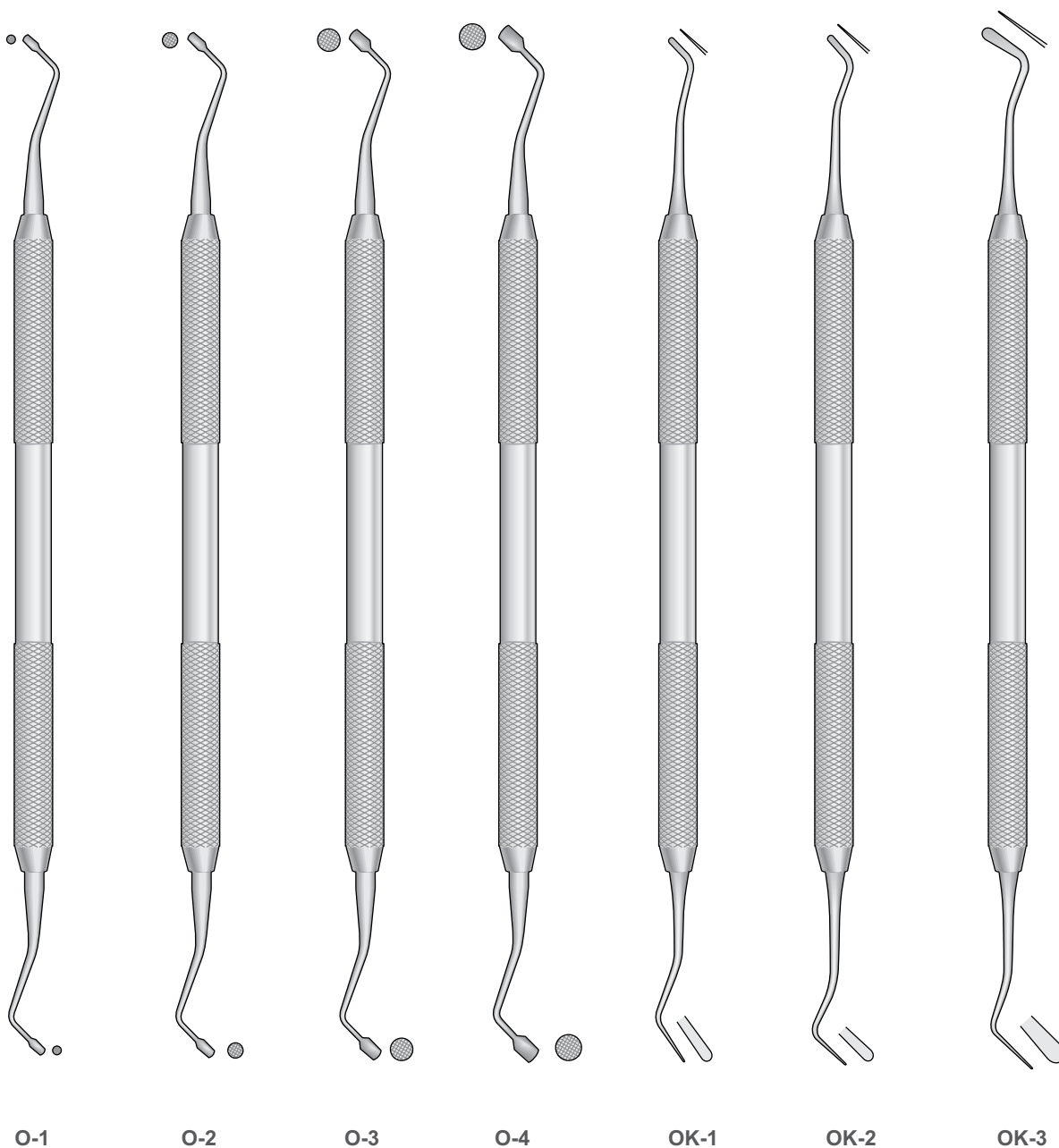

Filling Instruments

Füllungsinstrumente
Strumenti per otturazione
Instrumentos para obturación
Instruments pour obturation

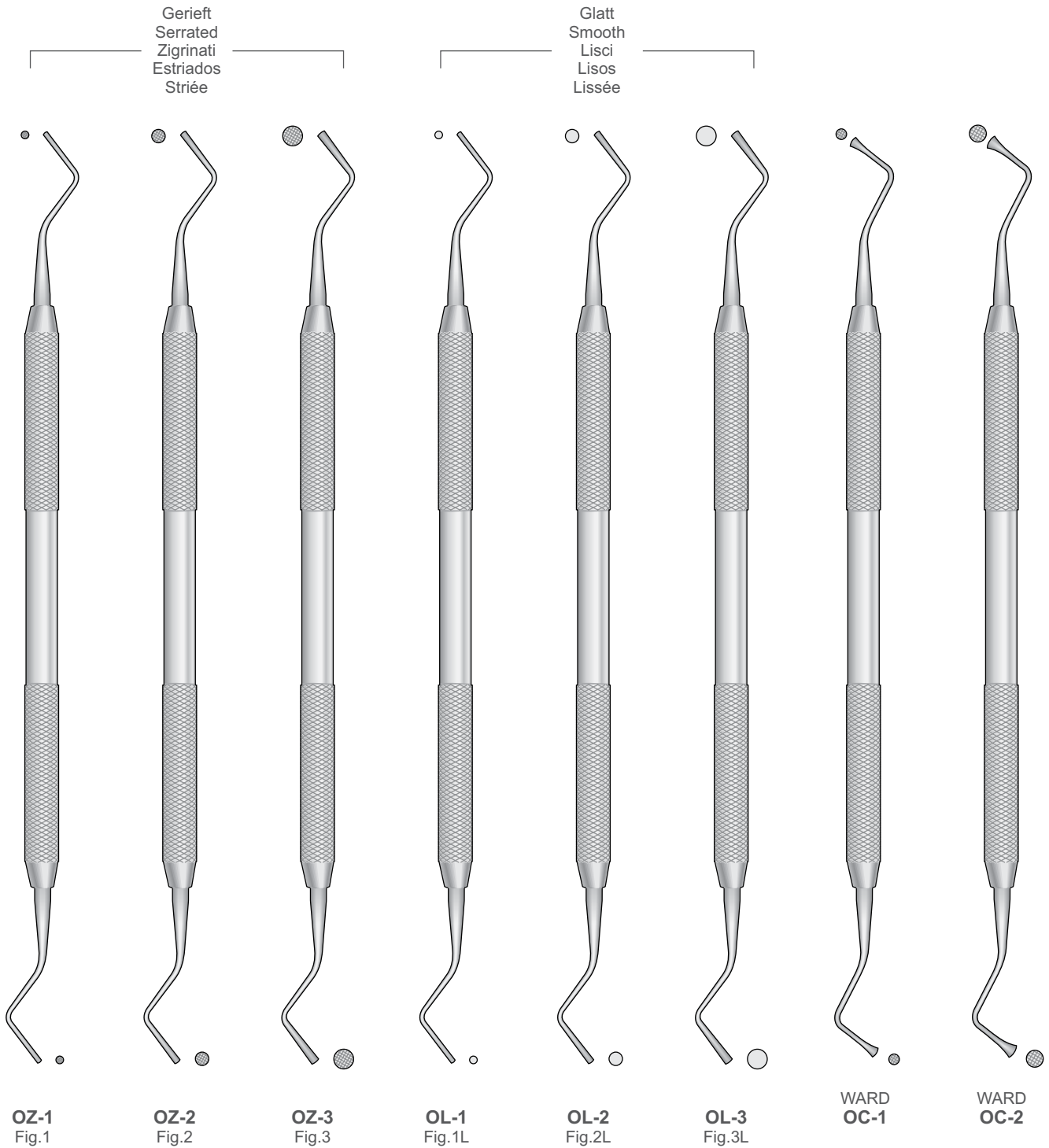

Filling Instruments

Füllungsinstrumente
Strumenti per otturazione
Instrumentos para obturación
Instruments pour obturation

Periodontics / Endodontics / Restoration

Parodontologie / Endodontie / Restauration
Parodontie / Endodontie / Restauration
Parodontologia / Endodonzia / Restauro
Parodontologiya / Endodontiya / Restavratsiya

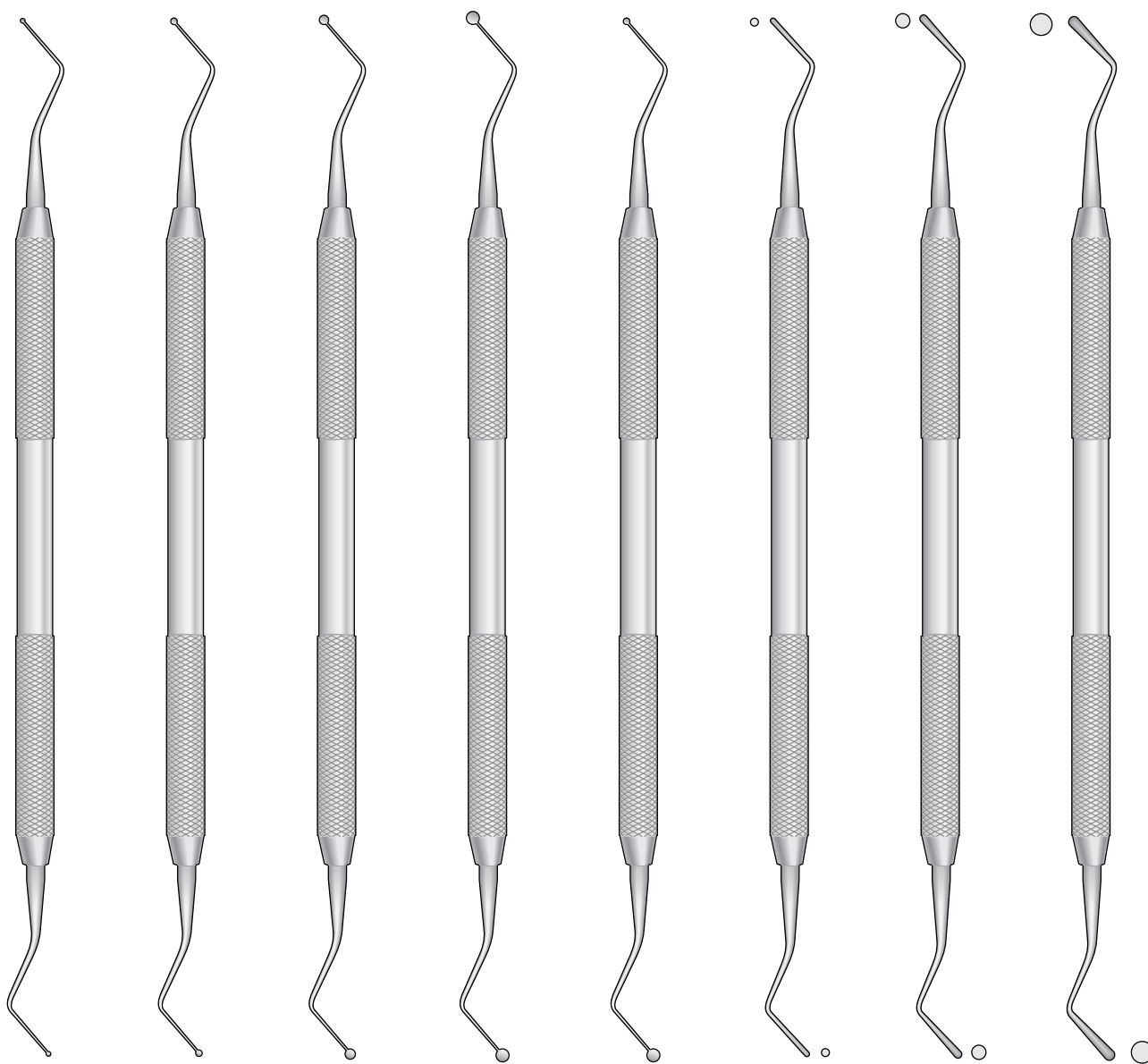

OP-1
Fig.1

OP-2
Fig.2

OP-3
Fig.3

OP-4
Fig.4

OP-5
Fig.5

OA-1
Fig.1

OA-2
Fig.2

OA-3
Fig.3

Filling Instruments

Füllungsinstrumente
Strumenti per otturazione
Instrumentos para obturación
Instruments pour obturation

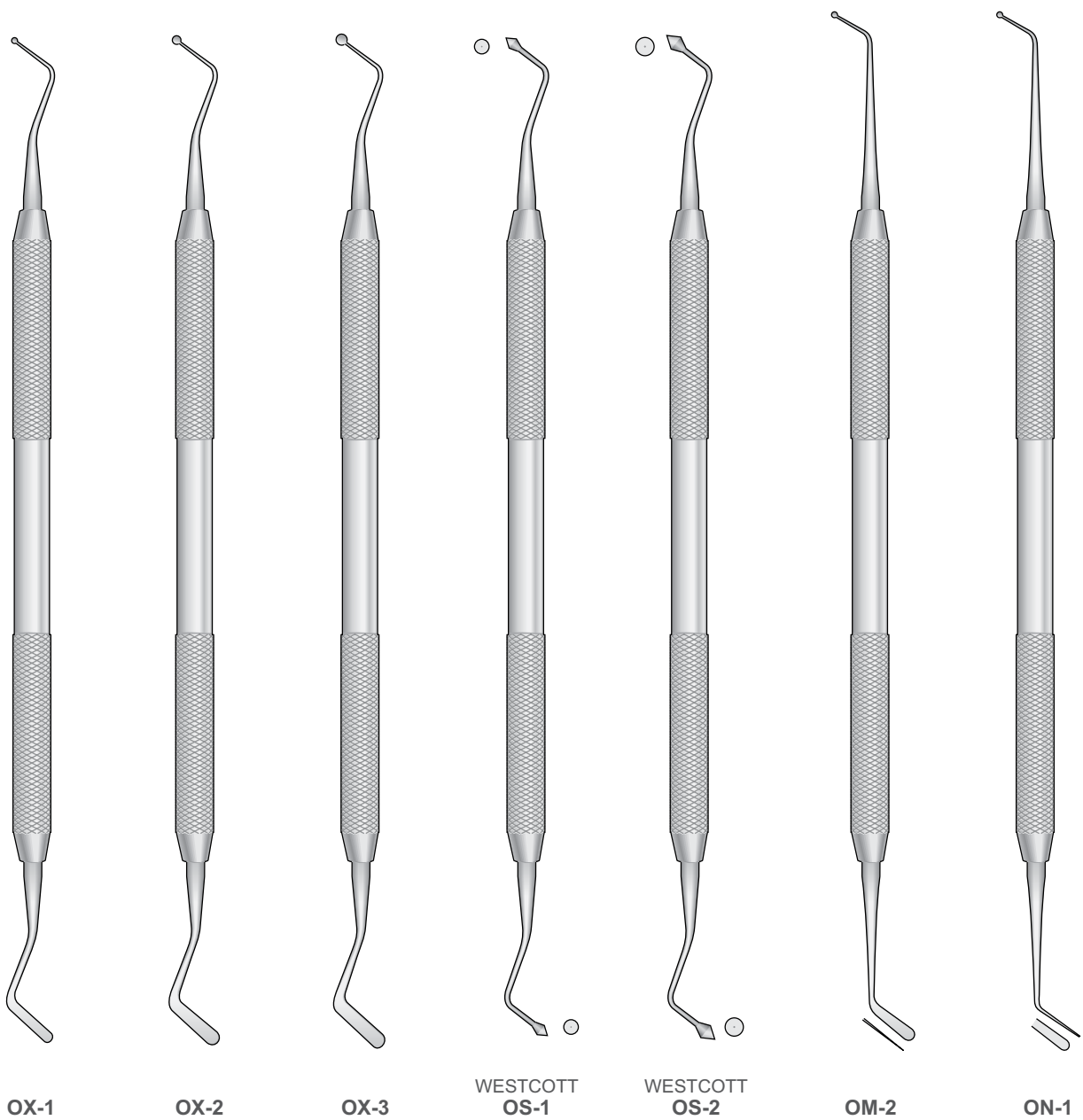

Dental Restoration

Restaurative Zahnheilkunde
Odontoiatria conservativa
Odontología conservadora
Odontologie conservatrice

Periodontics / Endodontics / Restoration

Parodontologie / Endodontie / Restauration
Parodontie / Endodontie / Restauration
Parodontologia / Endodonzia / Restauro
Parodontologiya / Endodontiya / Restavratsiya

Füllungsinstrumente
Filling Instruments
Strumenti per otturazione
Instrumentos para obturación
Instruments pour obturation

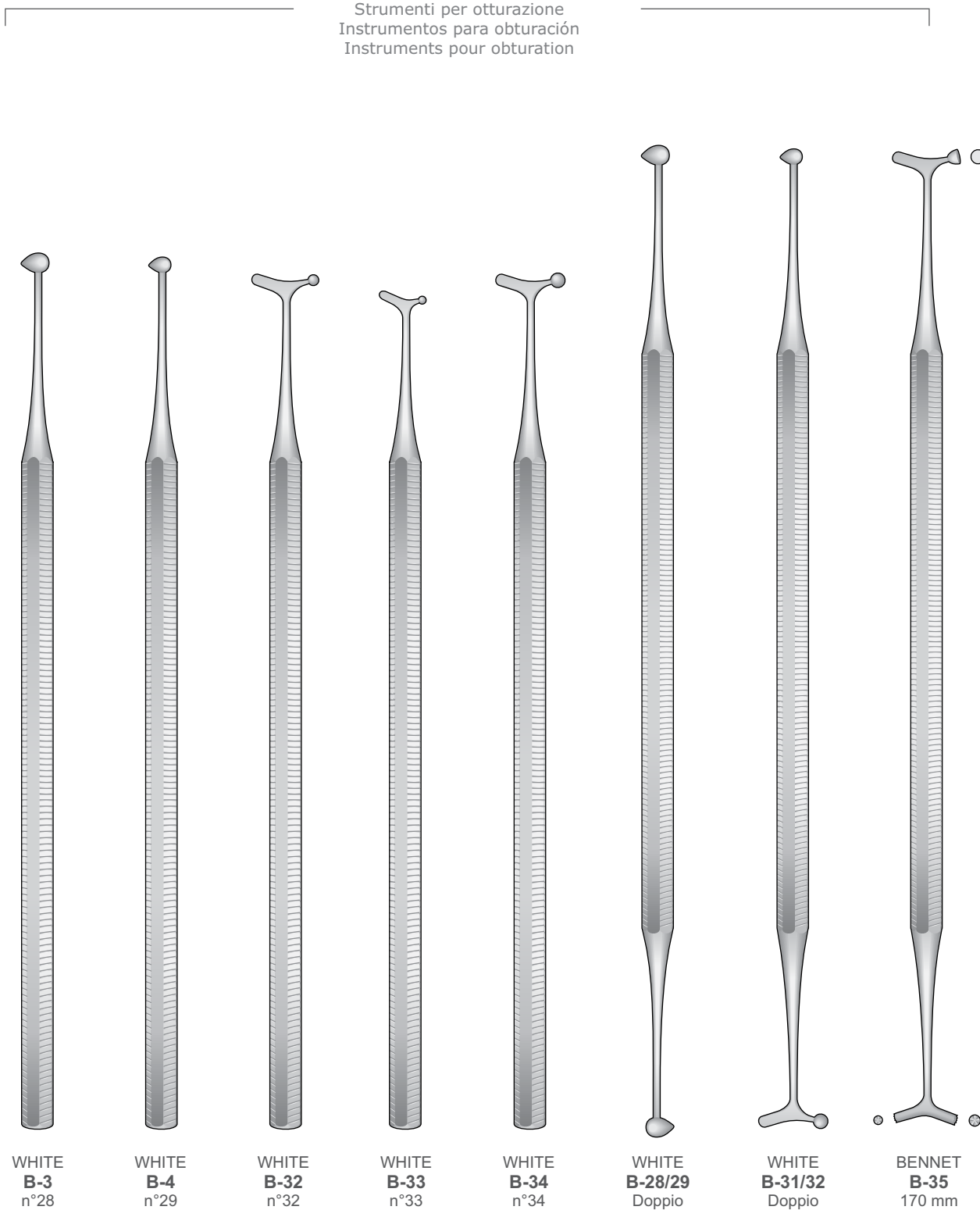

Filling Instruments

Füllungsinstrumente
Strumenti per otturazione
Instrumentos para obturación
Instruments pour obturation

MARKLEY PLUGGERS Amalgam Instrumente Amalgam Instruments Strumenti per amalgama Instrumentos para amalgama Instruments à amalgame

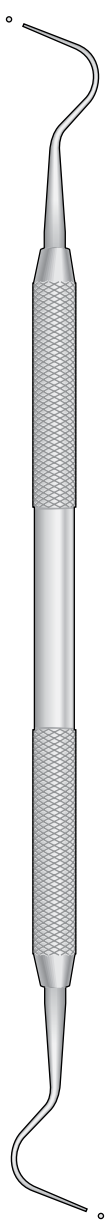

PM-1
Fig.1M

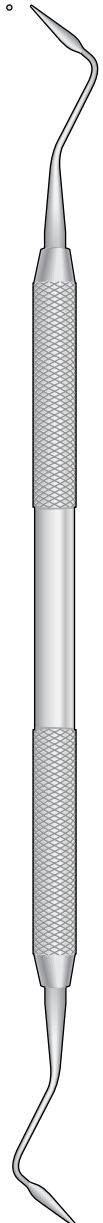

PM-2
Fig.2M

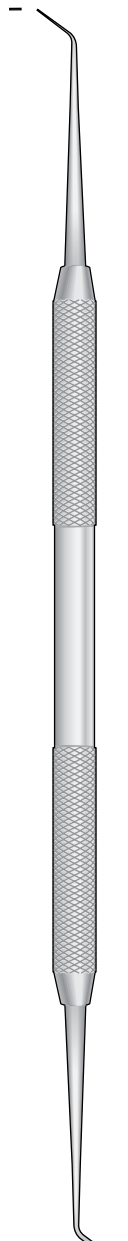

PM-3
Fig.3M

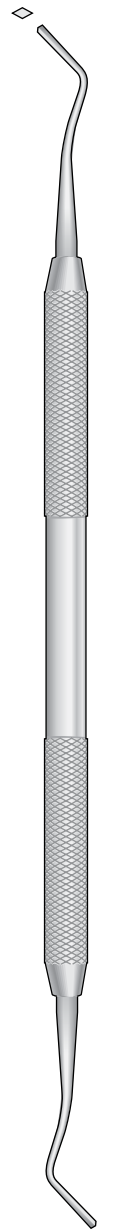

PM-4
Fig.4M



PM-5
Fig.5M

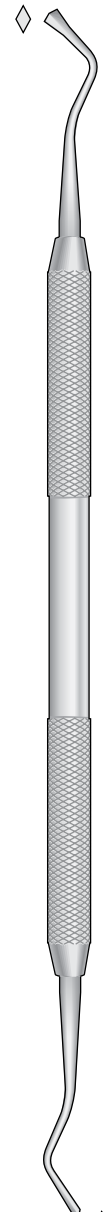

PM-6
Fig.6M

Enamel Instruments

Schmelzinstrumente
Strumenti da smalto
Instrumentos para esmalte
Instruments à émail

Periodontics / Endodontics / Restoration

Parodontologie / Endodontie / Restauration
Parodontie / Endodontie / Restauration
Parodontologia / Endodonzia / Restauro
Parodontologiya / Endodontiya / Restavratsiya

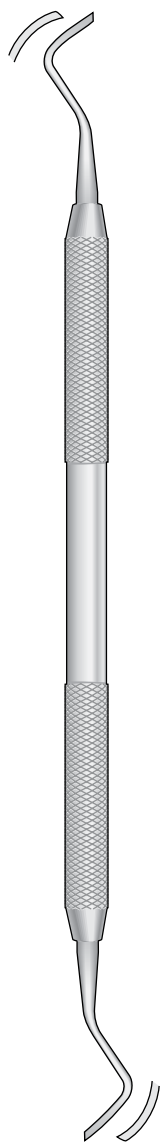

BLACK
TS-1
Fig.26

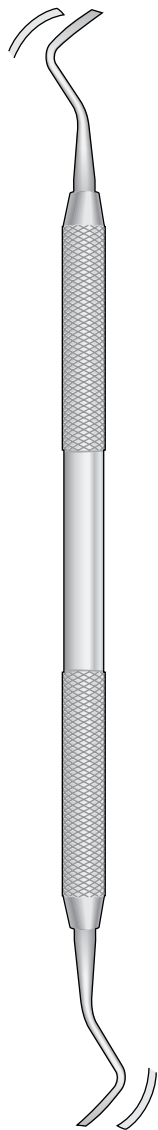

BLACK
TS-2
Fig.27

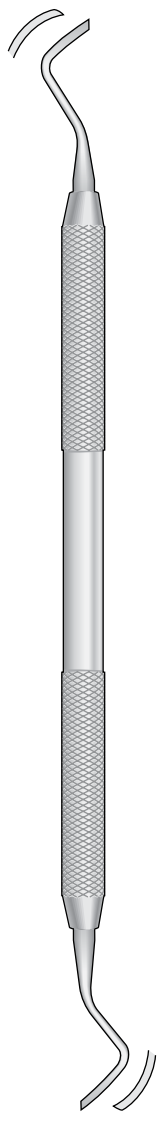

BLACK
TS-3
Fig.28

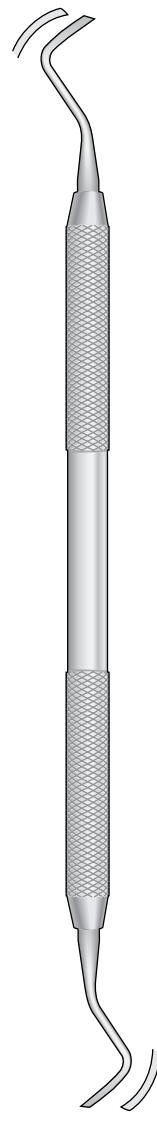

BLACK
TS-4
Fig.29

Excavators

Excavatoren
Escavatori
Excavadores
Excavateurs



E-0
Fig.0



E-1
Fig.1



E-2
Fig.2



E-3
Fig.3



E-4
Fig.4

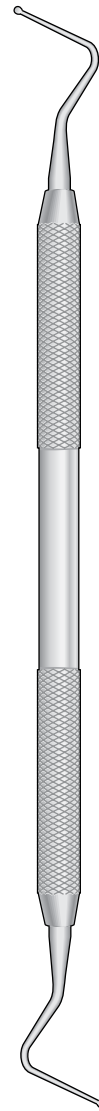

EC-1
Fig.1



EC-2
Fig.2

Periodontal Chisels

Meißel für Parodontologie
Scalpelli parodontali
Cinceles periodontales
Burins parodontaux

Periodontics / Endodontics / Restoration

Parodontologie / Endodontie / Restauration
Parodontie / Endodontie / Restauration
Parodontologia / Endodonzia / Restauro
Parodontologiya / Endodontiya / Restavratsiya

Fig. 1

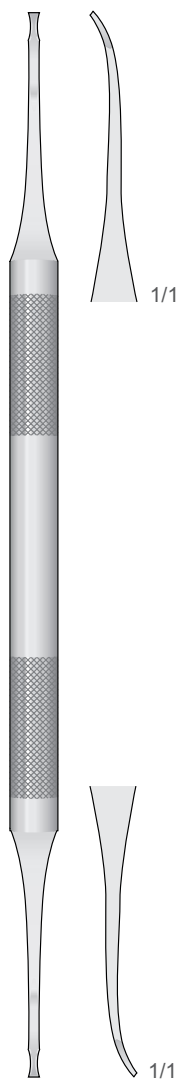

FEDI
OF-1
175 mm

Fig. 2

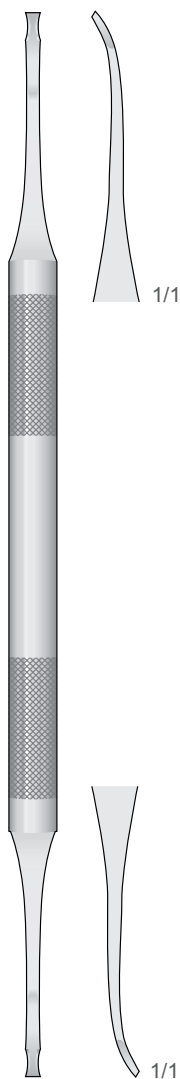

FEDI
OF-2
175 mm

Fig. 3



FEDI
OF-3
170 mm

Fig. 4

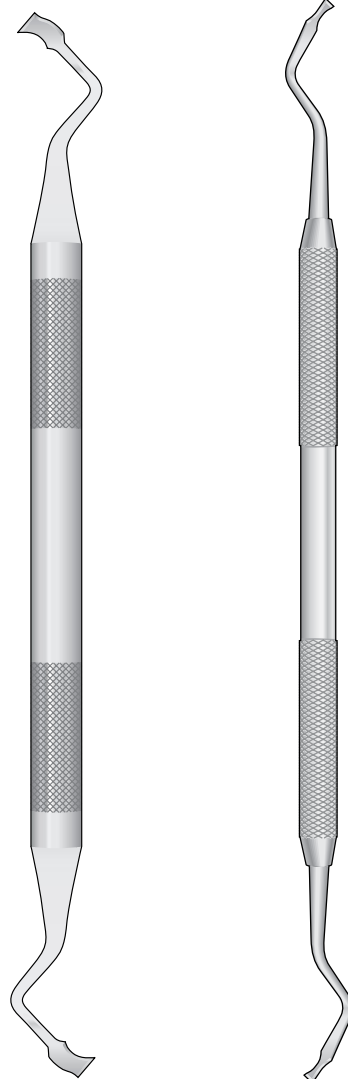

OCHSENBEIN
OSB-4A
170 mm

OCHSENBEIN
OSB-4
170 mm

Periodontal Chisels

Meißel für Parodontologie
Scalpelli parodontali
Cinceles periodontales
Burins parodontaux

Bevel IN
Fig.1



OCHSENBEIN-1
OSB-1
165 mm

Bevel OUT
Fig.2



OCHSENBEIN-2
OSB-2
165 mm



TG CHISELS
718-113

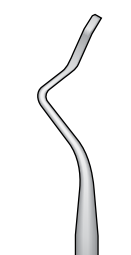

OCHSENBEIN-3
718-103

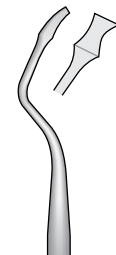

OCHSENBEIN-4
718-104



RHODES BACK ACTION
718-107



Gingivectomy Knives

Parodontalmesser

Bisturi per gengivectomia

Bisturíes para la gengivectomía

Bistouris pour la gengivectomie

Periodontics / Endodontics / Restoration

Parodontologie / Endodontie / Restauration

Parodontie / Endodontie / Restauration

Parodontologia / Endodonzia / Restauro

Parodontologiya / Endodontiya / Restavratsiya

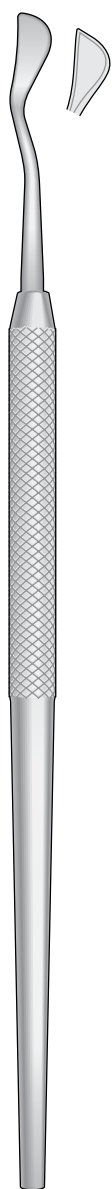

KIRKLAND
KKD-1
Fig.15K

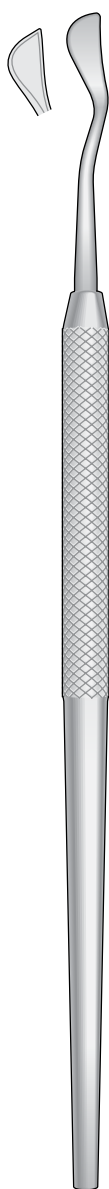

KIRKLAND
KKD-2
Fig.16K

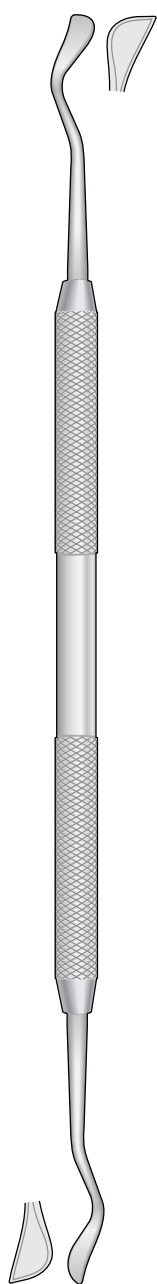

KIRKLAND
KKD-4
Fig.15K - Fig.16K

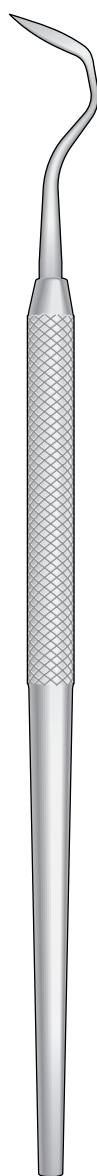

ORBAN
OBN-1
Fig.1

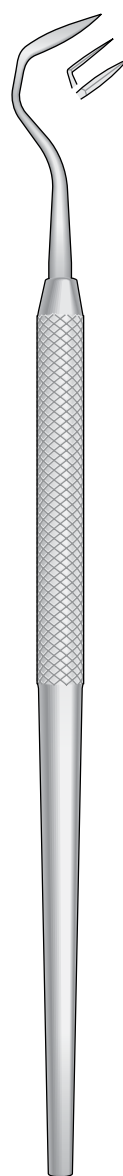

ORBAN
OBN-2
Fig.2

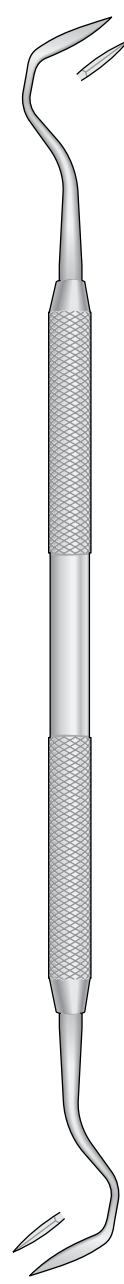

ORBAN
OBN-4
Fig.1 - Fig.2

Double-ended Explorer

Doppelendiger Zahnsonden

Sonda falce doppia

Sonda exploradora doble

Sonde exploratrice double

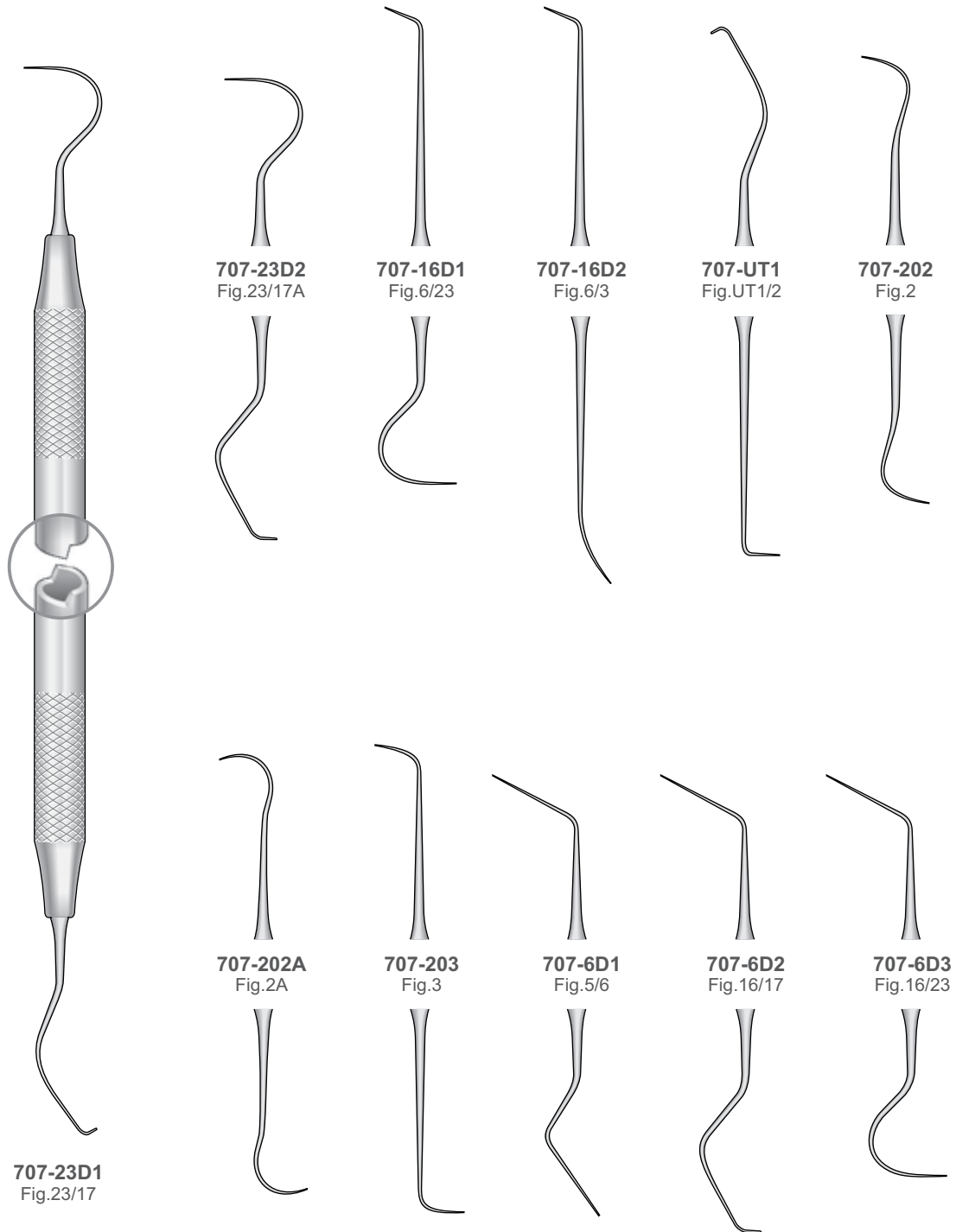

Double-ended Periodontal Probes

Doppelendiger Parodontometer
 Sondes parodontales doubles
 Sonde parodontali doppie
 Sondas parodontales doubles

Periodontics / Endodontics / Restoration

Parodontologie / Endodontie / Restauration
 Parodontie / Endodontie / Restauration
 Parodontologia / Endodontia / Restauro
 Parodontologiya / Endodontiya / Restavratsiya

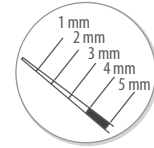
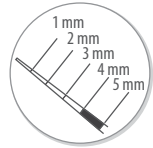

GOLDMANN-FOX

GOLDMANN-FOX WILLIAMS



707-1715
 # CP-15UNC-17A
 170 mm

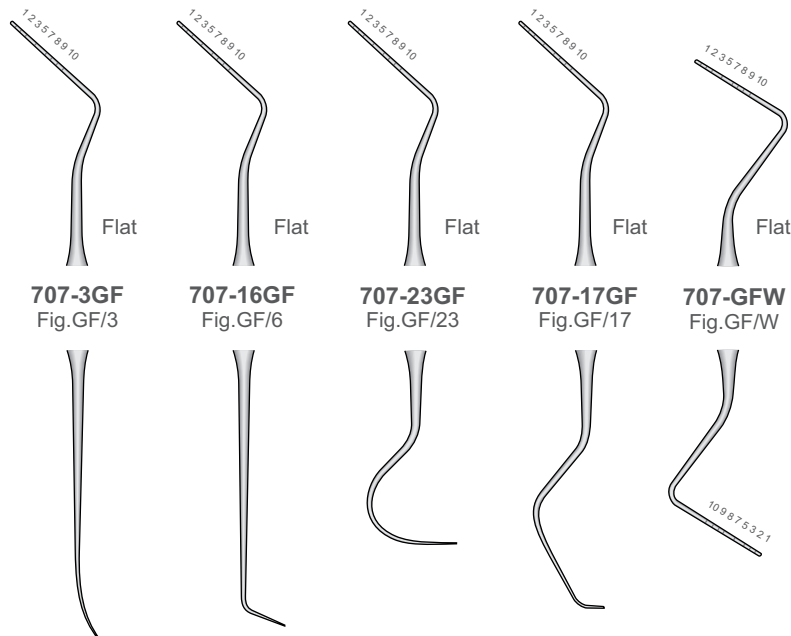

WILLIAMS

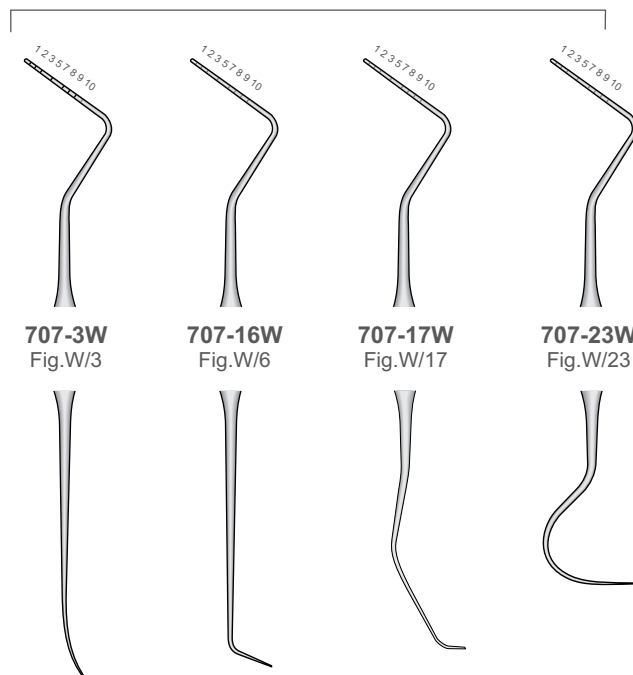

707-2315
 # CP-15UNC-23/W
 170 mm

Double-ended Periodontal Probes

Doppelendiger Parodontometer
 Sondes parodontales doubles
 Sonde parodontali doppie
 Sondas parodontales doubles

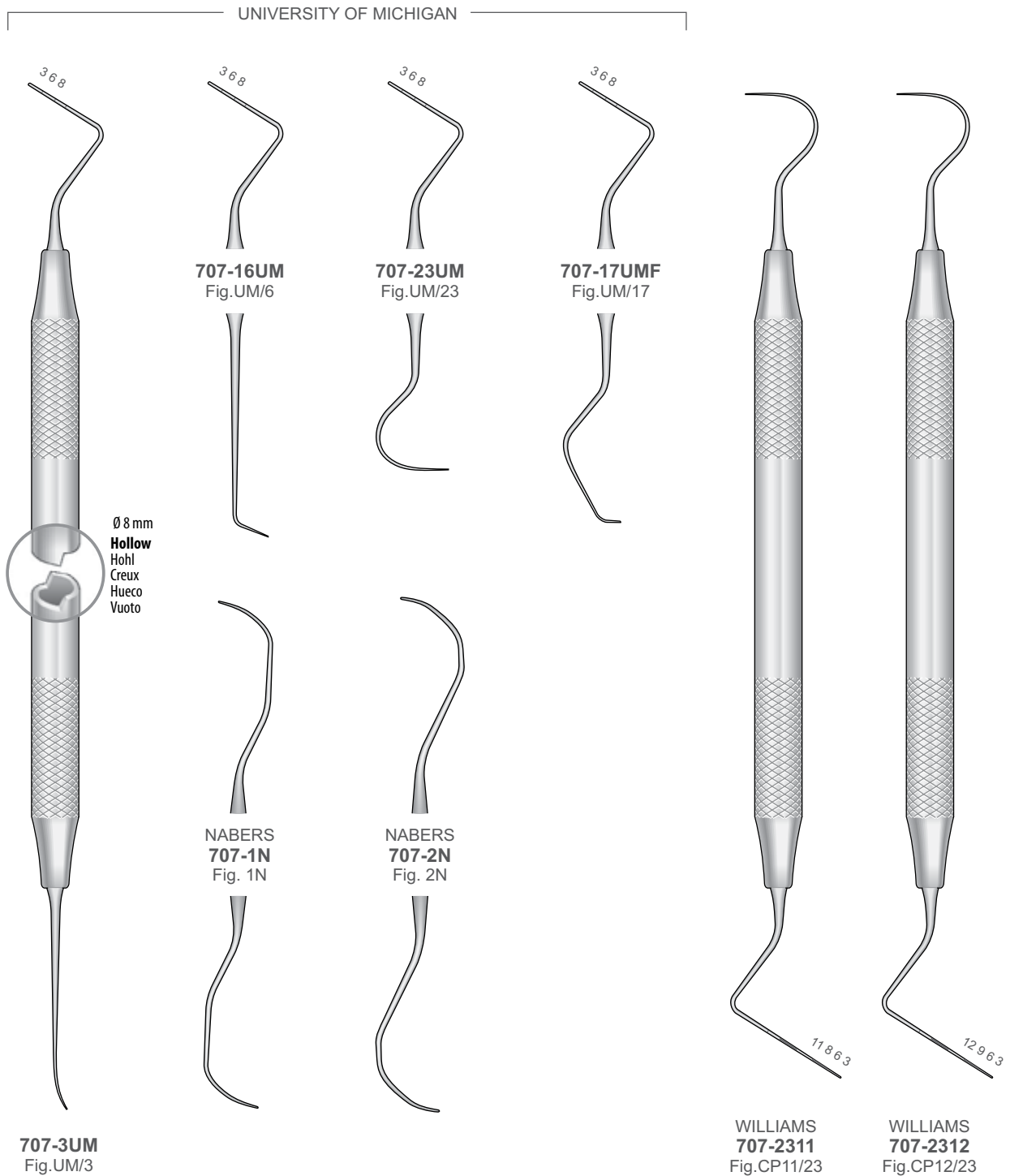

Spatulas - Filling Instruments

Spateln - Füllungsinstrumente
 Spatole - Strumenti per otturazione
 Espátulas - Instrumentos para obturación
 Spatules - Instruments pour obturation

Periodontics / Endodontics / Restoration

Parodontologie / Endodontie / Restauration
 Parodontie / Endodontie / Restauration
 Parodontologia / Endodonzia / Restauro
 Parodontologiya / Endodontiya / Restavratsiya

Heidemann Spateln
 Heidemann Spatulas
 Spatole Heidemann
 Espátulas Heidemann
 Spatules Heidemann

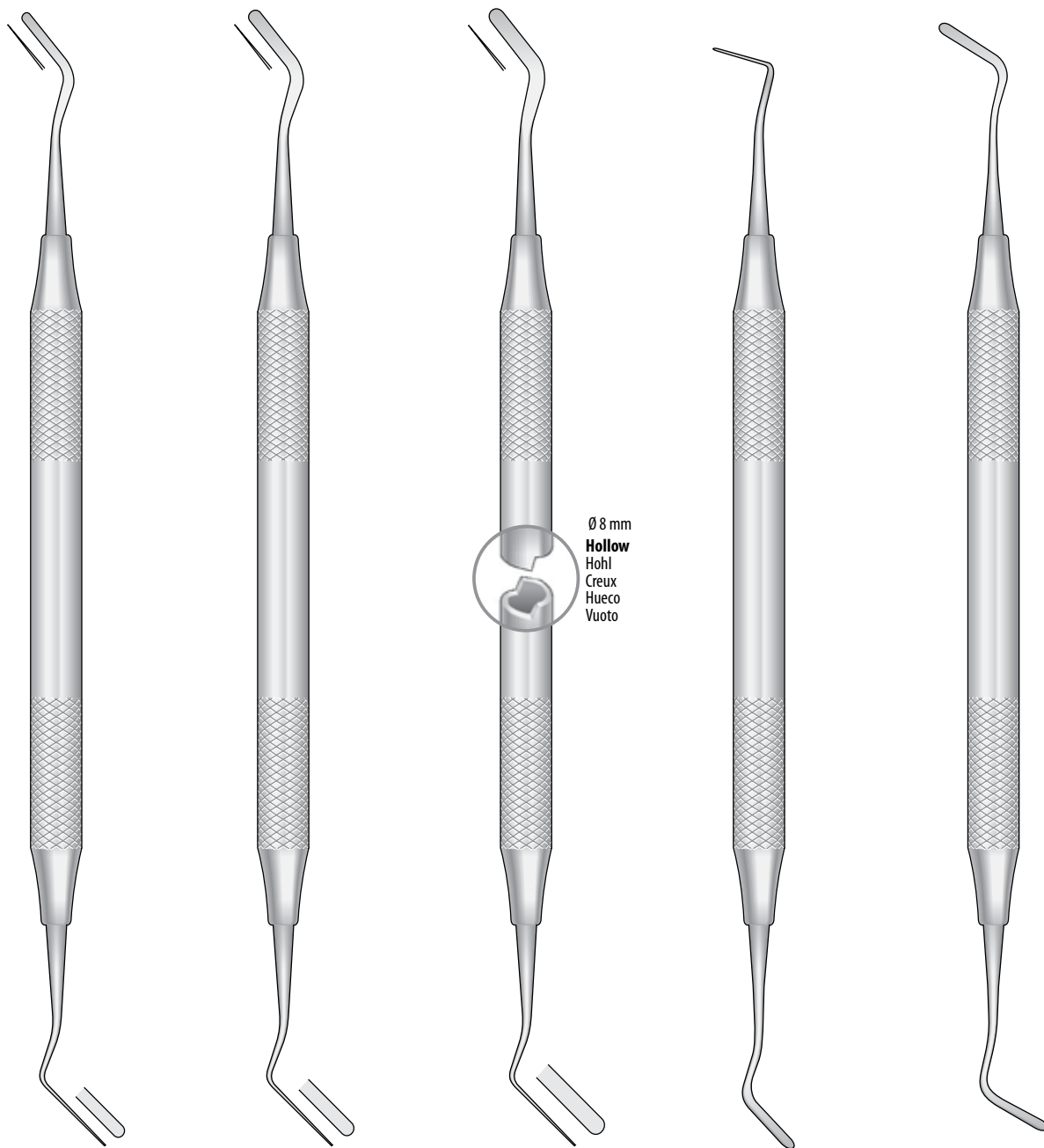

Ø 8 mm
Hollow
 Hohl
 Creux
 Hueco
 Vuoto

HEIDEMANN
711-301
 Fig.1

HEIDEMANN
711-302
 Fig.2

HEIDEMANN
711-303
 Fig.3

IPC Fig. 1
715-311
 Interproximal

IPC/OA Fig. 2
715-312
 Interproximal Off-Angle

Filling Instruments

Füllungsinstrumente
Strumenti per otturazione
Instrumentos para obturación
Instruments pour obturation

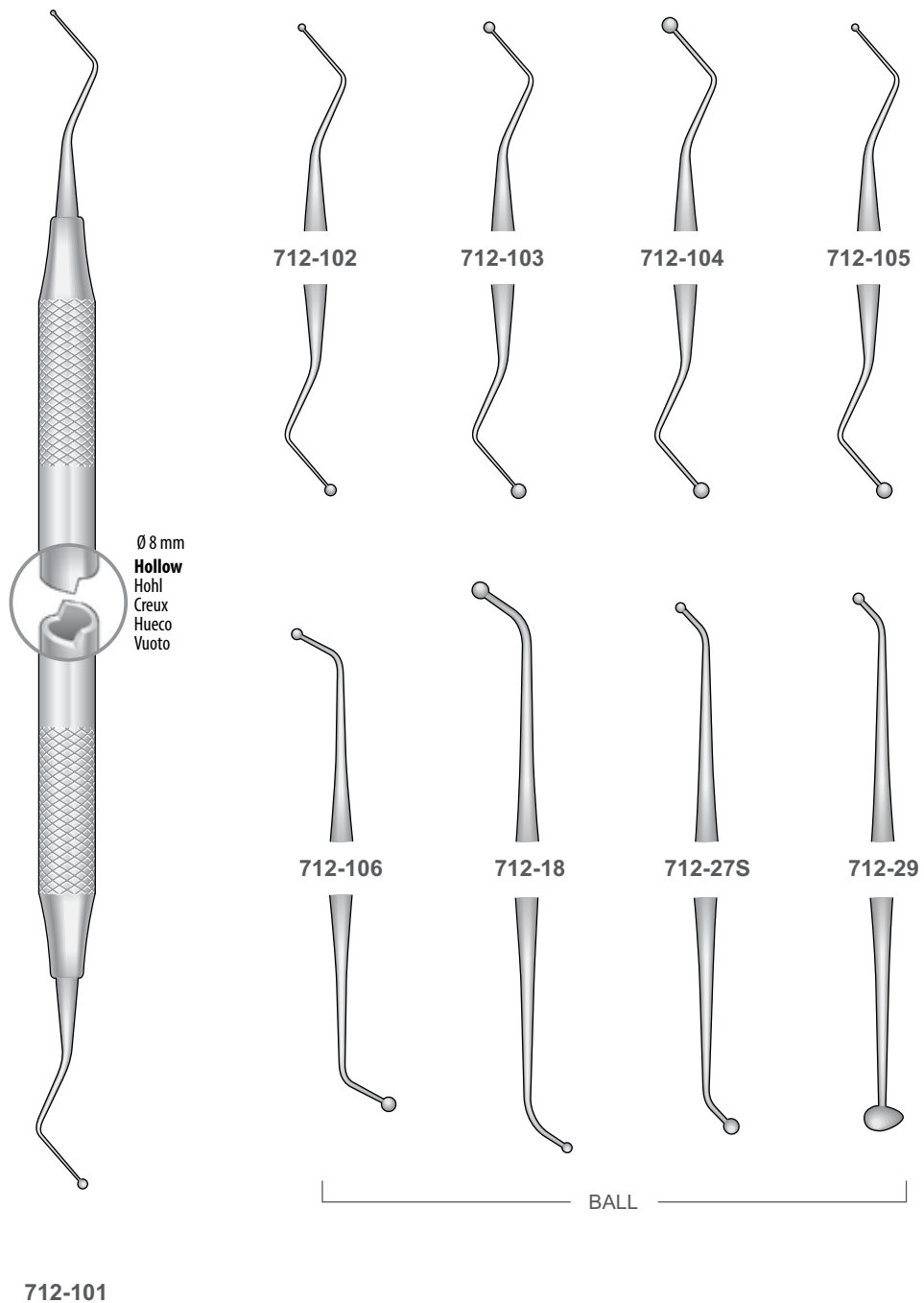

Filling Instruments

Füllungsinstrumente
Strumenti per otturazione
Instrumentos para obturación
Instruments pour obturation

Periodontics / Endodontics / Restoration

Parodontologie / Endodontie / Restauration
Parodontie / Endodontie / Restauration
Parodontologia / Endodonzia / Restauro
Parodontologiya / Endodontiya / Restavratsiya

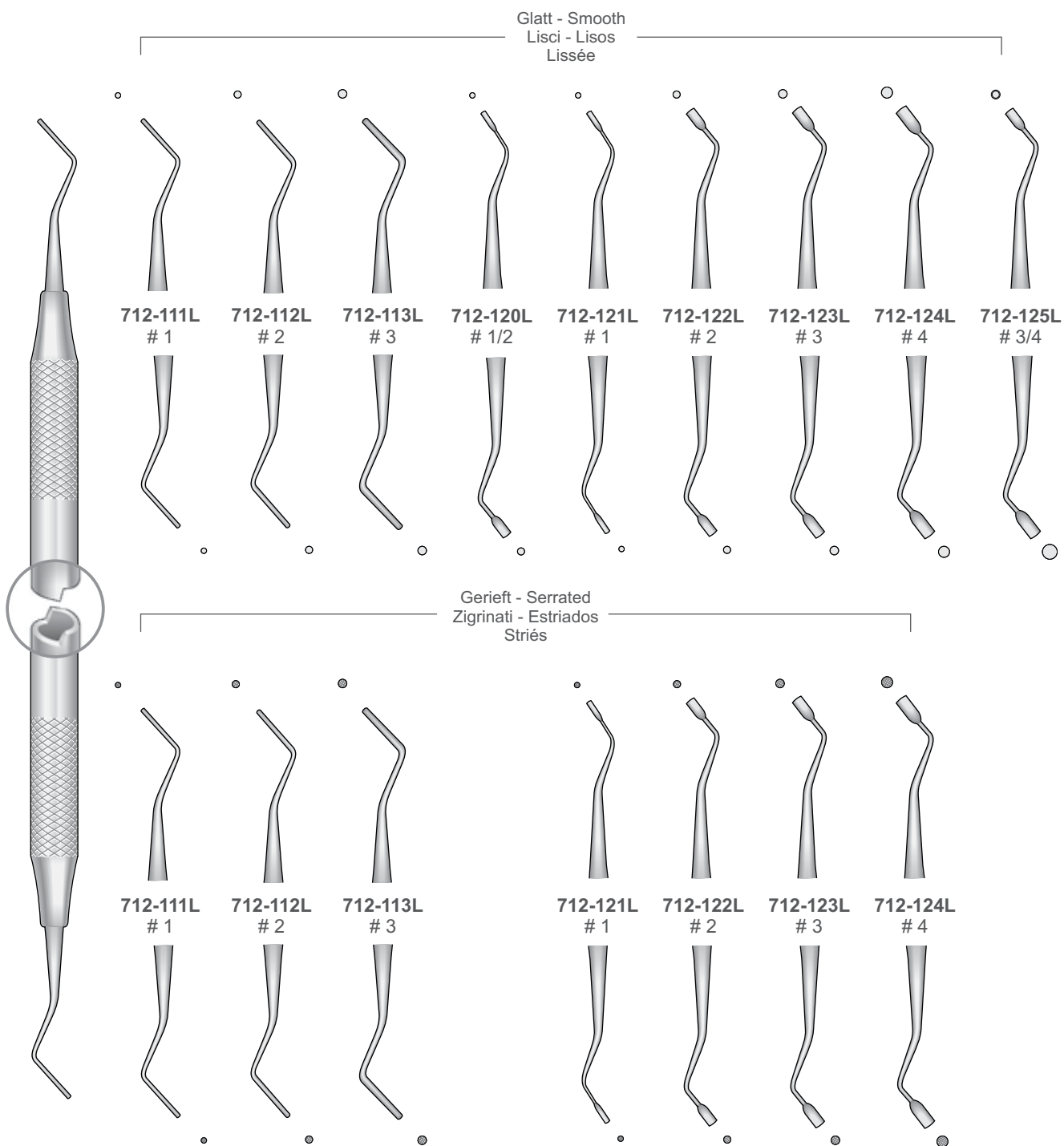

Filling Instruments

Füllungsinstrumente
Strumenti per otturazione
Instrumentos para obturación
Instruments pour obturation

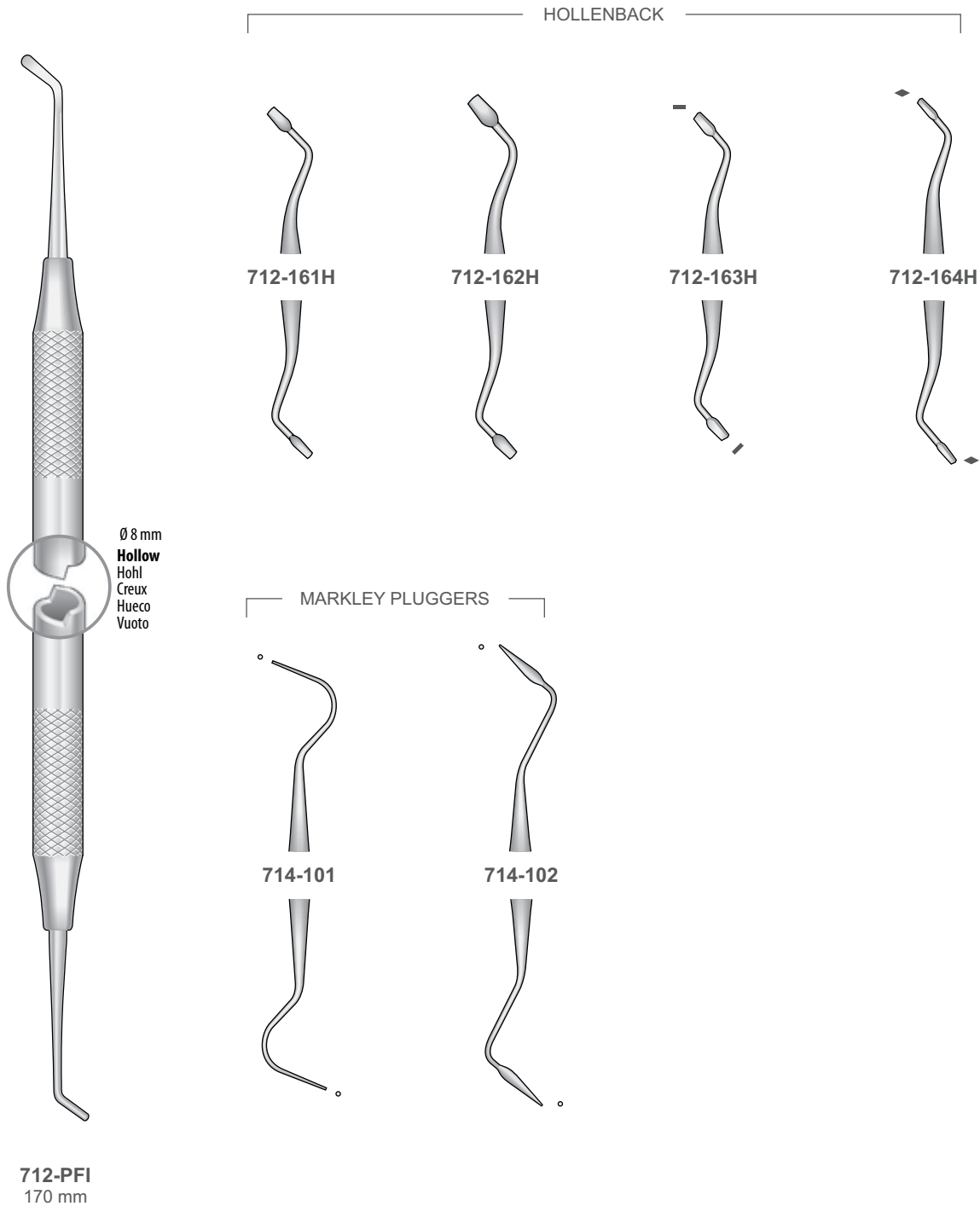

Filling Instruments

Füllungsinstrumente
Strumenti per otturazione
Instrumentos para obturación
Instruments pour obturation

Periodontics / Endodontics / Restoration

Parodontologie / Endodontie / Restauration
Parodontie / Endodontie / Restauration
Parodontologia / Endodonzia / Restauro
Parodontologiya / Endodontiya / Restavratsiya

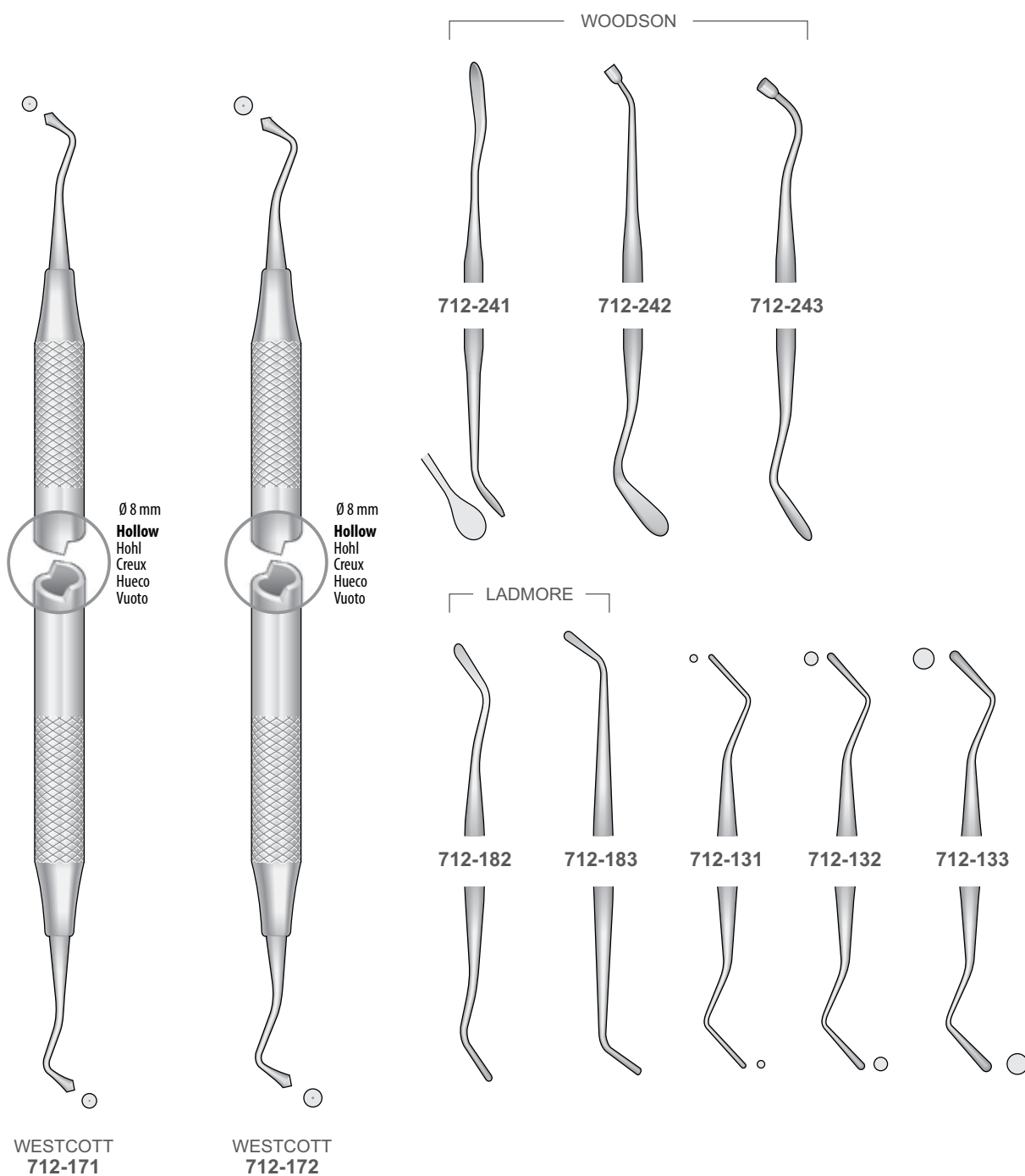

Filling Instruments

Füllungsinstrumente
Strumenti per otturazione
Instrumentos para obturación
Instruments pour obturation

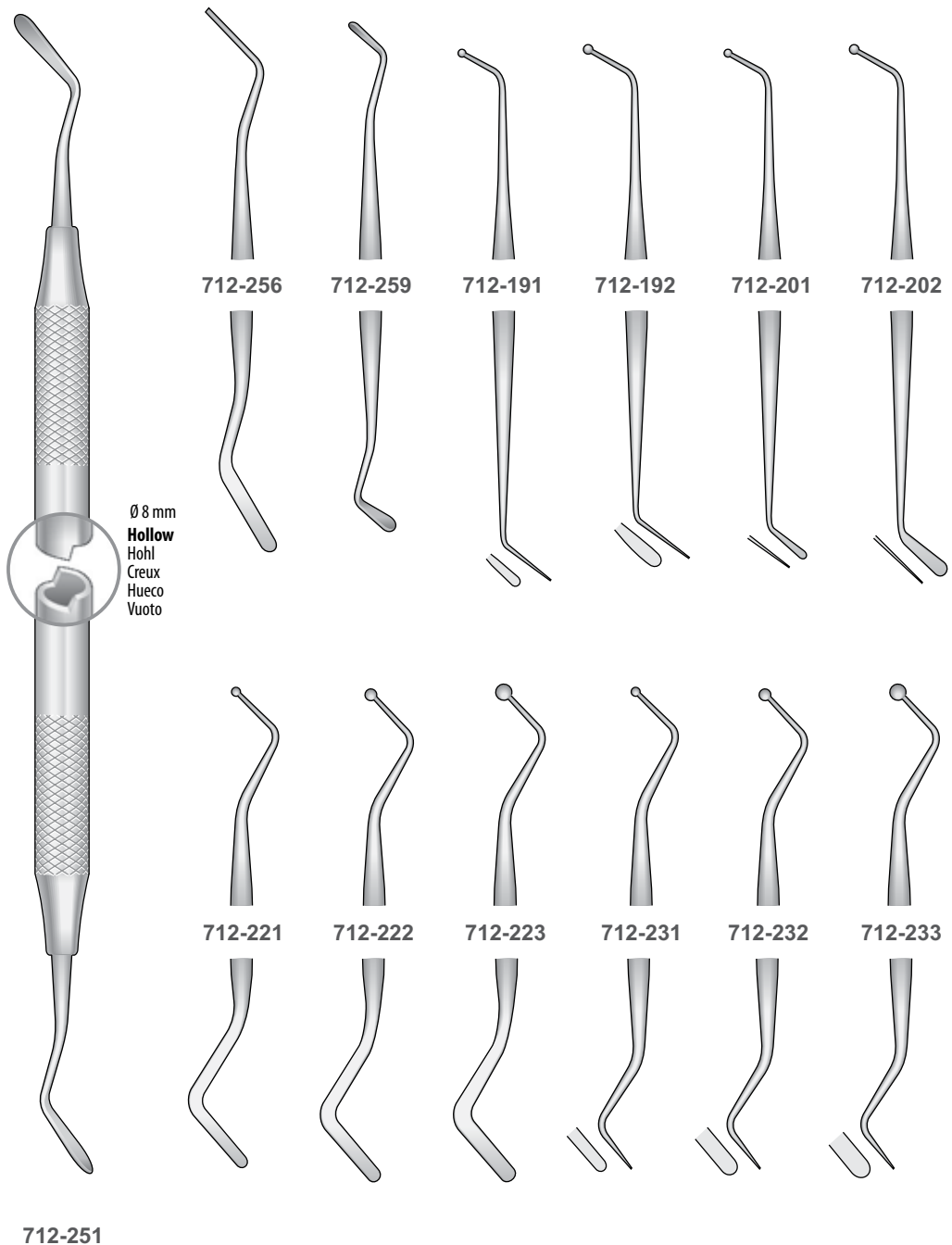

Amalgam carvers

Amalgam Instrumente

Strumenti per modellare otturazioni

Instrumentos para modelar las obturaciones

Instruments à modeler les obturations

Periodontics / Endodontics / Restoration

Parodontologie / Endodontie / Restauration

Parodontie / Endodontie / Restauration

Parodontologia / Endodonzia / Restauro

Parodontologiya / Endodontiya / Restavratsiya

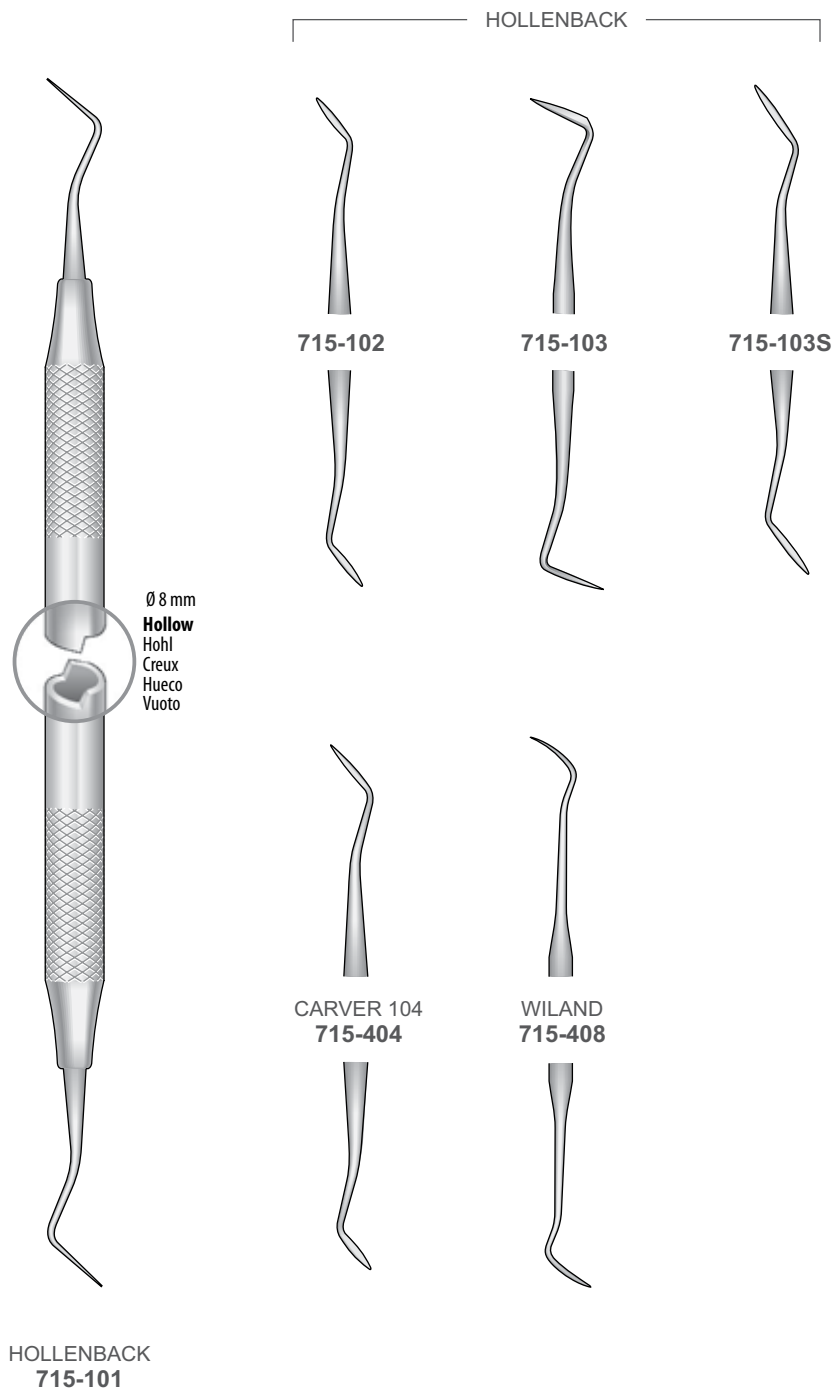

Cavity preparation instruments

Schmelzinstrumente
 Strumenti da smalto
 Instrumentos para esmalte
 Instruments à émail

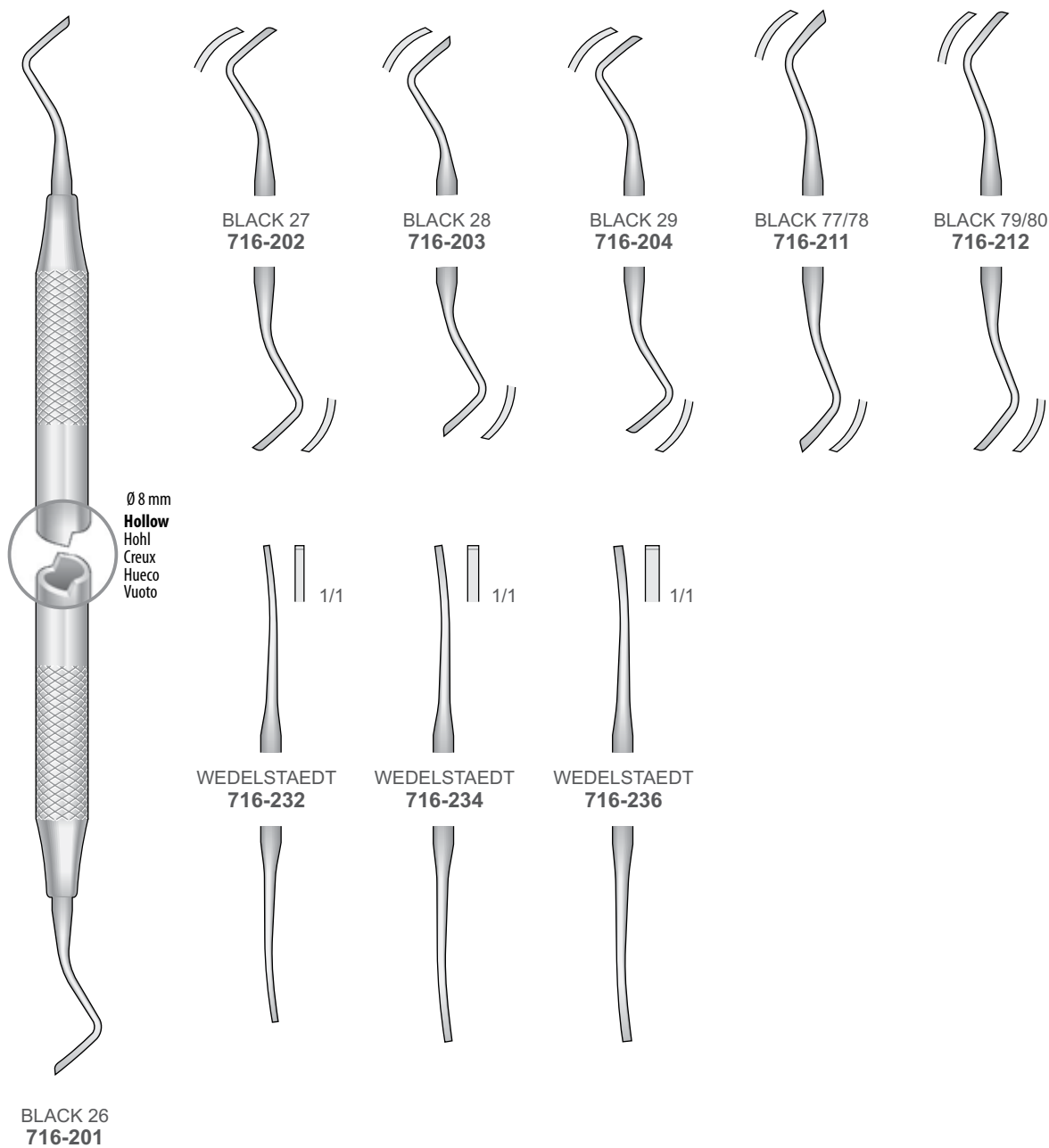

Amalgam carvers

Amalgam Instrumente
Strumenti per modellare otturazioni
Instrumentos para modelar las obturaciones
Instruments à modeler les obturations

Periodontics / Endodontics / Restoration

Parodontologie / Endodontie / Restauration
Parodontie / Endodontie / Restauration
Parodontologia / Endodontia / Restauro
Parodontologiya / Endodontiya / Restavratsiya

Instrument für Drahrückzug
Instrument for Retractor wire
Strumento per filo retrattore
Instrumento para hilo retractor
Instruments pour fil racteureur

Cleoids - Discoids

Dykal Applikator
Placement Instruments
Applicatori per sottofondo
Aplicadores de fondo de cavidades
Applicateurs de fond de cavité

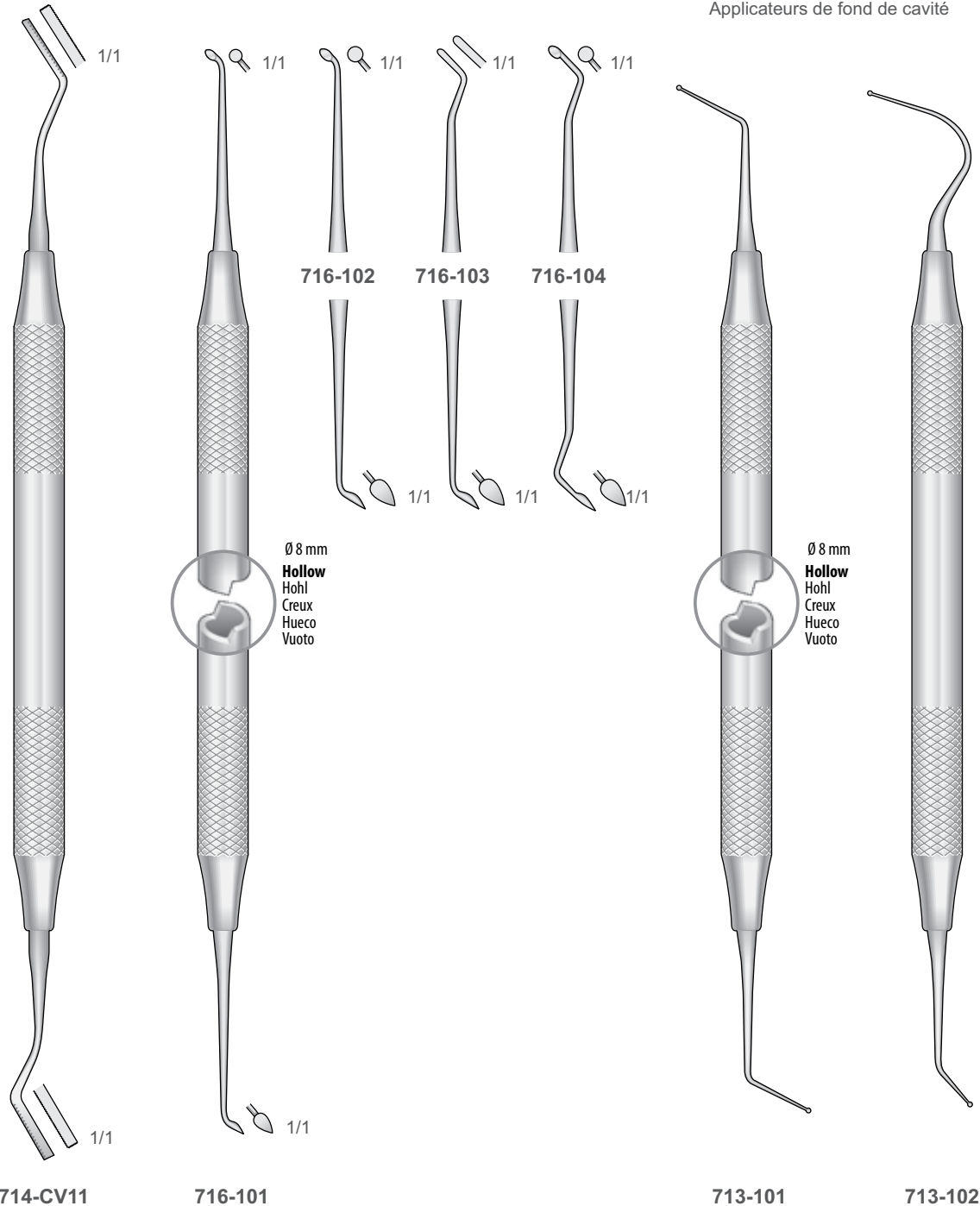

Excavators

Excavatoren
Escavatori
Excavadores
Excavateurs



717-100



717-101



717-102



717-103



717-104



717-6



717-14



717-17



717-18



717-19



717-111



717-112

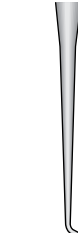

717-17W

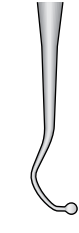

717-18W



717-19W



717-39



717-64



717-66



717-31L

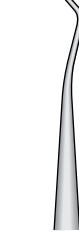

717-32L



717-33L

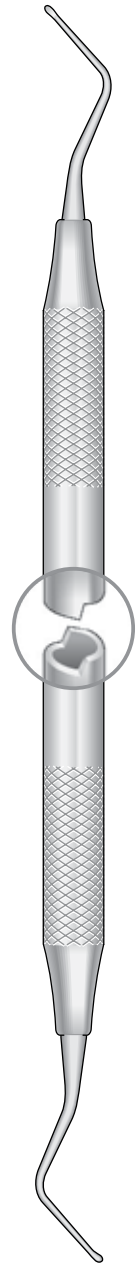

Gingivectomy knives

Parodontalmesser
 Bisturi per gengivectomia
 Bisturíes para la gingivectomía
 Bistouris pour la gingivectomie

Periodontics / Endodontics / Restoration

Parodontologie / Endodontie / Restauration
 Parodontie / Endodontie / Restauration
 Parodontologia / Endodonzia / Restauro
 Parodontologiya / Endodontiya / Restavratsiya

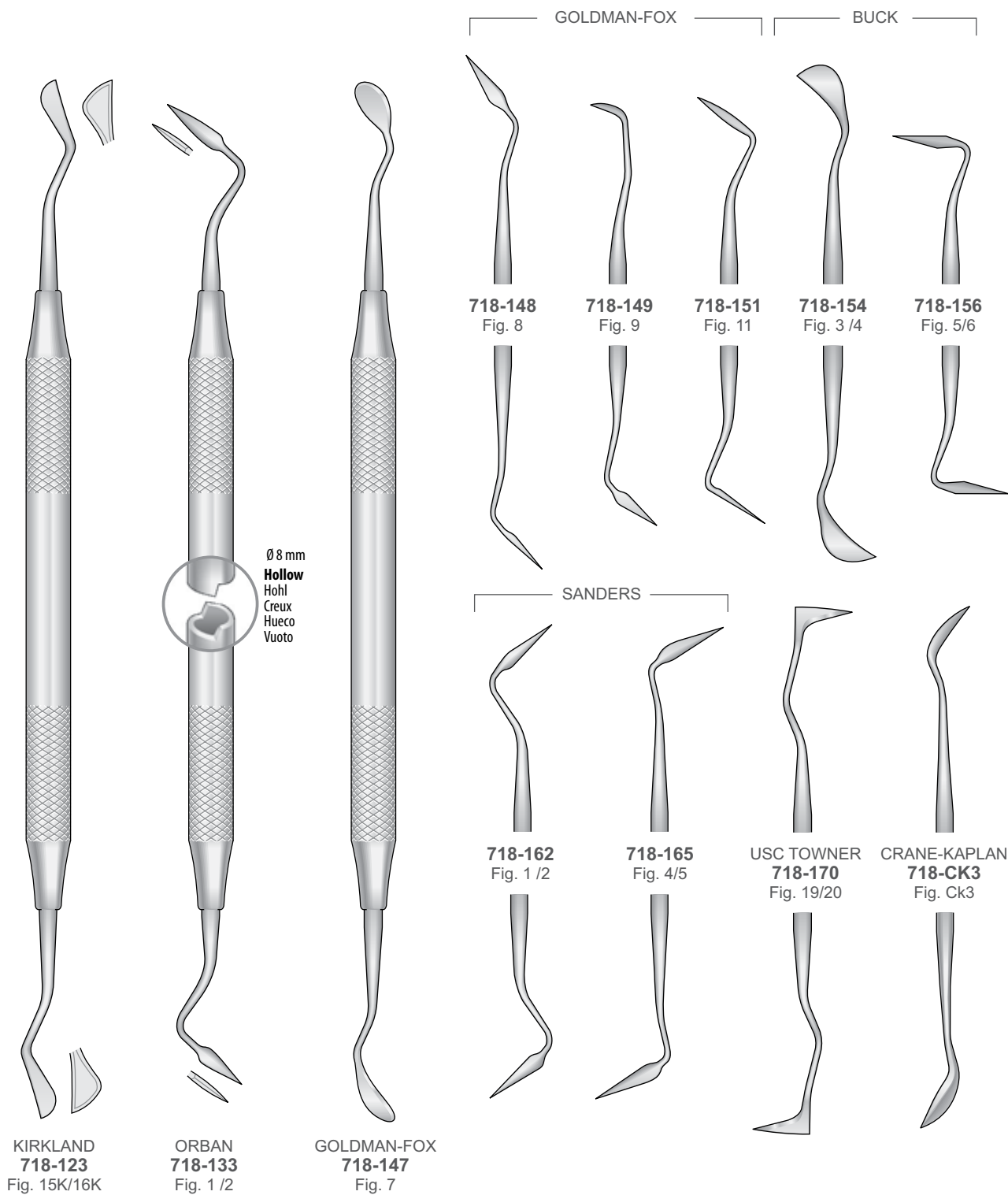

Curettes

Küretten
Curette
Curetas
Curettes

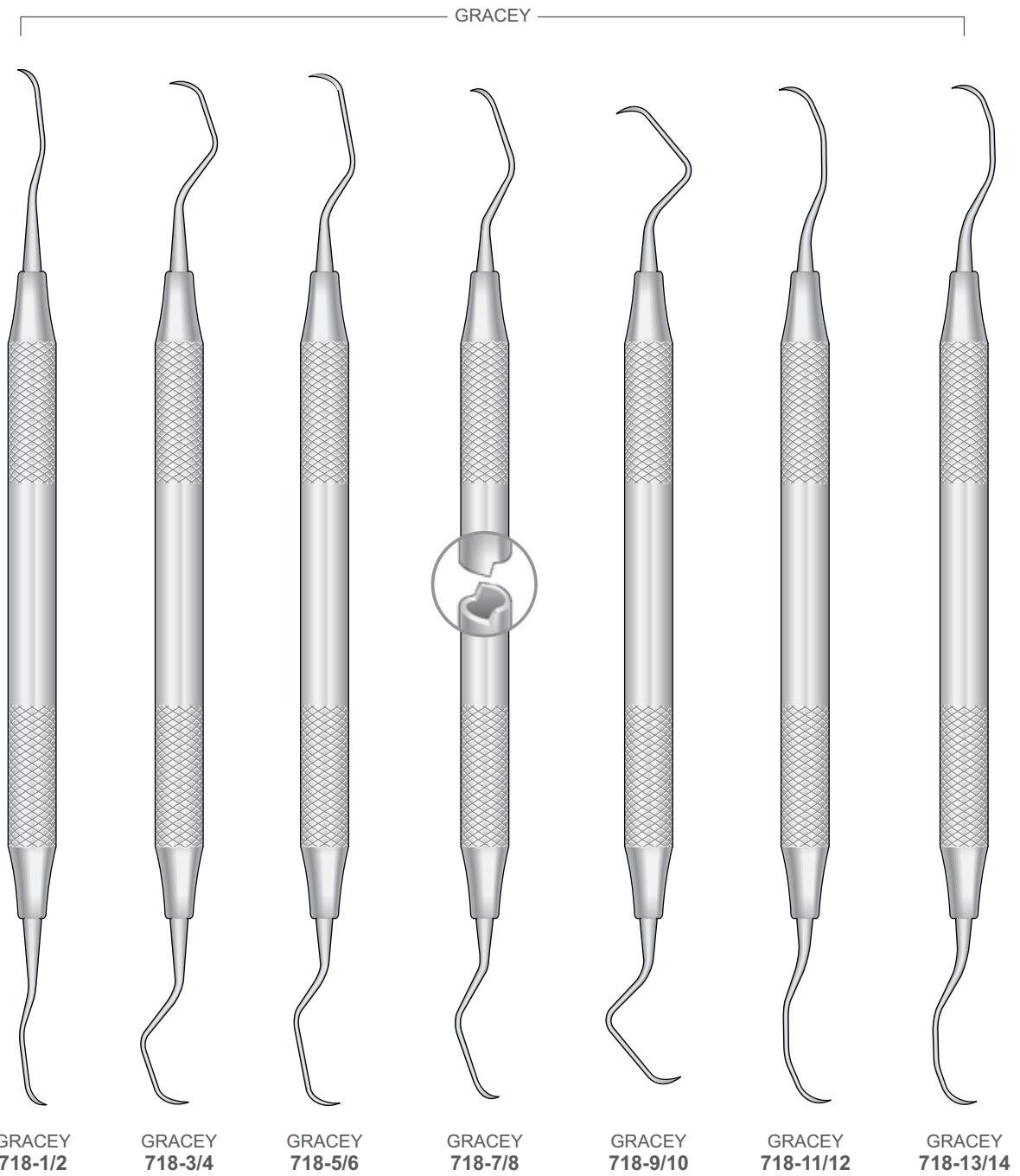

Curettes

Küretten
Curette
Curetas
Curettes

Periodontics / Endodontics / Restoration

Parodontologie / Endodontie / Restauration
Parodontie / Endodontie / Restauration
Parodontologia / Endodonzia / Restauro
Parodontologiya / Endodontiya / Restavratsiya

Mesial - Distal

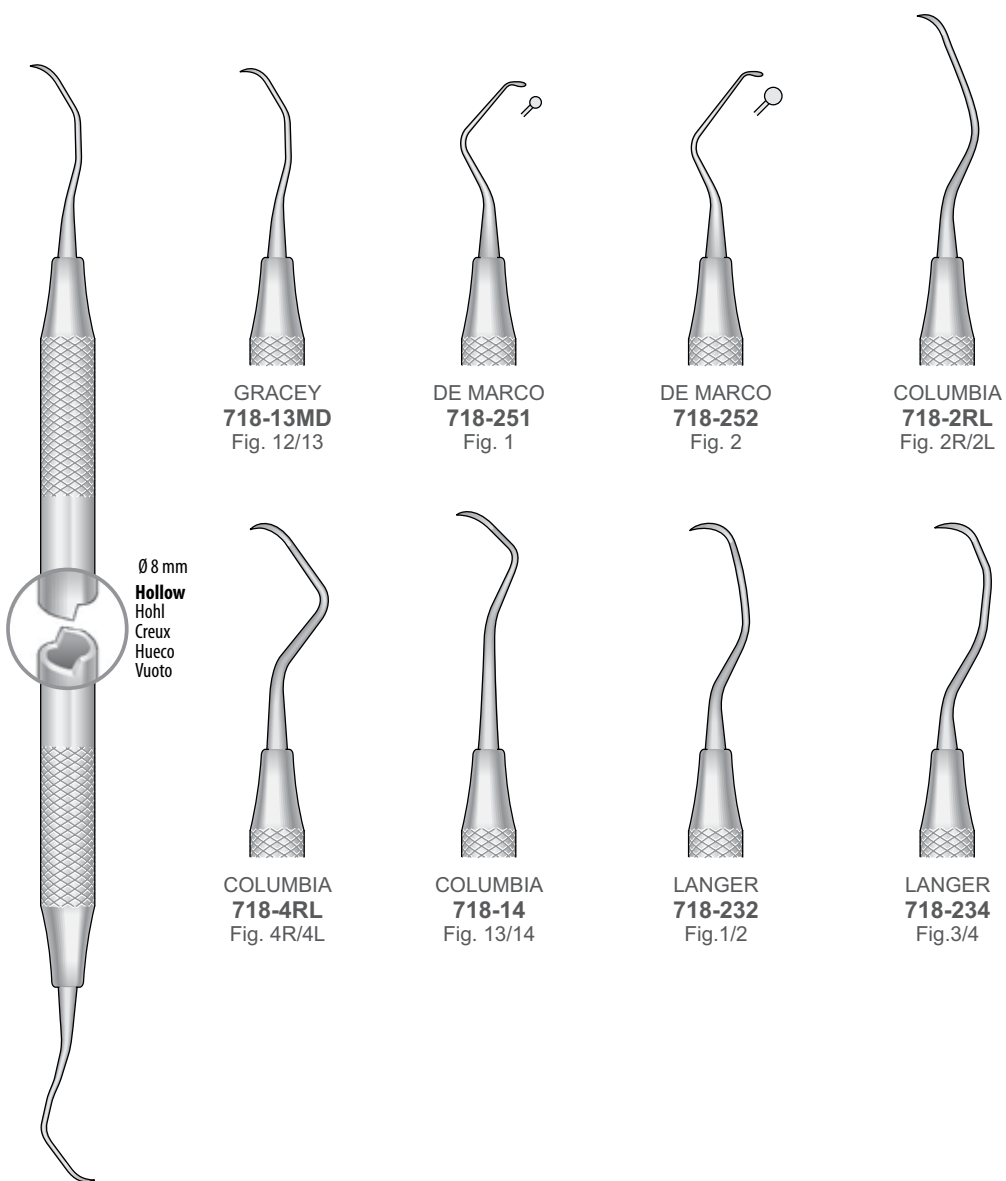

GRACEY
718-11MD
Fig. 11/14

Curettes

Küretten
Curette
Curetas
Curettes

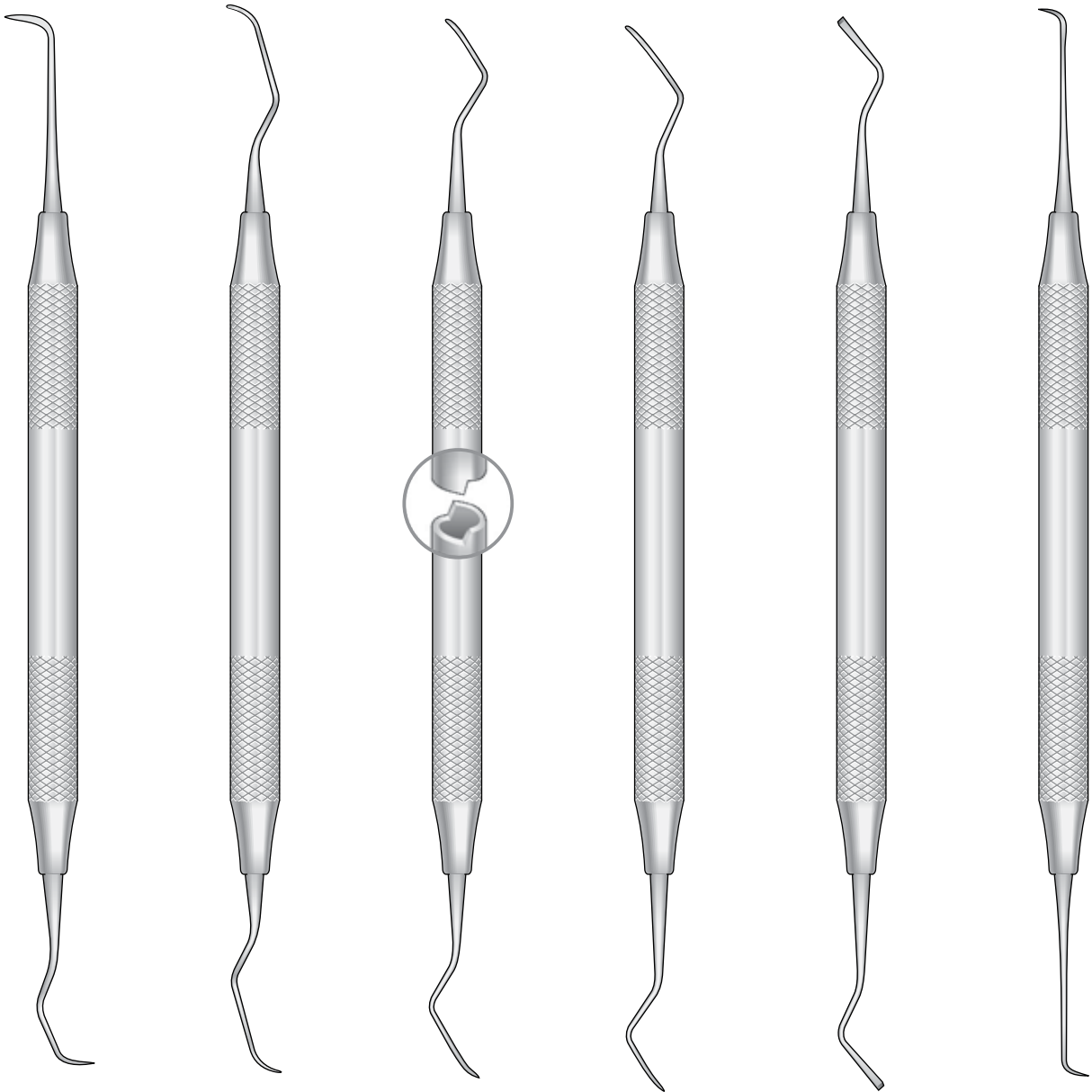

GOLDMAN-FOX
718-271
Fig. 1

GOLDMAN-FOX
718-272
Fig. 2

GOLDMAN-FOX
718-273
Fig. 3

GOLDMAN-FOX
718-274
Fig. 4

GOLDMAN-FOX
718-275
Fig. 5

GOLDMAN-FOX
718-277
Fig. 21

Scalers and Curettes

Scaler und Küretten

Scaler e Curette

Raspadores y Curetas

Détartreurs et Curettes

Periodontics / Endodontics / Restoration

Parodontologie / Endodontie / Restauration

Parodontie / Endodontie / Restauration

Parodontologia / Endodonzia / Restauro

Parodontologiya / Endodontiya / Restavratsiya

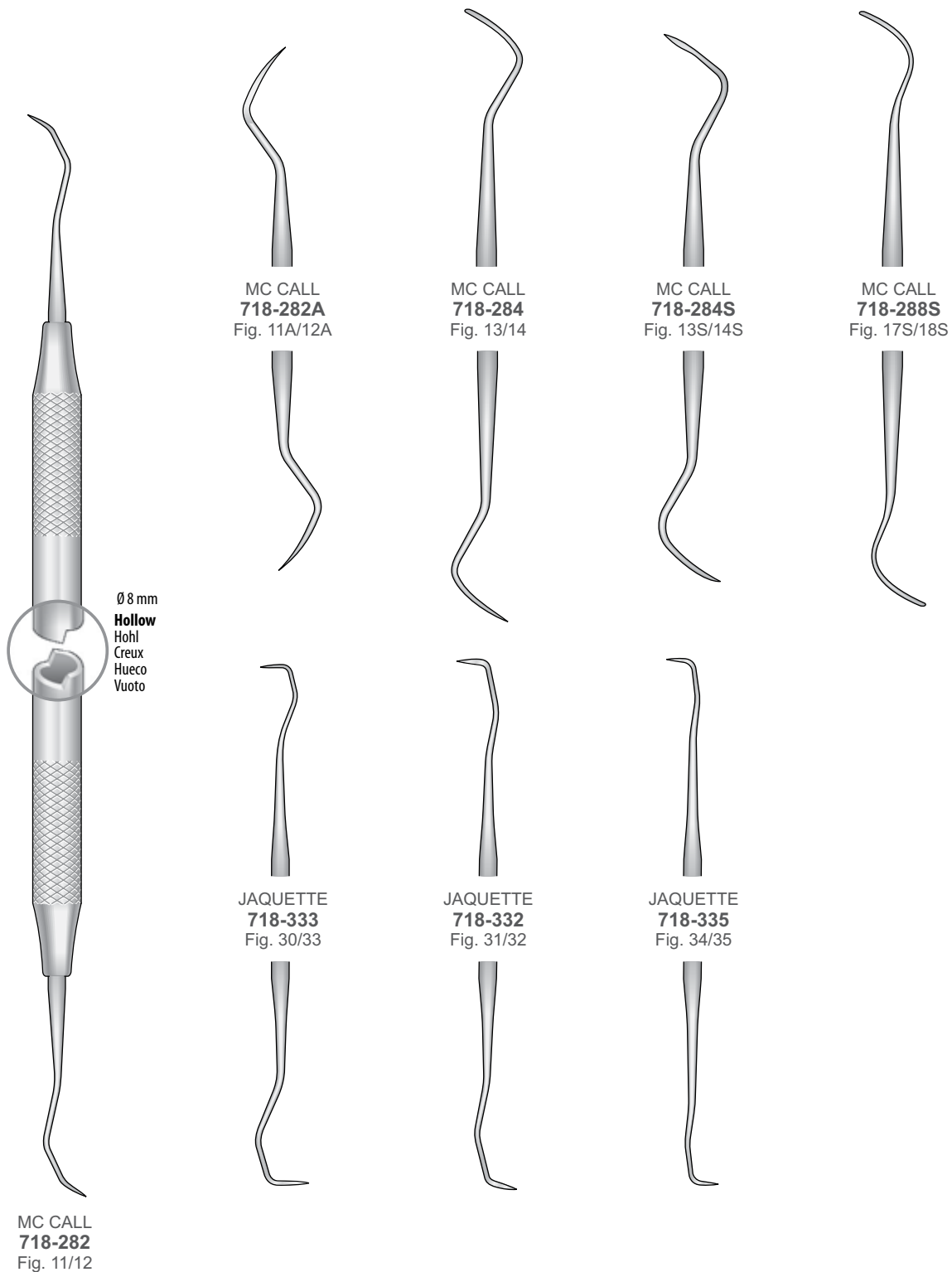

Scalers and Curettes

Scaler und Küretten
Scaler e Curette
Raspadores y Curetas
Dértartreurs et Curettes

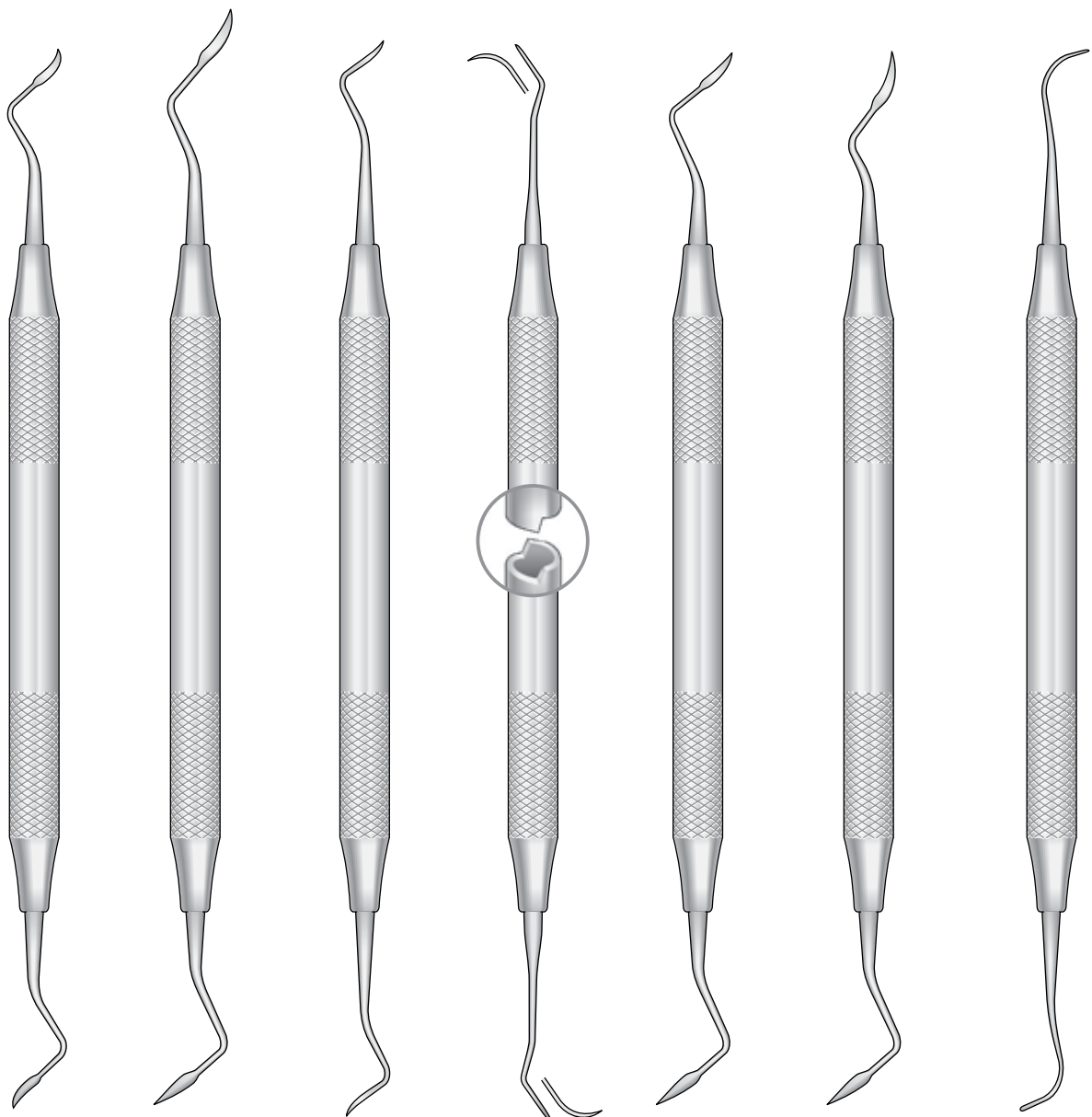

TAYLOR
718-TO3
Fig. 2/3

718-204
Fig. 204

718-204S
Fig. 204S

718-204SD
Fig. 204SD

718-CIO3
Fig. 2/3

CRANE-CAPLAN
718-CK6
Fig. 6

YOUNGER-GOOD
718-YGO8
Fig. 7/8

Scalers and Curettes

Scaler und Küretten
Scaler e Curette
Raspadores y Curetas
Détartreurs et Curettes

Periodontics / Endodontics / Restoration

Parodontologie / Endodontie / Restauration
Parodontie / Endodontie / Restauration
Parodontologia / Endodonzia / Restauro
Parodontologiya / Endodontiya / Restavratsiya



RULE 23/24
718-RO4
Fig. 3 /4



I. UNIVERSITY
718-268
Fig. 17/18



TOWNER-JAQUETTE
719-111
Fig. U15/33

Ø 8 mm
Hollow
Hohl
Creux
Hueco
Vuoto



TOWNER-JAQUETTE
719-125
Fig. H5/33



TOWNER-JAQUETTE
719-126
Fig. H6/H7

Rubber-Dam Instruments

Kofferdam Instrumente

Strumenti per diga

Instrumentos para dique de goma

Instrumentes pour digue de caoutchouc

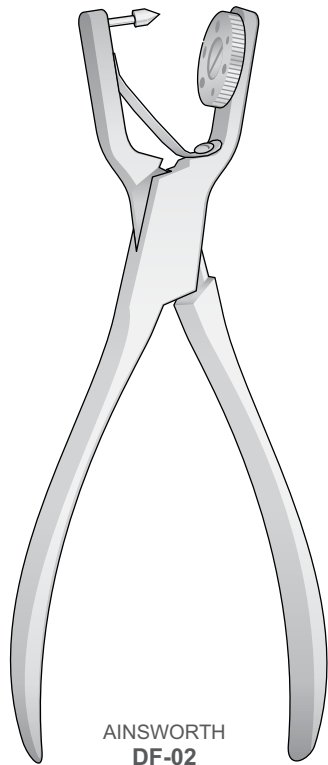

AINSWORTH
DF-02
160 mm

Lochzangen
Punch Forceps
Pinze foradiga
Perforadores
Pincés à perforer

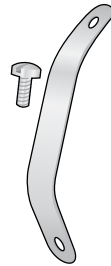

DF-02M
Feder mit Schraube
Spring with screw
Molla con vite
Muelle con tornillo
Ressort avec vis



DF-02R
Lochscheibe
Punch Disk
Disco divisor
Disco agujereado
Disque perforé



DF-02P
Stift, mit Schraube
Pin, with screw
Perno con vite
Punzón con perno
Broche

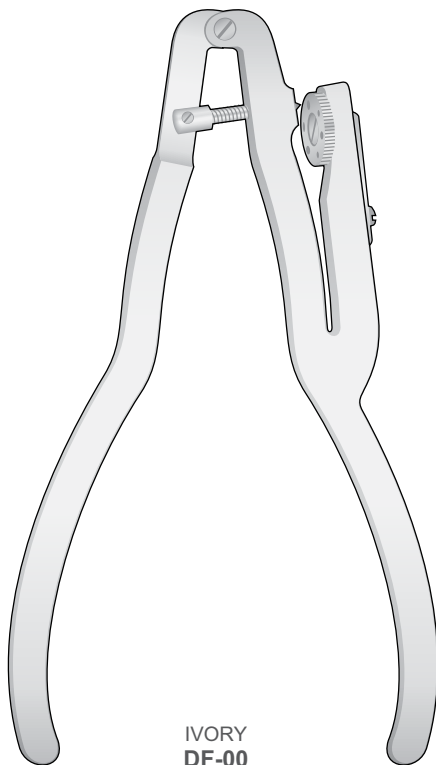

IVORY
DF-00
160 mm

Lochzangen
Punch Forceps
Pinze foradiga
Perforadores
Pincés à perforer



DF-00M
Spiralfeder
Spiral Spring
Molla a spirale
Muelle espiral
Ressort en spirale



DF-00L + DF-00V
Feder mit Schraube
Spring with screw
Molla con vite
Muelle con tornillo
Ressort avec vis



DF-00R
Lochscheibe
Punch Disk
Disco divisor
Disco agujereado
Disque perforé



DF-00P + DF-00N
Stift, mit Schraube
Pin, with screw
Perno con vite
Punzón con perno
Broche avec vis

Rubber-Dam Clamp Forceps

Kofferdam-Klammerzangen

Pinze per uncini

Pinzas para grapas dique de goma

Pinces porte-crampons

Periodontics / Endodontics / Restoration

Parodontologie / Endodontie / Restauration

Parodontie / Endodontie / Restauration

Parodontologia / Endodonzia / Restauro

Parodontologiya / Endodontiya / Restavratsiya

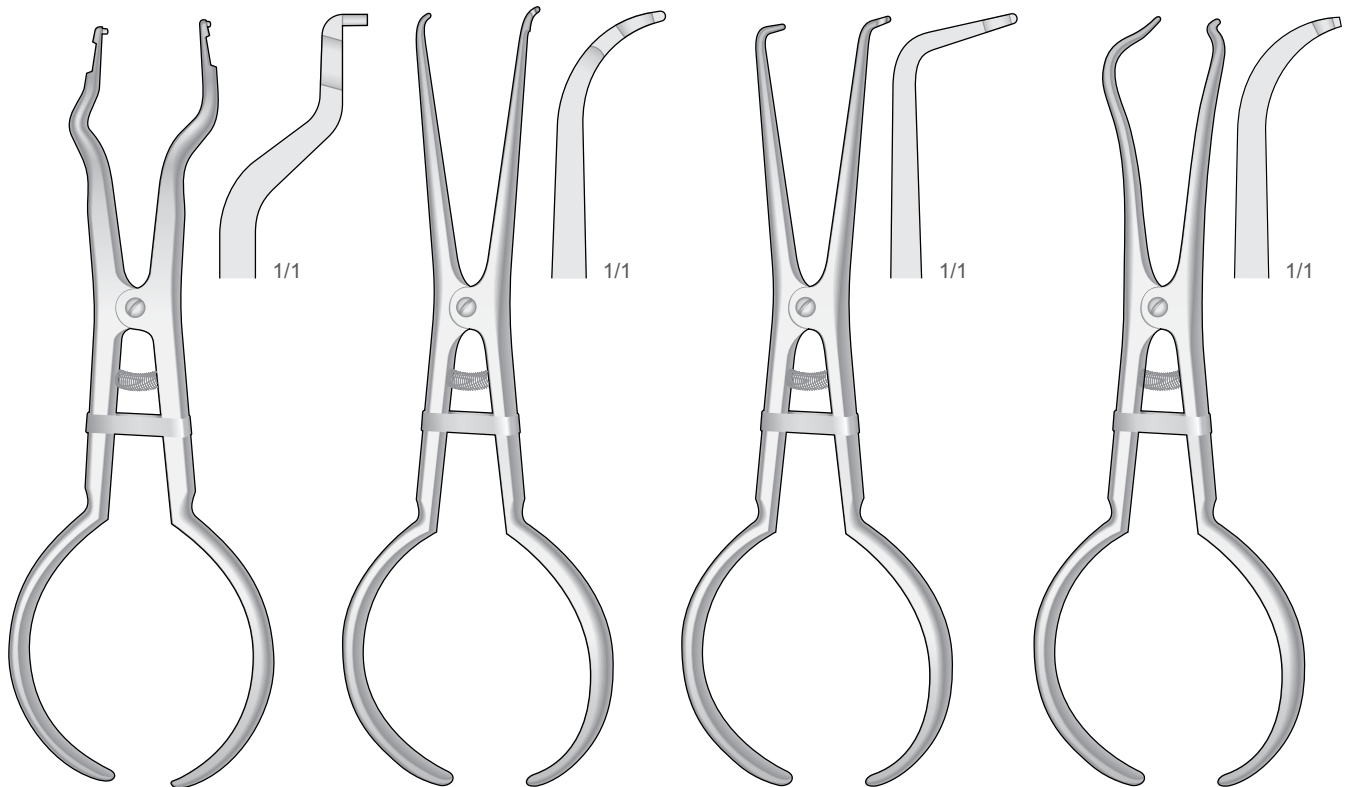

BREWER
DF-10
170 mm

PALMER
DF-15
170 mm

STOKE
DF-16
170 mm

DF-18
170 mm

Matrix Retainers and Matrix Bands

Matrizenspanner und Matrizenbänder
 Portamatrici e matrici
 Portamatrices y bandas matrices
 Porte-matrices et bagues matrices

Molaren, 12 Stück
 Molars, 12 pieces
 Molari, 12 pezzi
 Molares, 12 piezas
 Molaïres, 12 Pièces

Premolaren, 12 Stück
 Premolars, 12 pieces
 Premolari, 12 pezzi
 Premolares, 12 piezas
 Prémolaires, 12 Pièces



DF-40/1
 Fig.1



DF-41/4
 Fig.4



DF-40/2
 Fig.2



DF-41/5
 Fig.5



DF-40/3
 Fig.3



DF-41/6
 Fig.6

Kofferdam-Klammerzangen
 Rubber-Dam Clamp Forceps
 Pinze per uncini
 Pinzas para grapas dique de goma
 Pincas porte-crampons

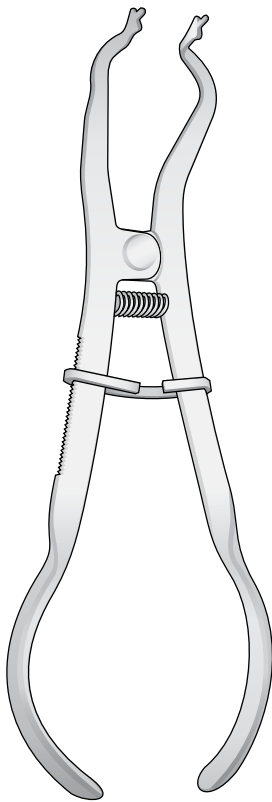

IVORY
DF-12
 170 mm

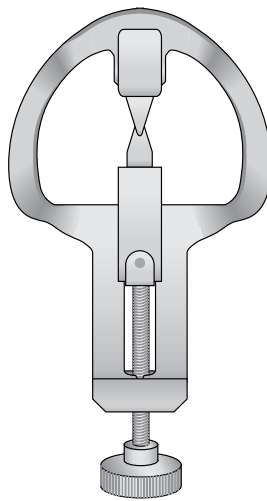

IVORY
DF-43
 Fig. 14

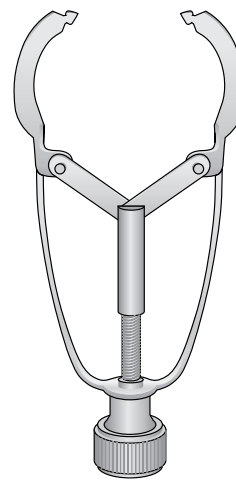

IVORY
DF-40
 Fig. 1

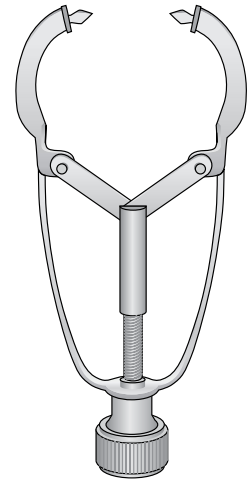

IVORY
DF-41
 Fig. 12

Rubber-Dam Instruments

Kofferdam Instrumente
Strumenti per diga
Instrumentos para dique de goma
Instruments pour digue de caoutchouc

Periodontics / Endodontics / Restoration

Parodontologie / Endodontie / Restauration
Parodontie / Endodontie / Restauration
Parodontologia / Endodonzia / Restauro
Parodontologiya / Endodontiya / Restavratsiya

Kofferdam-Klammern
Rubber-Dam Clamps
Uncini per diga
Clamps para diques
Crampons pour digue



IVORY
DF-126
26



IVORY
DF-127
27



IVORY
DF-128
28



IVORY
DF-129
29



IVORY
DF-130
30



IVORY
DF-131
31



IVORY
DF-151
51



IVORY
DF-160
60

Kofferdam-Rahmen
Rubber-Dam Frames
Telaio per diga
Cuadro para diques
Cadre à digue

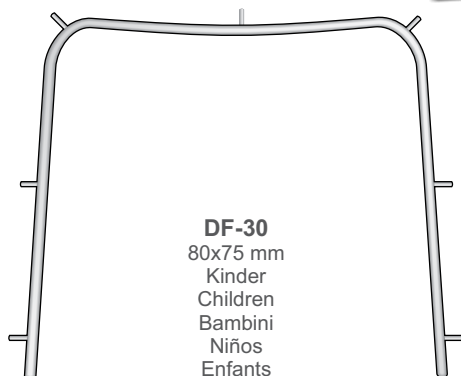

DF-30
80x75 mm
Kinder
Children
Bambini
Niños
Enfants

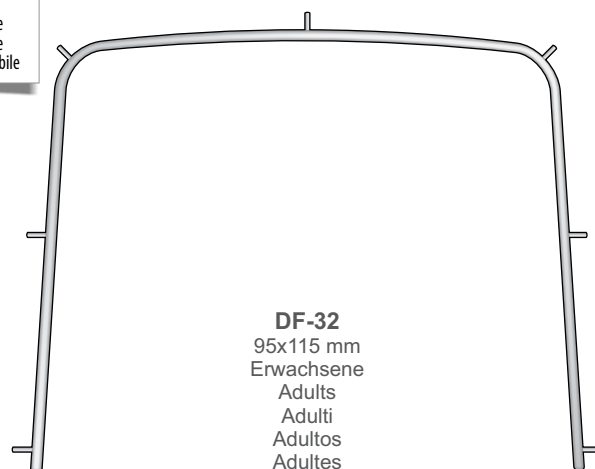

DF-32
95x115 mm
Erwachsene
Adults
Adulti
Adultos
Adultes

Matrix Retainers and Matrix Bands

Matrizenspanner und Matrizenbänder
 Portamatrici e matrici
 Portamatrices y bandas matrices
 Porte-matrices et bagues matrices

Molaren, 12 Stück
 Molars, 12 pieces
 Molari, 12 pezzi
 Molares, 12 piezas
 Molaires, 12 Pièces

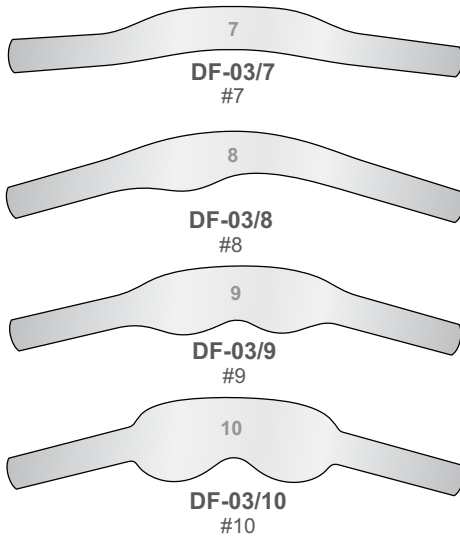

Premolaren, 12 Stück
 Premolars, 12 pieces
 Premolari, 12 pezzi
 Premolares, 12 piezas
 Prémolaires, 12 Pièces

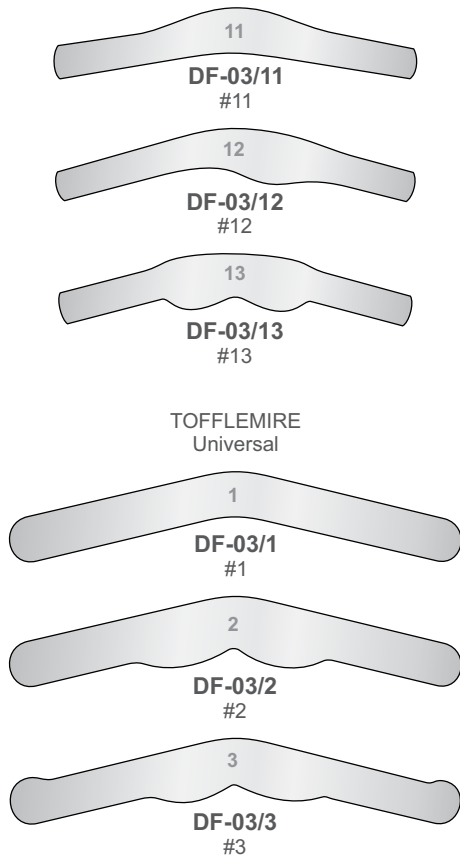

DF-01/5 5 mm x 1 mt
 DF-01/6 6 mm x 1 mt
 DF-01/7 7 mm x 1 mt



DF-05/5 5 mm x 5 mt
 DF-05/6 6 mm x 5 mt
 DF-05/7 7 mm x 5 mt

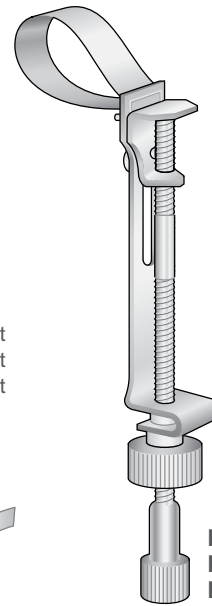

DF-06 5 mm
 DF-08 6 mm
 DF-09 7 mm
 IVORY
 DF-06/DF-09
 #8

Paar - Pair
 Coppia - Par
 Paire

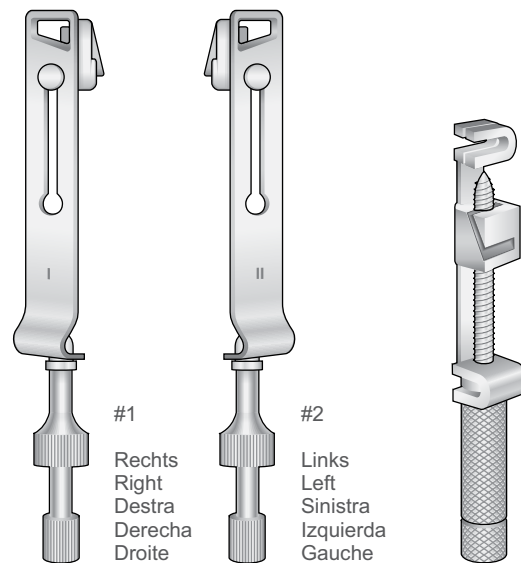

#1
 Rechts
 Right
 Destra
 Derecha
 Droite
 #2
 Links
 Left
 Sinistra
 Izquierda
 Gauche

NYSTRÖM
 DF-04
 #1 + #2

TOFFLEMIRE
 DF-07
 Universal

MSB

CROWN BRIDGE



Crown Instruments

Kroneninstrumente
Pinze per corone
Alicates para coronas
Pinces pour couronnes

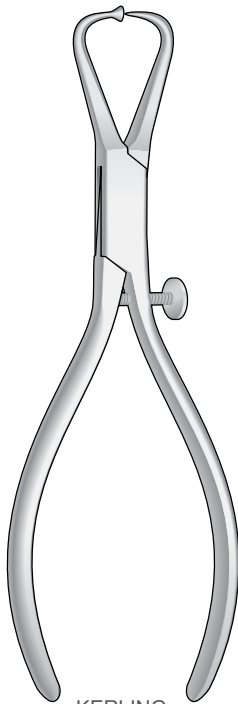

**KERLING
DP-38A**
145 mm

Kupferringabnehmmezange
Copper Ring Removing Pliers
Pinza per togliere anelli di rame
Pinza para sacar anillos de cobre
Pince à enlever les bagues en cuivre

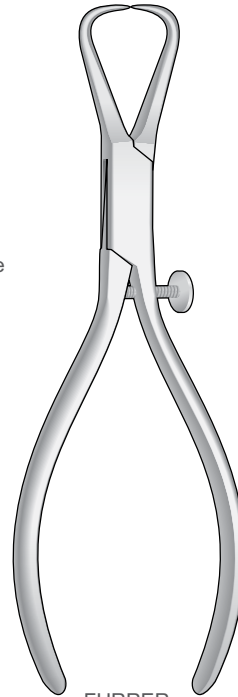

**FURRER
DP-38**
145 mm

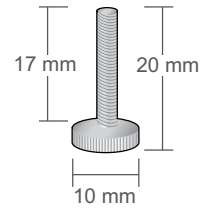

DP-38R
Schraube
Replacement Screw
Vite di ricambio
Tornillos de recambio
Vis de rechange

Teleskopkronenzangen - Pliers for telescope crowns
Pinze per corone telescopiche - Alicates para coronas telescópicas
Pinces pour couronnes telescopes

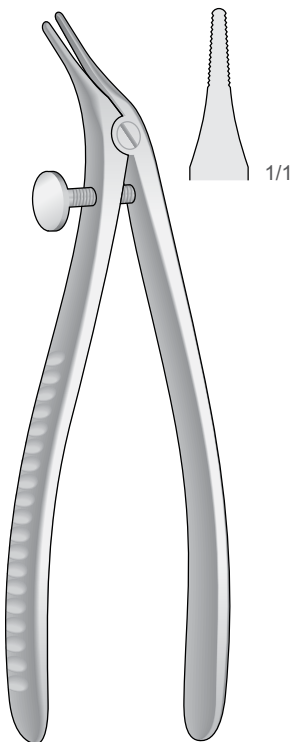

**BÖHM
DP-28**
150 mm

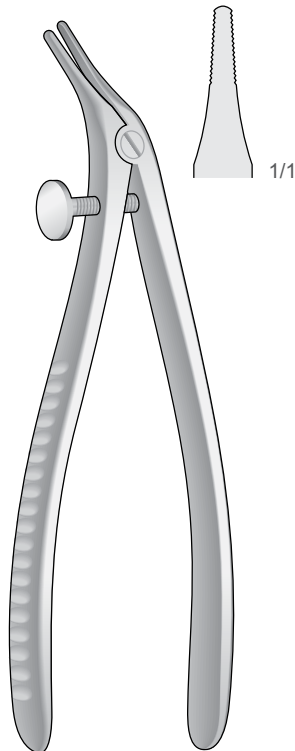

**BÖHM
DP-29**
150 mm

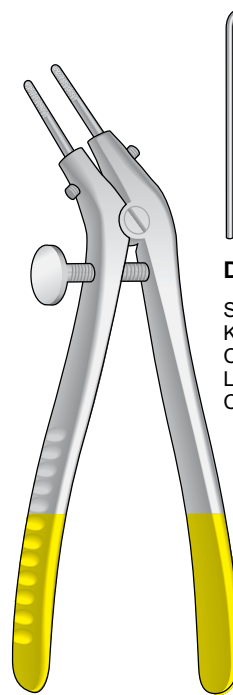

DP-24
120 mm



DP-24C
Schlüssel
Key
Chiavetta
Llave
Clé



DP-24R
Diamantierte Einsätze, paar
Diamond inserts, pairs
Punte diamantate, coppia
Puntas diamantadas, par
Pointes diamantées, pair

Crown Instruments

Kronen Instrumente
Strumenti per corone
Instrumentos para coronas
Instruments pour couronnes

Crown and Bridge

Krone und Brücke
Couronne et pont
Corona e Ponte
Korona i most

MRT-C7
Complete Bridge Extractor
MRT-7 + C-71 + C-72 + C-73 + C-74

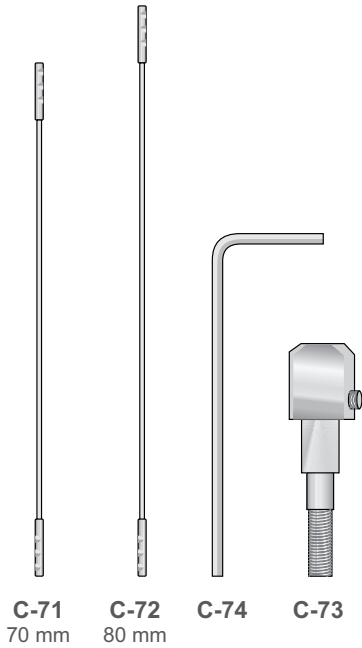

Removing pliers
for temporary
bridges and crowns



Tungsten-Carbide Inserts
Mit Hartmetalleinsätzen
Plaquettes en carbure de tungstène
Plaquetas de carburo de tungsteno
Inserti in carburo di tungsteno

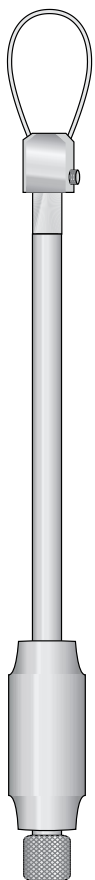

MRT/C7

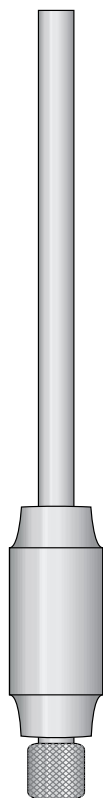

MRT-7

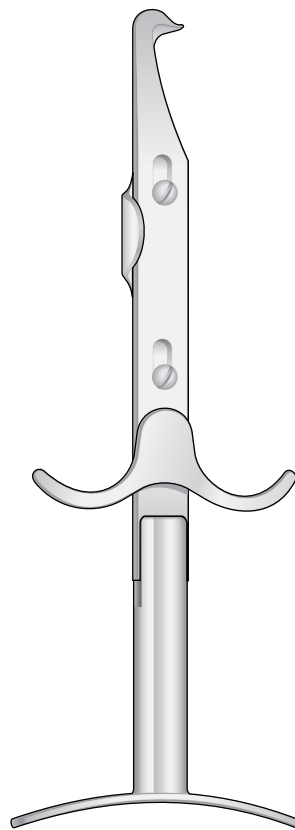

MRT-6
170 mm

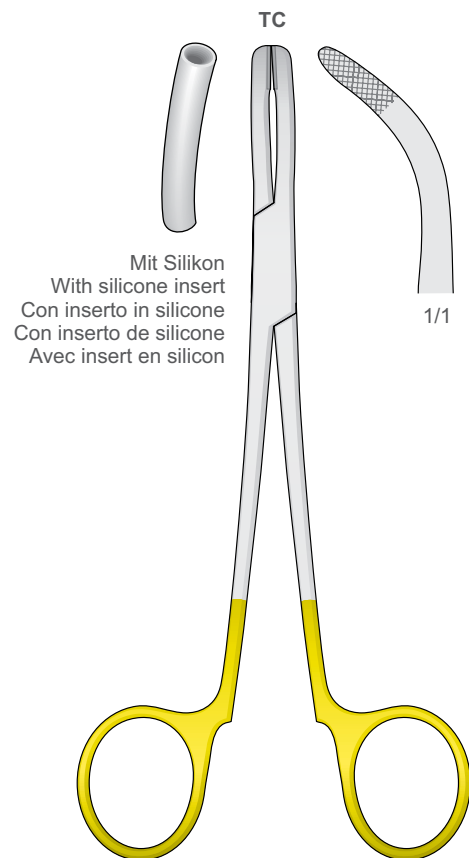

PH-60
170 mm

Mit Silikon
With silicone insert
Con inserto in silicone
Con inserto de silicone
Avec insert en silicon

1/1

Crown Removers

Kronenentferner

Leva corone

Removedor de coronas

Enlève-couronne

Enlève-couronne

MRT-C3
Complete with 3 Attachments
C-34 + C-35 + C-36

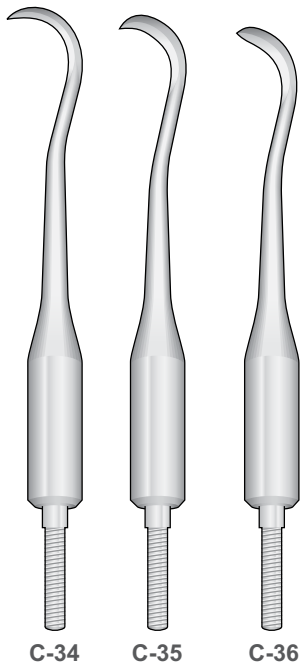

MRT-C4
Complete with 3 Attachments
C-41 + C-42 + C-43

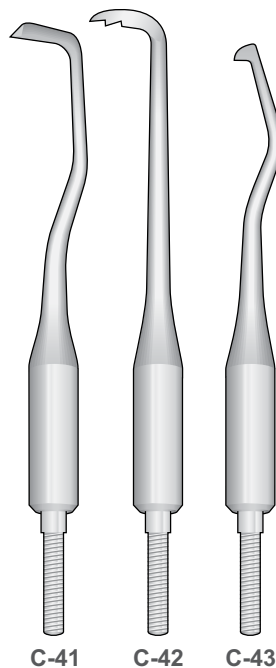

MRT-C1
Complete with 3 Attachments
C-11 + C-12 + C-13

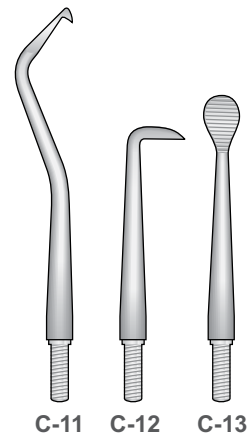

Usando la punta C-30
e invertendo la molla
si usa come spingicorone

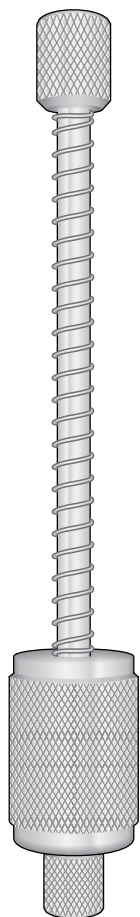

MRT-C3



MRT-C4

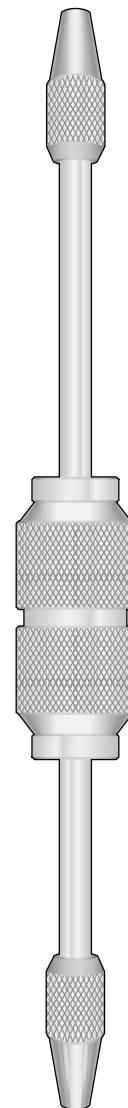

MRT-C1

Crown Removers

Kronentferner
Leva corone
Removedor de coronas
Enlève-couronne

Crown and Bridge

Krone und Brücke
Couronne et pont
Corona e Ponte
Korona i most

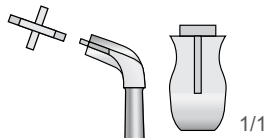

UNIVERSAL
DL-60
150 mm

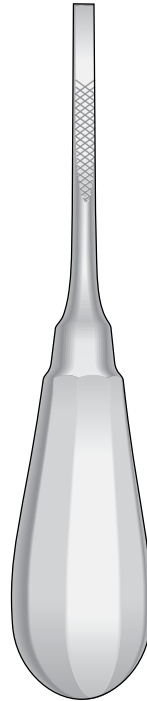

DL-C
140 mm



DL-V
130 mm

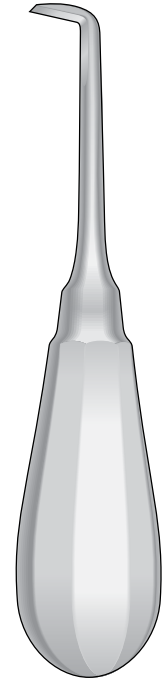

DL-0
130 mm

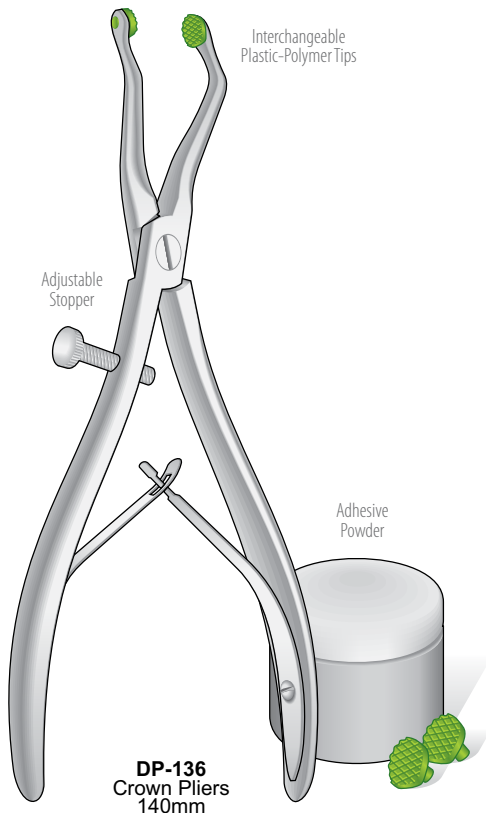

DP-136
Crown Pliers
140mm

TEMPORARY CROWN PLACEMENT KIT | DP-136

1 Crown Pliers + 20 Replacement Tips + 10g Adhesive Powder

Crown Pliers: designed to remove upper and lower crowns and bridges. An adjustable stopper allows to adjust the grasping tips to the width of the crown and locking into place. It will prevent any unwanted pressures to the crown avoiding potential damages. The double spring back action along with the hook-lock mechanism allows for a smooth grasping motion.

Polymer Plastic Replacement Tips: provide a perfect and safely grip for temporary ceramic crowns without damaging metal, resin, or ceramic surfaces. A better grip of the crown can be achieved if the tips are coated with the supplied adhesive powder which is dampened by saliva.

Adhesive Powder: denture adhesive used as "glue" for recementing crowns or bridges that have come off.

DP-137 / Replacement Kit for DP-136: 20 Replacement Tips + 10g Adhesive Powder



Phone: **+92-52-3251901**
+92-3008622707 📞
+92-3338622707 📞

Emails: **info@modern-surgical.com**
sales@modern-surgical.com

Address: **Small Industrial Estate,
Tipu Road, Sialkot Pakistan**

